

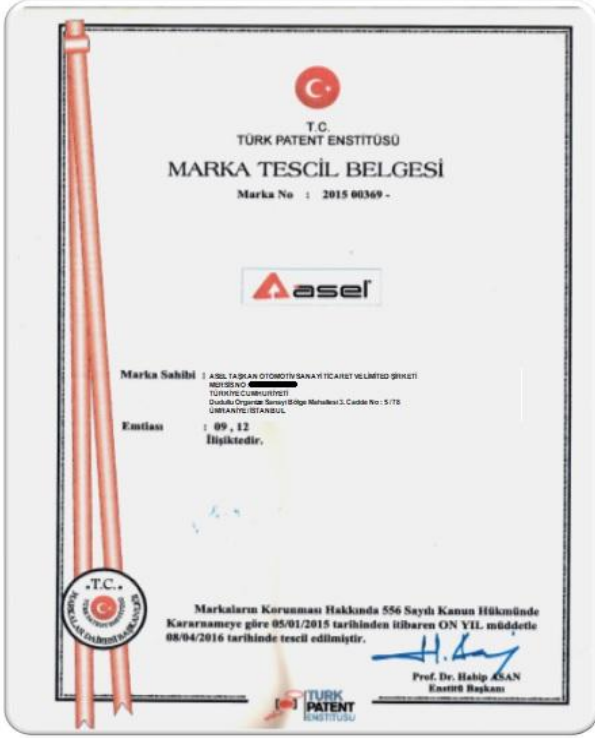

High Quality Air Disc Brake Caliper Components



Sertifikalar / Certificates / شهادة



HAKKIMIZDA

Asel Air Brake Systems 2012 yılında İstanbul'da yük ve yolcu taşımacılığında kullanılan ticari araçların fren aksamalarında ki havalı fren sistemine ait parçaların üretimini yapmak için kurulmuştur.

Kısa zaman içerisinde kalitesi ve uygun fiyat politikasıyla adından söz ettirerek yurt içi ve yurt dışı pazarında yer almıştır.

Asel yük ve yolcu taşımacılığında kullanılan araçların havalı fren kompresörlerini ve yedek parçaları olan; silindir kapak, pleyt , kompresör gövdesi , krank mili, piston kolu , piston segmanı , piston , dişli , burç , valf takımı , tamir takımı ve conta takımı üretimlerini yaparak 4 kıtada 35 den fazla ülkeye ihraç etmektedir.

Firmamız otomotiv sektöründe önemli bir rolü olan TS EN ISO 9001:2008 ile TSE ISO EN 9000 kalite uygunluk ve yönetim belgelerine sahiptir.



VİZYONUMUZ

Sürekli gelişme ve iyileştirme ilkesi doğrultusunda; Küresel pazarın talepleri doğrultusunda değerler ile sürdürülebilir büyümesini koruyan

Yurt içi ve yurt dışı OEM ile after market satışlarında müşteri memnuniyeti odaklı çalışma prensibiyle istikrarlı bir şekilde büyümeye devam etmeyi amaçlamaktadır. satış ve satış sonrası hizmet ağıyla kaliteli , rekabet gücü yüksek , güvenilir , çevre ve insana duyarlı olarak otomotiv yedek parça pazarında Türk Otomotiv Sanayisinde en değerli ve en çok tercih edilen başarılı bir sanayi şirketi olmak



MİSYONUMUZ

Basınçlı hava sistemleri alanında Türk sanayii başta olmak üzere yurt içi ve yurt dışındaki müşterilerine katma değeri yüksek, yenilikçi , güvenilir ürün ve çözümleri sunarak küresel hedeflerine marka bilinirliğini artırarak kurumsallaşma, en iyi istihdam personel ve ekipmanlara yatırım yaparak ürünlerimizi kullanan herkesin yüksek performans ve kalite beklentisini karşılamak bilinciyle çalışmakta ve bu bilinci tüm ekip arkadaşlarımız ve siz değerli müşterilerimiz ile paylaşmaktayız.

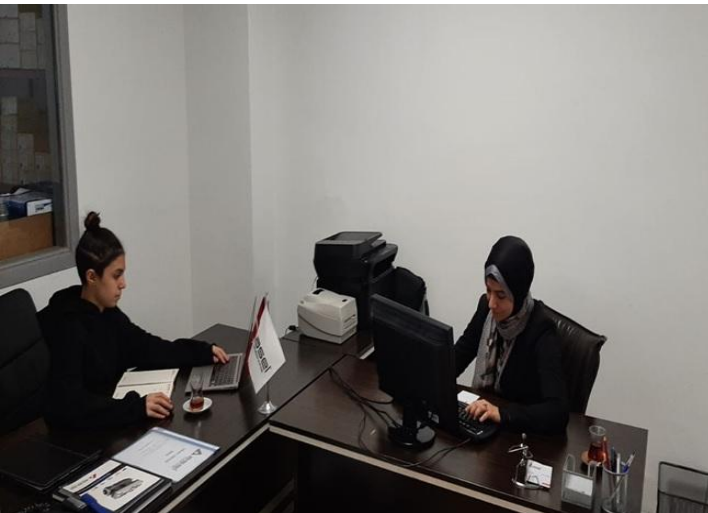

DEĞERLERİMİZ

Başarımız, temel değerlere dayanır:

- İnsana ve çevreye saygılı,
- Takım Ruhu ve Bütünlük.
- Toplam kalite prensiplerini benimsemiş
- Güvenilir , Dürüst,
- Önce Müşteri ve Bireye Saygı
- Çözüm odaklı
- Sürekli daha iyi olmanın gerekliliğine inanarak kendini geliştirmeyi amaç edinmiş
- Müşteri memnuniyetinin para kazanmaktan daha önemli olduğunu bilen bir firmayız.

ABOUT US

Asel Air Brake Systems was established in 2012 in Istanbul to produce parts of the air brake system in the brake components of commercial vehicles used in freight and passenger transportation

In a short time, it made a name for itself with its quality and reasonable price policy and took its place in the domestic and international markets

Asel air brake compressors and spare parts of vehicles used in freight and passenger transportation produces; cylinder head, plate, compressor body, crankshaft, piston rod, piston ring, piston, gear, bushing, valve set, repair kit and gasket kit and exports them to more than 35 countries in 4 continents

Our company has TS EN ISO 9001:2008 and TSE ISO EN 9000 quality conformity and management certificates, which have an important role in the automotive industry.

VISION

In line with the principle of continuous development and improvement;

Maintaining its sustainable growth with values in line with the demands of the global market

With domestic and international OEM aims to continue to grow steadily with the principle of working with a focus on customer satisfaction in after-market sales.

To be the most valuable and most preferred successful industrial company in the Turkish Automotive Industry in the automotive spare parts market, with its sales and after-sales service network, by being high quality, competitive, reliable, sensitive to the environment and people



MISSION

In the field of compressed air systems, by offering high value-added, innovative, reliable products and solutions to domestic and foreign customers, especially the Turkish industry, institutionalization by increasing brand awareness for its global goals, best employment personnel and we work with the awareness of meeting the high performance and quality expectations of everyone who uses our products by investing in equipment, and we share this awareness with all our teammates and our valued customers.



OUR VALUES

Our success is based on core values:

- Respectful to people and the environment.
- Team Spirit and Integrity.
- It has adopted the principles of total quality.
- Reliable and Honest.
- Respect for Customer and Individual First.
- Solution oriented.
- Believing in the necessity of being better all the time, it aimed to improve itself.
- Knowing that customer satisfaction is more important than making money we are a company.



Montaj / Assambely

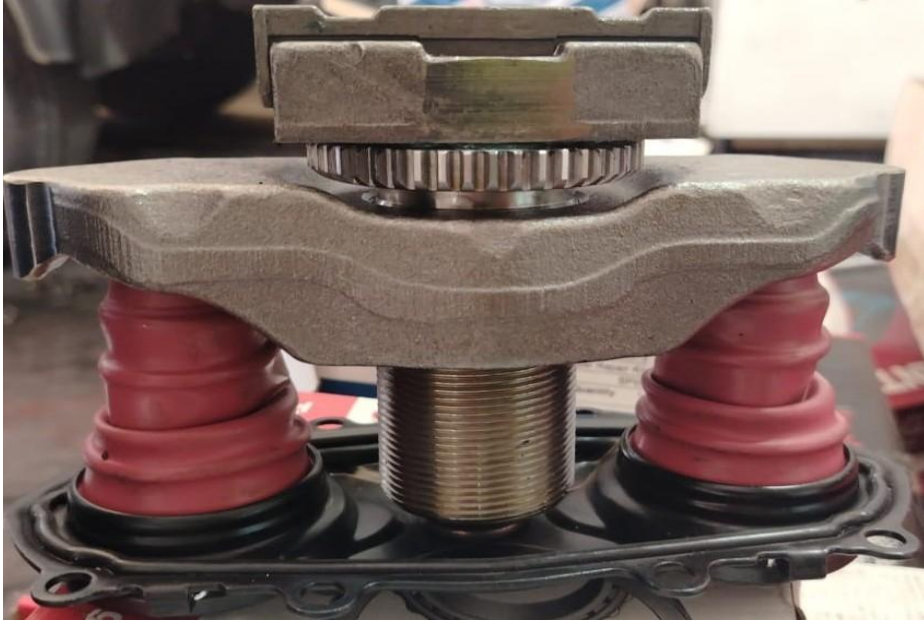

Paketleme / Packaging



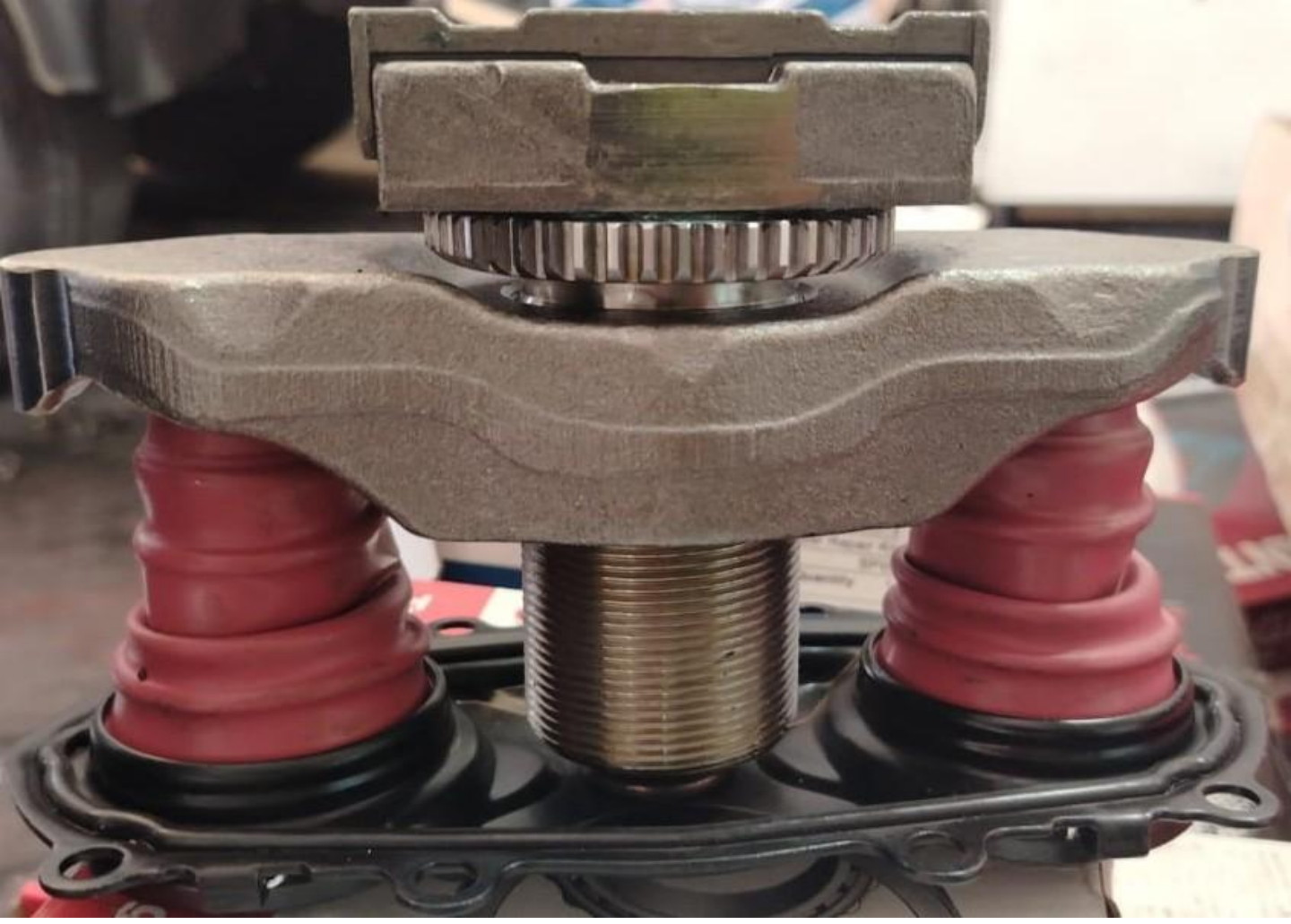

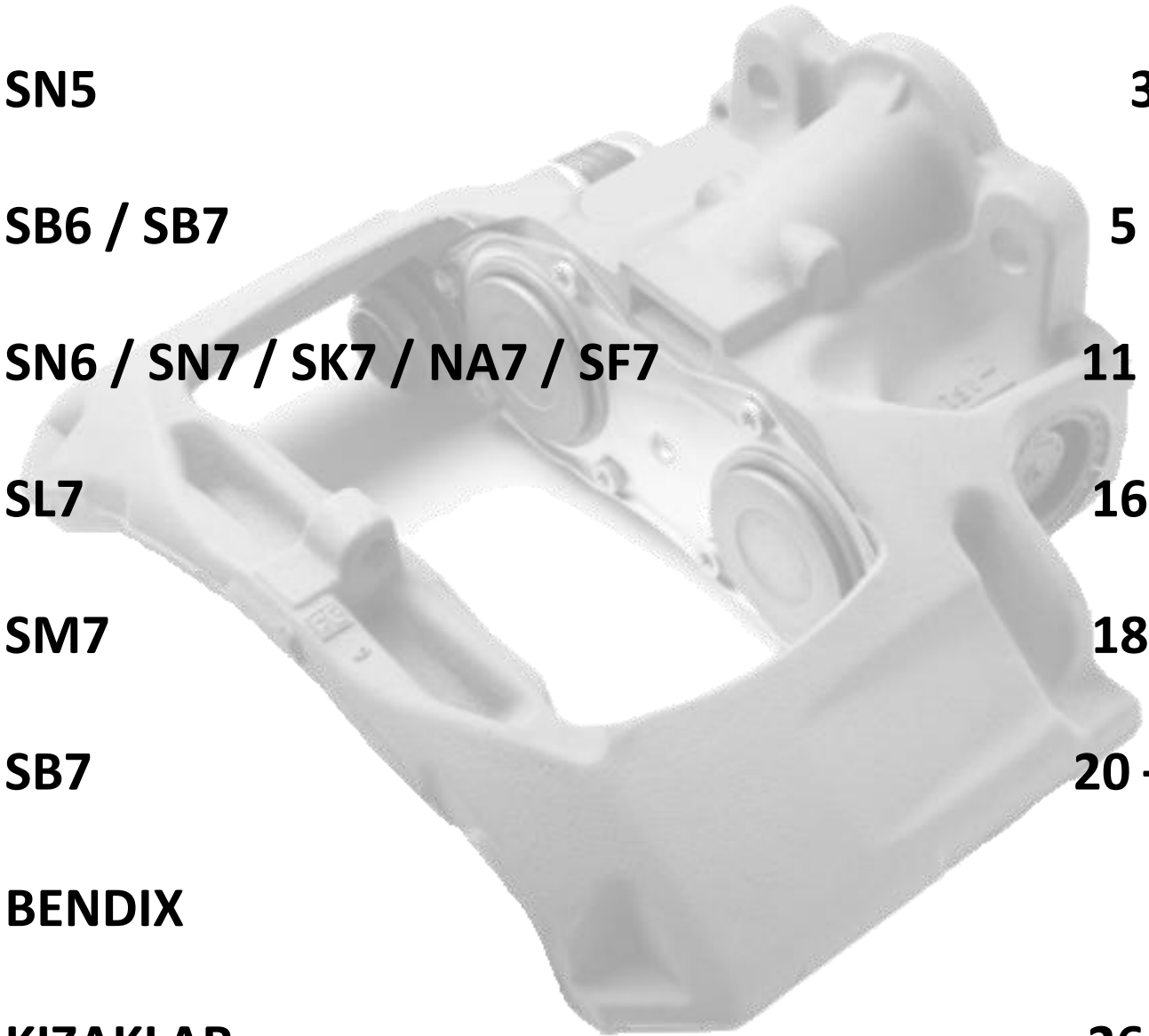

KNORR-BREMSE**SB5 1 – 2****SN5 3 – 4****SB6 / SB7 5 – 10****SN6 / SN7 / SK7 / NA7 / SF7 11 - 15****SL7 16 - 17****SM7 18 - 19****SB7 20 – 24****BENDIX 25****KIZAKLAR 26 - 27**

Ürün Kod Açıklaması / Product Code Description

ASEL CODE

01 01 001

01 01 001

MARKA

TYPE

Ürün Grubu / Product Group

01 - KNORR
02 - WABCO
03 - MERITOR
04 - HALDEX
05 - SAF
06 - BPW
07 - BREMBO HYD.
08 - IVECO
09 - Z-KAM

01 - SB5
02 - SN5
03 - SB6 - SB7
04 - SN6-SN7-SK7-NA7-
SF7 TYPE
05 - SL7
06 - SM7
07 - SB7
08 - BENDIX
09 - KIZAKLAR
10 - SETLER
11 - PAN
12 - 17 TYPE
13 - PAN 19 1 -22 -1 TYPE
14 - PAN 19 2 -22 -2 TYPE
15 - MAX 22

001 - 006 Kaliper Perno Tamir Takımı
007 - 011 Kaliper Tamir Takımı
012 - Kaliper Bilya (Rulman) Takımı
013 - Kaliper Ayar Civatası
014 - Kaliper Dişlisi
015 - Kaliper Dürbün
016 - Kaliper Zinciri (12 Bakla)
017 - Kaliper Masura Bilya Yatağı
018 - Kaliper Ayar Mekanizması
019 - Kaliper Lastik Takımı
020 - Kaliper Tapa Takımı
021 - Tapa Takımı
022 - Tapa Lastik Tamir Takımı
023 - Kaliper Balata Tutucu Tamir Takımı
024 - Kaliper Sensör Kapağı (Sensörsüz)
025 - Kaliper Sensör Kapağı (2 Kablololu)
026 - Kaliper Sensör Kapağı (3 Kablololu MN TGA)
027 - Kaliper Sensör Kapağı (3 Kablololu Mercedes)



KNORR

SB5 Type

01 01 001 Kaliper Perno Tamir Takımı



OEM Ref. II369100062 / II339680062 / 000 420 1282

01 01 003 Kaliper Perno Tamir Takımı



OEM Ref. II368470064

01 01 007 Kaliper Tamir Takımı



OEM Ref. II350470061

01 01 002 Kaliper Perno Tamir Takımı



OEM Ref. K000935

01 01 004 Kaliper Perno Tamir Takımı



OEM Ref. K00697

01 01 005 Kaliper Perno Tamir Takımı



OEM Ref. K001274 / K002716

01 01 008 Kaliper Tamir Takımı 74 mm



OEM Ref. II179320065 / II304130065

01 01 009 Kaliper Tamir Takımı 74 mm



OEM Ref. K000944 / K010604

01 01 012 Kaliper Bilya Takımı



OEM Ref.

01 01 013 Kaliper Ayar Civatası



OEM Ref.

01 01 014 Kaliper Dişlisi



OEM Ref.

01 01 015 Kaliper Dürbün



OEM Ref.

01 01 016 Kaliper Zinciri (12 Bakla)



OEM Ref.

01 01 017 Kaliper Masura Bilya Yatađı



OEM Ref. I1368470064

01 01 018 Kaliper Ayar Mekanizması



OEM Ref.

01 01 019 Kaliper Lastik Takımı



OEM Ref.

01 01 020 Kaliper Tapa Takımı



OEM Ref.

01 01 021 Tapa Takımı



OEM Ref.

01 01 022 Tapa Lastik Tamir Takımı



OEM Ref. K001301

01 01 023 Kaliper Balata Tutucu Tam. Tk.



OEM Ref.

01 01 041 Tapa Takımı



OEM Ref.

01 01 024 Kaliper Sensör Kapađı (Sensörsüz)



OEM Ref.

01 01 025 Kaliper Sensör Kapađı (2 Kablolu)



OEM Ref.

01 01 026 Kaliper Sensör Kapađı (3 Kablolu MAN)



OEM Ref.

01 01 027 Kaliper Sensör Kapađı (3 Kablolu MERCEDES)



OEM Ref.



KNORR

SN5 Type

01 02 001 Kaliper Perno Tamir Takımı



OEM Ref. K001928

01 02 007 Kaliper Tamir Takımı 69 mm



OEM Ref. K001929 – 000 420 4282 – 81.50822.6027

01 02 042 Kaliper Zinciri (14 Bakla)



OEM Ref.

01 01 013 Kaliper Ayar Civatası



OEM Ref.

01 02 018 Kaliper Ayar Mekanizması



OEM Ref.

01 02 012 Kaliper Bilya Takımı



OEM Ref.

01 02 028 Dürbün Tamir Takımı



OEM Ref.

01 02 014 Kaliper Dişlisi



OEM Ref.

01 02 017 Kaliper Masura Bilya Yatağı



OEM Ref.

01 02 043 Kaliper Ayar Mekanizması



OEM Ref.

01 02 029 Keçe Takımı



OEM Ref.

01 01 020 Kaliper Tapa Takımı



OEM Ref.

01 02 044

Dürbün Tamir Takımı



OEM Ref.

01 02 030

Kaliper Saç Kapak Takımı



OEM Ref.

01 01 023

Kaliper Balata Tutucu Tam. Tk.



OEM Ref.

01 02 024

Kaliper Sensör Kapağı (Sensörsüz)



OEM Ref.

01 02 025

Kaliper Sensör Kapağı (2 Kablolu)



OEM Ref.

01 02 026

Kaliper Sensör Kapağı (3 Kablolu
MAN)

01 02 027

Kaliper Sensör Kapağı (3 Kablolu
MERCEDES)



OEM Ref.

OEM Ref.

OEM Ref.

OEM Ref.

OEM Ref.

OEM Ref.

OEM Ref.



KNORR SB6 / SB7 Type

01 03 001 Kaliper Perno Tamir Takımı



OEM Ref. K001532

01 03 003 Kaliper Perno Tamir Takımı



OEM Ref. K000375

01 03 044 Kaliper Perno Tamir Takımı



OEM Ref. K0000696 – II3130370066

01 03 051 Kaliper Perno Tamir Takımı



OEM Ref K000365

01 03 048 Kaliper Perno Tamir Takımı



OEM Ref. II39769F0062

01 03 057 Kaliper Perno Tamir Takımı



OEM Ref. K048396K50

01 03 056 Kaliper Perno Tamir Takımı



OEM Ref. K067417K50

01 03 055 Kaliper Perno Tamir Takımı



OEM Ref. K048371K50

01 03 050 Kaliper Perno Tamir Takımı



OEM Ref. K031844K50 – K011117

01 03 048 Kaliper Perno Tamir Takımı



OEM Ref. K001915 – K048389K50

01 03 049 Kaliper Perno Tamir Takımı



OEM Ref. K000687

01 03 053 Kaliper Perno Tamir Takımı



OEM Ref. II328090062

01 01 002 Kaliper Perno Tamir Takımı



OEM Ref. K000935

01 01 001 Kaliper Perno Tamir Takımı



OEM Ref. II369100062 – II339680062 – 000 420 1282

01 03 002 Kaliper Perno Tamir Takımı



OEM Ref. K000132

01 03 045 Kaliper Perno Tamir Takımı



OEM Ref. II358510062

01 03 046 Kaliper Perno Tamir Takımı



OEM Ref. II179320062

01 03 058 Kaliper Perno Tamir Takımı



OEM Ref. II197140062

01 03 054 Kaliper Perno Tamir Takımı



OEM Ref. II197330062

01 03 052 Kaliper Perno Tamir Takımı



OEM Ref. K010813

01 03 007 Kaliper Tamir Takımı



OEM Ref. II328090061

01 01 004 Kaliper Perno Tamir Takımı



OEM Ref. K000697

01 03 006 Kaliper Perno Tamir Takımı



OEM Ref.

01 03 005 Kaliper Perno Tamir Takımı



OEM Ref. 09.801.06.90.0

01 01 003 Kaliper Perno Tamir Takımı



OEM Ref. II368470064

01 03 004 Kaliper Perno Tamir Takımı



OEM Ref. K003800

01 03 059 Perno Tapa Tamir Takımı



OEM Ref. II39769F0063

01 03 019 Kaliper Lastik Takımı



OEM Ref. II197140063

01 03 060 Kaliper Lastik Takımı



OEM Ref. II344730063

01 01 022 Tapa Lastik Tamir Takımı



OEM Ref. K001301

01 01 008 Kaliper Tamir Takımı 74 mm



OEM Ref. II17920065 / II304130065

01 01 009 Kaliper Tamir Takımı 74 mm



OEM Ref. K000944 – K010604

01 03 015 Kaliper Dürbünü



OEM Ref.

01 01 013 Kaliper Ayar Civatası



OEM Ref.

01 03 018 Kaliper Ayar Mekanizması



OEM Ref.

01 03 031 Kaliper Yaylı Mekanizma



OEM Ref.

01 03 061

Kaliper Ayar Mekanizması



OEM Ref.

01 03 043

Kaliper Ayar Mekanizması



OEM Ref.

01 01 012

Kaliper Bilya Takımı



OEM Ref.

01 03 011

Kaliper Tamir Takımı



OEM Ref.

01 03 062

Dürbün Mil Saç Takımı



OEM Ref.

01 03 033

Kaliper Zinciri (29 Bakla)



OEM Ref.

01 03 014

Kaliper Dişlisi



OEM Ref.

01 03 034

Kaliper Mekanizma Ayar Somunu



OEM Ref. Z001548

01 03 063

Kaliper Masura Bilya Yatak Saç TK.



OEM Ref.

01 03 064

Kaliper Masura Bilya Yatağı (0-127 mm)



OEM Ref.

01 03 065

Kaliper Masura Bilya Yatağı (0-113 mm)



OEM Ref.

01 03 066

Kaliper Masura Bilya Yatağı (0-122 mm)



OEM Ref.

01 03 067

Kaliper Masura Bilya Yatağı (0-122 mm)



OEM Ref. C73164

01 03 024

Kaliper Sensör Kapağı (Sensörsüz)



OEM Ref.

01 03 025

Kaliper Sensör Kapağı (2 Kablolu)



OEM Ref.

01 03 027

Kaliper Sensör Kapağı (3 Kablolu MERCEDES)



OEM Ref

01 03 026

Kaliper Sensör Kapağı (3 Kablolu MAN)



OEM Ref.

01 03 068

Kaliper Sensör Kapağı (Sensörsüz)



OEM Ref.

01 03 014

Kaliper Sensör Kapağı (2 Kablolu)



OEM Ref.

01 03 070

Kaliper Sensör Kapağı (3 Kablolu MAN)



OEM Ref.

01 03 072

Kaliper Lastik Takımı



OEM Ref.

01 03 073

Kaliper Lastik Takımı



OEM Ref.

01 03 036

Sensör Kapak Ayar Plastik Takımı



OEM Ref.

01 03 037

Sensör Çubuğu



OEM Ref.

01 03 042

Tapa Tamir Takımı



OEM Ref. K000945 - 38 mm

01 03 043

Kaliper Lastik Takımı



OEM Ref. 35 mm

01 03 074

Kaliper Lastik Takımı



OEM Ref. 35 mm

01 03 075

Tapa Tamir Takımı



OEM Ref 38 mm

01 01 023

Kaliper Balata Tutucu Tamir Takımı

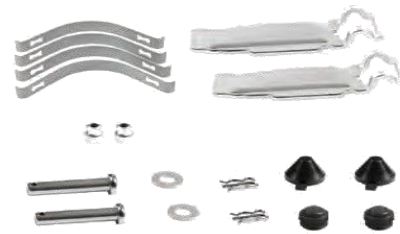

OEM Ref.

01 03 039

Kaliper İpat Tutucu Tamir Takımı



OEM Ref. K000133

01 03 040

Balata Tutucu



OEM Ref.

01 01 020

Kaliper Tapa Takımı



OEM Ref.

01 03 076

Balata Tutucu



OEM Ref.

01 03 077

Balata Tutucu



OEM Ref.

01 01 019

Kaliper Lastik Takımı



OEM Ref.

01 01 021

Tapa Takımı



OEM Ref.



KNORR

**SN6 / SN7 / SK7
NA7 / SF7** Type

www.aseitr.com

01 03 051 Kaliper Perno Tamir Takımı



OEM Ref. K000365

01 04 001 Kaliper Perno Tamir Takımı



OEM Ref. K004100 / K004168 / K010766

01 04 002 Kaliper Perno Tamir Takımı



OEM Ref.

01 04 003 Kaliper Perno Tamir Takımı



OEM Ref

01 04 004 Kaliper Perno Tamir Takımı



OEM Ref. K052759K50

01 03 048 Kaliper Perno Tamir Takımı



OEM Ref. K001915 / K048389K50

01 04 005 Kaliper Perno Tamir Takımı



OEM Ref. K000472 / K017707

01 04 006 Kaliper Perno Tamir Takımı



OEM Ref.

01 0 044 Kaliper Perno Tamir Takımı



OEM Ref. K000698

01 03 006 Kaliper Perno Tamir Takımı



OEM Ref.

01 04 007 Kaliper Tamir Takımı



OEM Ref. K001300 / K010603 / K000366 / K092079

01 04 008 Kaliper Tamir Takımı



01 04 009 Kaliper Tamir Takımı



01 04 015

Kaliper Dürbünü



OEM Ref.

01 04 042

Kaliper Dürbünü



OEM Ref.

01 03 062

Dürbün Mil ve Saç Takımı



OEM Ref.

01 01 013

Kaliper Ayar Civatası



OEM Ref.

01 04 012

Kaliper Bilya Takımı



OEM Ref.

01 01 012

Kaliper Bilya Takımı



OEM Ref.

01 04 018

Kaliper Dişlisi



OEM Ref.

01 03 043

Kaliper Dişlisi



OEM Ref.

01 03 014

Kaliper Dişlisi



OEM Ref.

01 03 033

Kaliper Zinciri (29 Bakla)



OEM Ref.

01 03 031

Kaliper Yaylı Mekanizma



OEM Ref.

01 04 043

Kaliper Yaylı Mekanizma



OEM Ref.

01 03 061

Kaliper Yaylı Mekanizma



OEM Ref.

01 03 034

Kaliper Mekanizma Ayar Somunu



OEM Ref.

01 03 063

Kalipe Masura Bilya Yatak Sağı Takımı

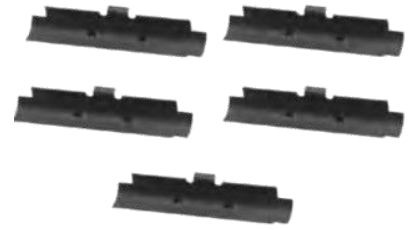

OEM Ref.

01 04 078

Kaliper Masura Bilya Yatağı Açığı (0 - 124 mm)



OEM Ref. Z002965

01 04 065

Kaliper Masura Bilya Yatağı Açığı (0 - 113 mm)



OEM Ref. Z002881

01 04 067

Kaliper Masura Bilya Yatağı Açığı (12 - 122 mm)



OEM Ref. Z002962

01 04 079

Kaliper Masura Bilya Yatağı Açığı (0 - 113 mm)



OEM Ref. Z002881

01 04 066

Kaliper Masura Bilya Yatağı Açığı (12 - 122 mm)



OEM Ref. Z002962

01 04 080

Kaliper Masura Bilya Yatağı Açığı (0 - 124 mm)



OEM Ref.

01 04 017

Kaliper Masura Bilya Yatağı



OEM Ref.

01 03 036

Sensör Kapak Ayar Plastik Takımı



OEM Ref.

01 04 030

Kaliper Saç Kapak Takımı



OEM Ref.

01 03 024

Kaliper Sensör Kapağı
(Sensörsüz)



OEM Ref.

01 03 027

Kaliper Sensör Kapağı
(3 Kablolü Mercedes)



OEM Ref.

01 03 25

Kaliper Sensör Kapağı
(2 Kablolü)



OEM Ref.

01 03 026

Kaliper Sensör Kapağı
(3 Kablolü MAN TGA)



OEM Ref.

01 03 068

Kaliper Sensör Kapağı
(Sensörsüz)



OEM Ref.

01 04 027

Kaliper Sensör Kapağı
(3 Kablolü Mercedes)



OEM Ref.

01 03 069

Kaliper Sensör Kapağı
(2 Kablolü)



OEM Ref.

01 03 070

Kaliper Sensör Kapağı
(3 Kablolü MAN TGA)



OEM Ref.

01 03 072

Kaliper Lastik Takımı



OEM Ref.

01 03 073

Kaliper Lastik Takımı



OEM Ref.

01 03 038

Tapa Tamir Takımı

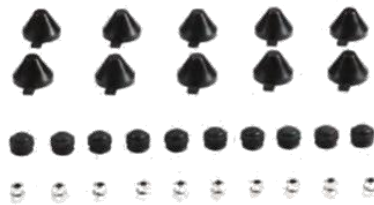

OEM Ref. K000945

01 03 060

Kaliper Lastik Takımı



OEM Ref.

01 03 075

Tapa Tamir Takımı



OEM Ref.

01 03 074

Tapa Lastik Takımı



OEM Ref. K003902

01 01 023

Kaliper Balata Tutucu Tamir TK



OEM Ref.

01 03 039

Kaliper İpat Tutucu Tamir Takımı



OEM Ref. K000133

01 03 076

Balata Tutucu



OEM Ref.

01 03 077

Balata Tutucu



OEM Ref.

01 03 040

Balata Tutucu



OEM Ref.

01 04 019

Kaliper Lastik Takımı



OEM Ref.

01 01 020

Kaliper Tapa Takımı



OEM Ref.

01 01 021

Tapa Takımı



OEM Ref.

01 01 041

Tapa Takımı



OEM Ref.

OEM Ref.



KNORR

SL7 Type

01 03 048

Kaliper Perno Tamir Takımı



OEM Ref. K001915 / K048389K50

01 05 007

Kaliper Tamir Takımı



OEM Ref.

01 05 008

Kaliper Tamir Takımı



OEM Ref.

01 04 042

Kaliper Dürbünü



OEM Ref.

01 05 013

Kaliper Ayar Civatası



OEM Ref.

01 05 018

Kaliper Ayar Mekanizması



OEM Ref.

01 04 018

Kaliper Ayar Mekanizması



OEM Ref.

01 05 043

Kaliper Ayar Mekanizması



OEM Ref.

01 01 020

Frezeli Yaysız Ayar Mekanizması



OEM Ref.

01 04 066

Kaliper Masura Bilya Yatağı Açığı (12 - 122 mm)



OEM Ref.

01 05 012

Kaliper Bilya Takımı



OEM Ref.

01 03 033

Kaliper Zinciri (29 Bakla)



OEM Ref.

01 05 081

Sensör Kapak Ayar Plastik Takımı
8.4 mm



OEM Ref.

01 05 082

Sensör Kapak Ayar Plastik
Takımı 9,8 mm



OEM Ref.

01 03 027

Kaliper Sensör Kapağı (3
Kablolu MERCEDES)



OEM Ref.

01 05 047

Kaliper Kapağı



OEM Ref.

OEM Ref.

OEM Ref.



KNORR

SM7 Type

01 03 048

Kaliper Perno Tamir Takımı



OEM Ref. K001915 / K048389K50

01 03 006

Kaliper Perno Tamir Takımı



OEM Ref.

01 06 001

Kaliper Tamir Takımı



OEM Ref. K012912

01 06 007

Kaliper Tamir Takımı 69 mm



OEM Ref.

01 06 008

Kaliper Tamir Takımı 69 mm



OEM Ref. K046523K50

01 04 042

Kaliper Dürbünü



OEM Ref.

01 06 012

Kaliper Ayar Civatası



OEM Ref.

01 03 043

Kaliper Ayar Mekanizması



OEM Ref.

01 03 061

Kaliper Ayar Mekanizması



OEM Ref.

01 05 081

Frezeli Yaysız Ayar Mekanizması



OEM Ref.

01 06 066

Kaliper Masura Bilya Yatağı Açığı (122 mm)



OEM Ref. Z033222

01 05 082

Sensör Kapak Ayar Plastik Takımı



OEM Ref.

01 04 030 Kaliper Saç Kapak Takımı



OEM Ref.

01 03 024 Kaliper Sensör Kapağı (Sensörsüz)



OEM Ref.

01 03 025 Kaliper Sensör Kapağı (2 Kablolu)



OEM Ref.

01 03 027 Kaliper Sensör Kapağı (3 Kablolu Mercedes)



OEM Ref.

01 03 026 Kaliper Sensör Kapağı (3 Kablolu MAN TGA)



OEM Ref.

01 03 038 Tapa Tamir Takımı



OEM Ref.

01 03 075 Tapa Tamir Takımı

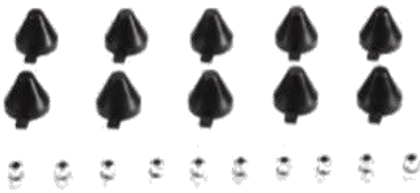

OEM Ref.

01 06 023 Kaliper Balata Tutucu Tamir Takımı



OEM Ref. II19712004 / II30679004 / II197120061 / K000129

01 03 077 Kaliper Balata Tutucu Tamir Takımı



OEM Ref.

01 03 072 Kaliper Lastik Takımı



OEM Ref.

01 01 041 Tapa Takımı



OEM Ref.

01 01 020 Kaliper Tapa Takımı



OEM Ref.



KNORR

SB7 Type

01 03 051 Kaliper Perno Tamir Takımı



OEM Ref. K001532

01 03 048 Kaliper Perno Tamir Takımı



OEM Ref. I139769F0062

01 03 003 Kaliper Perno Tamir Takımı



OEM Ref. K000375

01 03 044 Kaliper Perno Tamir Takımı



OEM Ref. K000696 / I1310370066

01 03 050 Kaliper Perno Tamir Takımı



OEM Ref. K031844K50 / K011117

01 03 051 Kaliper Perno Tamir Takımı



OEM Ref. K000365

01 03 052 Kaliper Perno Tamir Takımı



OEM Ref. K010813

01 03 055 Kaliper Perno Tamir Takımı



OEM Ref. K048371K50

01 03 056 Kaliper Perno Tamir Takımı



OEM Ref. K067417K50

01 03 006 Kaliper Perno Tamir Takımı



OEM Ref. K000687

01 03 048 Kaliper Perno Tamir Takımı



OEM Ref. K001915 / K048389K50

01 01 001 Kaliper Perno Tamir Takımı



OEM Ref. I1369100062 / I1339680062 / 000 420 1282

01 01 002 Kaliper Perno Tamir Takımı



OEM Ref. K000935

01 03 002 Kaliper Perno Tamir Takımı



OEM Ref. K000132

01 03 053 Kaliper Perno Tamir Takımı



OEM Ref. I1328090062

01 03 044 Kaliper Perno Tamir Takımı



OEM Ref. I1179320062

01 03 045 Kaliper Perno Tamir Takımı



OEM Ref. I1358510062

01 03 054 Kaliper Perno Tamir Takımı



OEM Ref. I197330062

01 03 005 Kaliper Perno Tamir Takımı



OEM Ref. 09.801.06.90.0

01 01 004 Kaliper Perno Tamir Takımı



OEM Ref. K000697

01 03 056 Kaliper Perno Tamir Takımı



OEM Ref. I1368470064

01 03 004 Kaliper Perno Tamir Takımı



OEM Ref. K003800

01 03 007 Kaliper Tamir Takımı



OEM Ref. I1328090061

01 01 022 Tapa Lastik Tamir Takımı



OEM Ref. K001301

01 03 006 Kaliper Perno Tamir Takımı



OEM Ref.

01 03 059 Perno Tapa Tamir Takımı



OEM Ref. II39769F0063

01 01 008 Kaliper Tamir Takımı 74 mm



OEM Ref. II179320065 / II304130065

01 01 009 Kaliper Tamir Takımı 74 mm



OEM Ref. K000944 / K010604

01 03 015 Kaliper Dürbünü



OEM Ref.

01 01 013 Kaliper Perno Tamir Takımı



OEM Ref.

01 03 043 Kaliper Ayar Mekanizması



OEM Ref.

01 01 031 Kaliper Yaylı Mekanizma



OEM Ref.

01 04 018 Kaliper Ayar Mekanizması



OEM Ref. II368470064

01 01 023 Kaliper Lastik Takımı

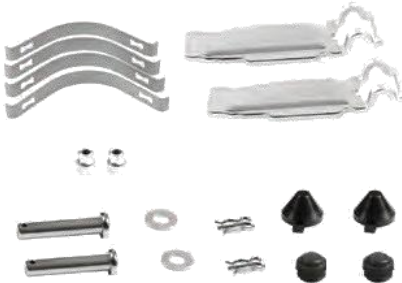

OEM Ref.

01 03 014 Balata Tutucu



OEM Ref.

01 01 021 Tapa Takımı



OEM Ref.

01 06 017

Kaliper Ayar Mekanizması



OEM Ref. K100259 / K000250

01 06 084

Kaliper Ayar Mekanizması



OEM Ref.

01 01 012

Kaliper Bilya Takımı



OEM Ref.

01 03 011

Kaliper Tamir Takımı



OEM Ref

01 03 063

Kalipe Masura Bilya Yatak Sağı Takımı



OEM Ref.

01 03 033

Kaliper Zinciri (29 Bakla)



OEM Ref.

01 01 019

Kaliper Lastik Takımı



OEM Ref.

01 03 014

Kaliper Dişlisi



OEM Ref.

01 03 063

Kaliper Mekanizma Somunu



OEM Ref. Z001548

01 06 069

Kaliper Sensör Kapağı (2 Kablolu)



OEM Ref.

01 06 071

Kaliper Sensör Kapağı (3 Kablolu Mercedes)



OEM Ref.

01 06 070

Kaliper Sensör Kapağı (3 Kablolu Man TGA)



OEM Ref.

01 06 088 Kaliper Sensör Kapağı
(Sensörsüz) TK.



OEM Ref.

01 06 085 Kaliper Sensör Kapağı Tk.
(2 Kablolu)



OEM Ref.

01 06 086 Kaliper Sensör Kapağı
(3 Kablolu Mercedes)



OEM Ref.

01 06 087 Kaliper Sensör Kapağı
(3 Kablolu Man TGA)



OEM Ref

01 06 023 Kaliper Balata Tutucu Tamir
Takımı



OEM Ref. II19712004 / II30679004 / II197120061 / K000129

01 06 068 Kaliper Sensör Kapağı
(Sensörsüz)



OEM Ref.

01 01 041 Tapa Takımı



OEM Ref.

OEM Ref.

OEM Ref.

OEM Ref.

OEM Ref.

OEM Ref.



BENDIX

www.aseitr.com

01 07 089

Tutucu Civata Takımı



OEM Ref. I133692

01 07 001

Kaliper Perno Tamir Takımı



OEM Ref. 381.413

01 07 002

Kaliper Perno Tamir Takımı



OEM Ref. 381.391



OEM Ref.



OEM Ref.



OEM Ref.



OEM Ref.



OEM Ref.



OEM Ref.



OEM Ref.



OEM Ref.



OEM Ref.



KIZAKLAR

www.aseitr.com

01 09 090 Kaliper Kızak 22.5



OEM Ref. SB7 / SN7

01 09 091 Kaliper Kızak 22.5



OEM Ref. SB7 / SN7

01 09 092 Kaliper Kızak 22.5



OEM Ref. K001528

01 09 093 Kaliper Kızak 22.5



OEM Ref. K000027

01 09 094 Kaliper Kızak 22.5



OEM Ref. K000026

01 09 098 Kaliper Kızak 19.5



OEM Ref. Z019053

01 09 095 Kaliper Kızak 22.5



OEM Ref. K052379K50

01 09 106 Kaliper Kızak 17.5



OEM Ref. K001927

01 09 099 Kaliper Kızak 19,5



OEM Ref. Z017557

01 09 097 Kaliper Kızak 22.5 L



OEM Ref. K012619

01 09 096 Kaliper Kızak 22.5



OEM Ref. K001278

01 09 111 Kaliper Kızak 22.5 L



OEM Ref. K001529

01 09 112 Kaliper Kızak 22.5 R



OEM Ref. K001530

01 09 102 Kaliper Kızak 19.5



OEM Ref.

01 09 103 Kaliper Kızak 19.5



OEM Ref. SN6

01 09 113 Kaliper Kızak 22.5



OEM Ref. K010765

01 09 115 Kaliper Kızak 22.5



OEM Ref. K015308 / Z019050

01 09 116 Kaliper Kızak 19.5

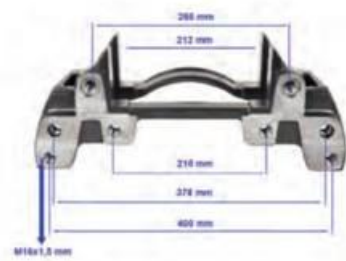

OEM Ref.

01 09 117 Kaliper Kızak 22.5



OEM Ref. SN7

01 09 118 Kaliper Kızak 22.5



OEM Ref. Z046338

01 09 099 Kaliper Kızak 22,5



OEM Ref. K046498K50 / 000 421 570 6

OEM Ref.

OEM Ref.

OEM Ref.

OEM Ref.

OEM Ref.

OEM Ref.

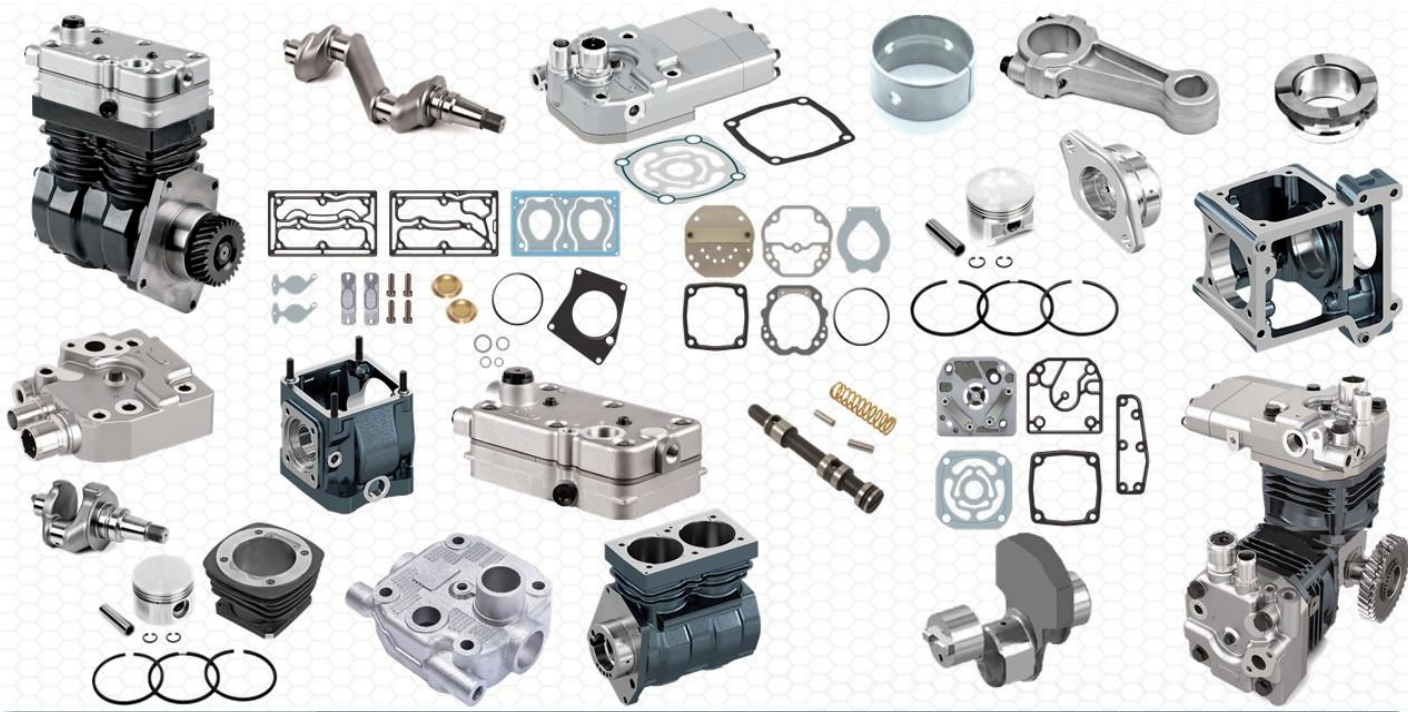

Web : www.aseletr.com

Air Brake Compressor
E-mail : info@aseletr.com

Gücünüze güç, işinize değer katar..

Adds power your strength, adds value to your business...

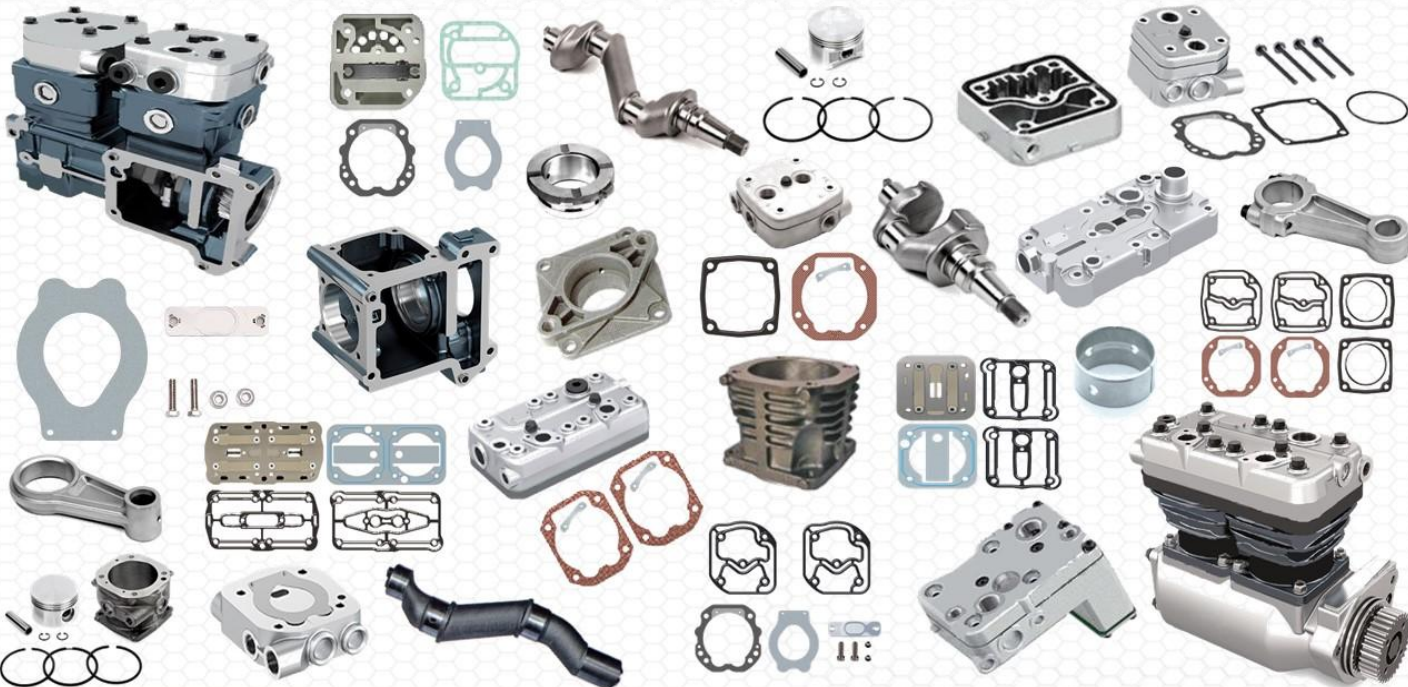

Web : www.aseletr.com

Air Brake Compressor
E-mail : info@aseletr.com

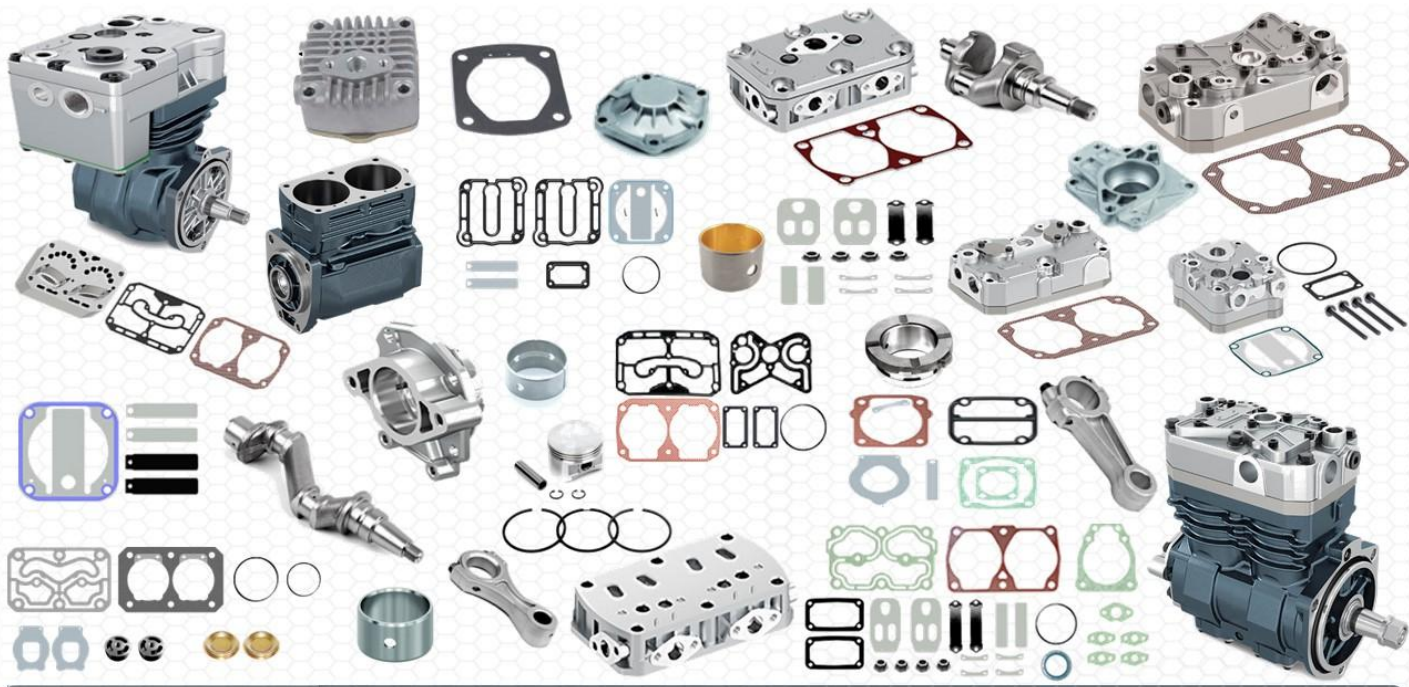

Web : www.aseeltr.com

Air Brake Compressor
E-mail : info@aseeltr.com

Gücünüze güç, işinize değer katar..

Adds power your strength, adds value to your business...

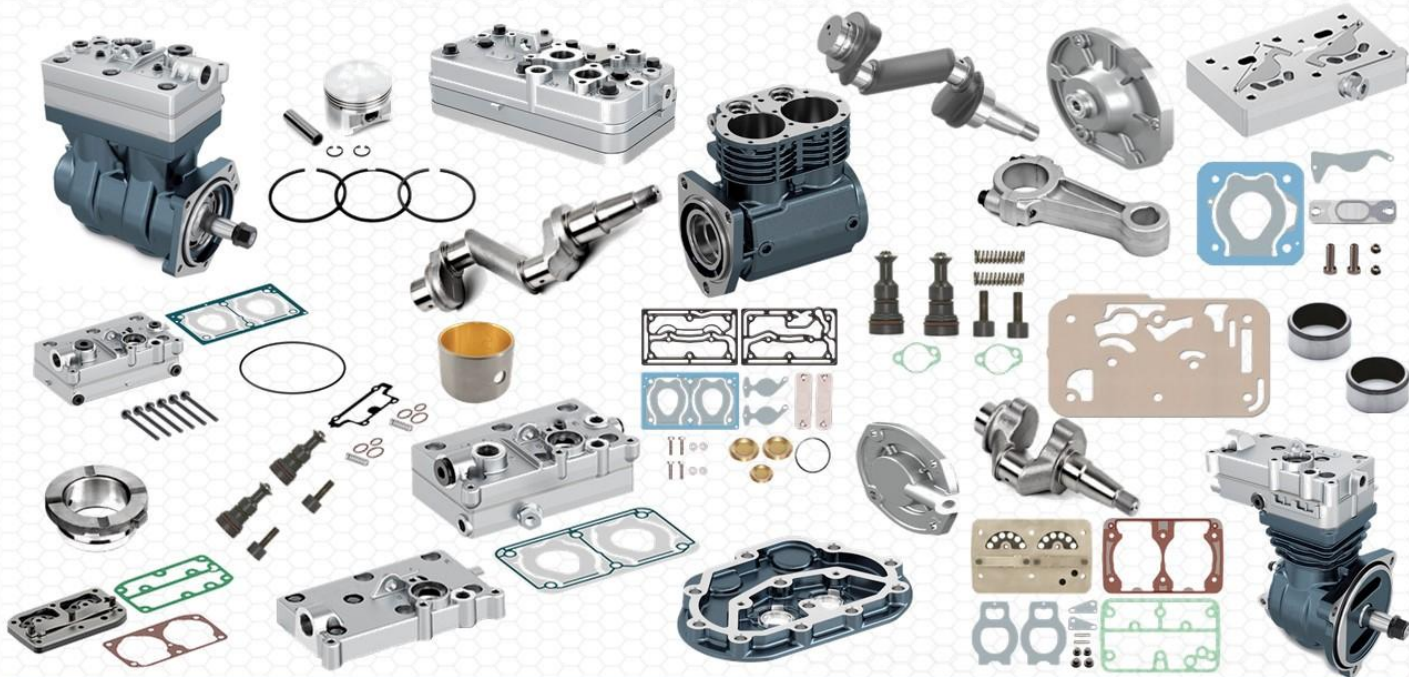

Web : www.aseeltr.com

Air Brake Compressor
E-mail : info@aseeltr.com



Web: www.aseeltr.com

Air Brake Compressor
E-mail: info@aseeltr.com

Gücünüze güç, işinize değer katar..

Adds power your strength, adds value to your business...



Web: www.aseeltr.com

Air Brake Compressor
E-mail: info@aseeltr.com



Web : www.aseltr.com

Gasket Components
E-mail : info@aseltr.com

Gücünüze güç, işinize değer katar..

Adds power your strength, adds value to your business...



Web : www.aseltr.com

Air Disc Brake Caliper
E-mail : info@aseltr.com



Power in Your Brakes

İletişim Bilgileri

ASEL TAŞKAN OTOMOTİV SANAYİ ve TİC. LTD. ŞTİ

Dudullu Organize Sanayi Bölgesi

3.Cadde No : 5 / 78 Ümraniye / İSTANBUL

+90 216 313 83 23

info@aseltr.com

+90 532 440 59 23

www.aseltr.com

[aselairbrakesystems](https://www.instagram.com/aselairbrakesystems)

[facebook.com/asel](https://www.facebook.com/asel)