

High Quality Air Brake Components

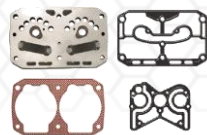

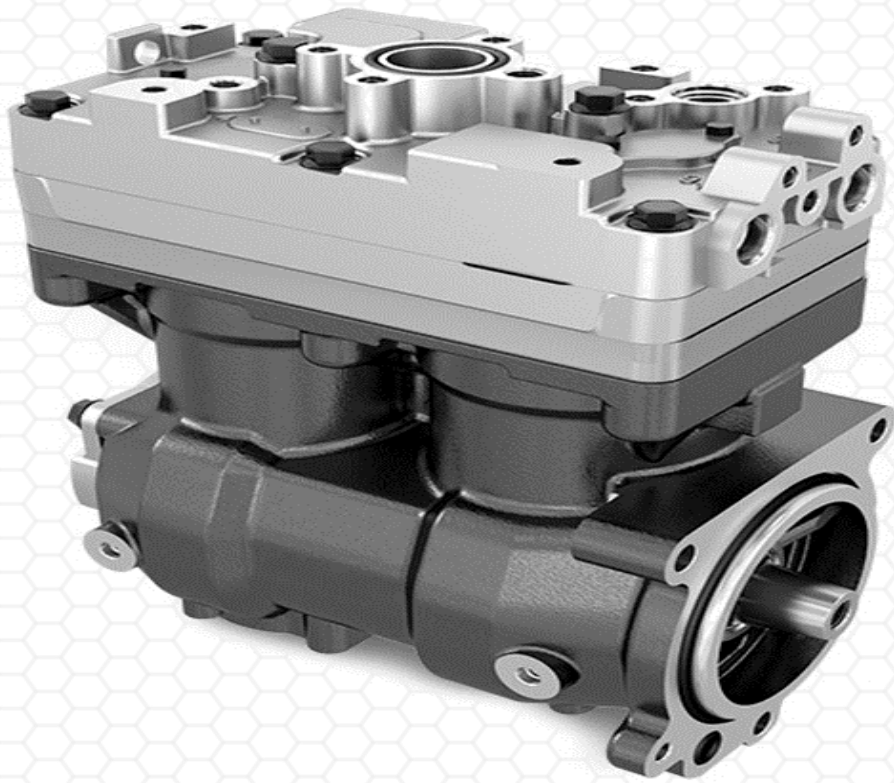

High Quality Air Brake Components



AIR BRAKE COMPRESSOR & REPAIR KIT

MERCEDES

MAN

FORD

BMC

VOLVO

DAF

SCANIA

RENAULT

IVECO

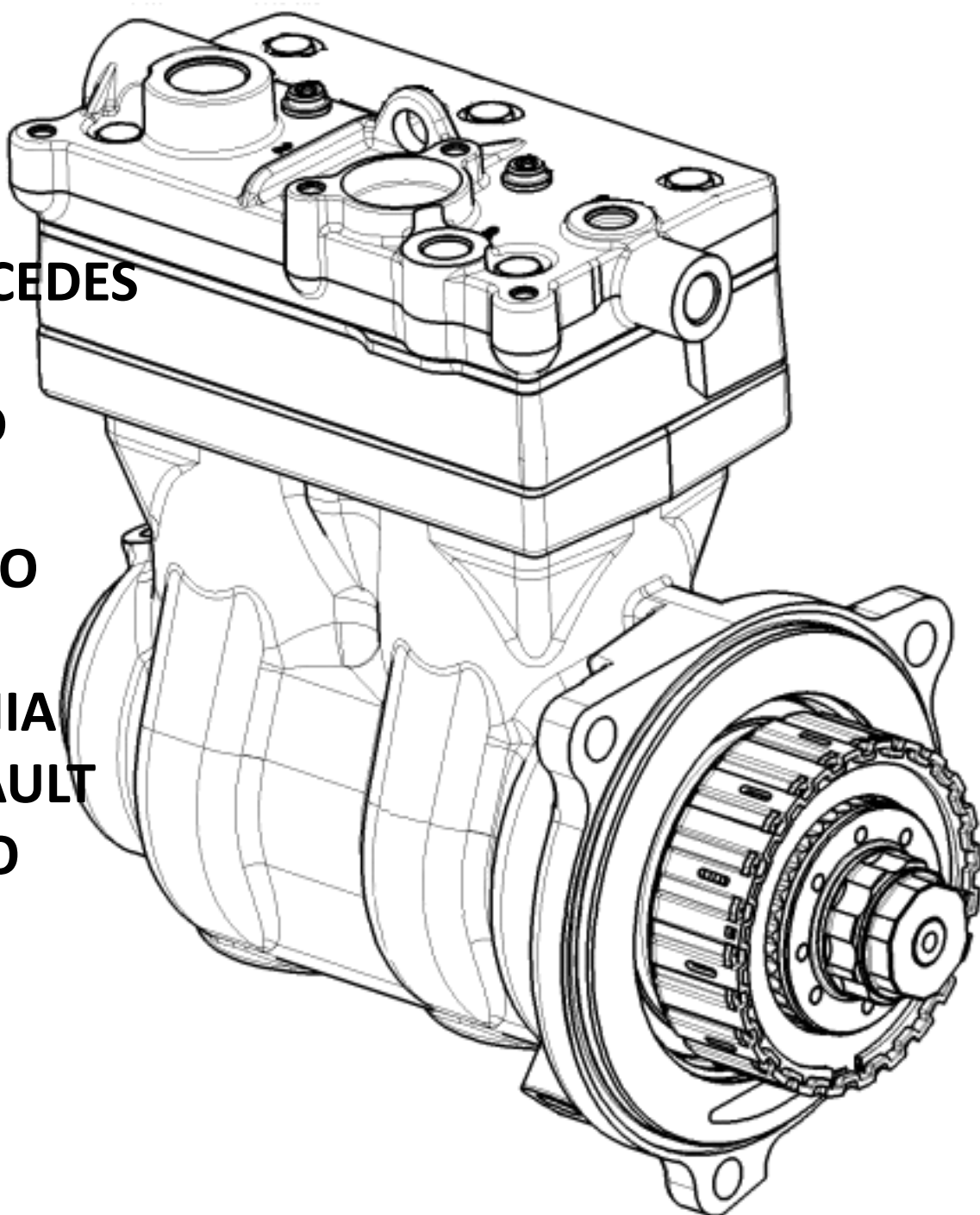

asel[®]

AIR BRAKE SYSTEMS

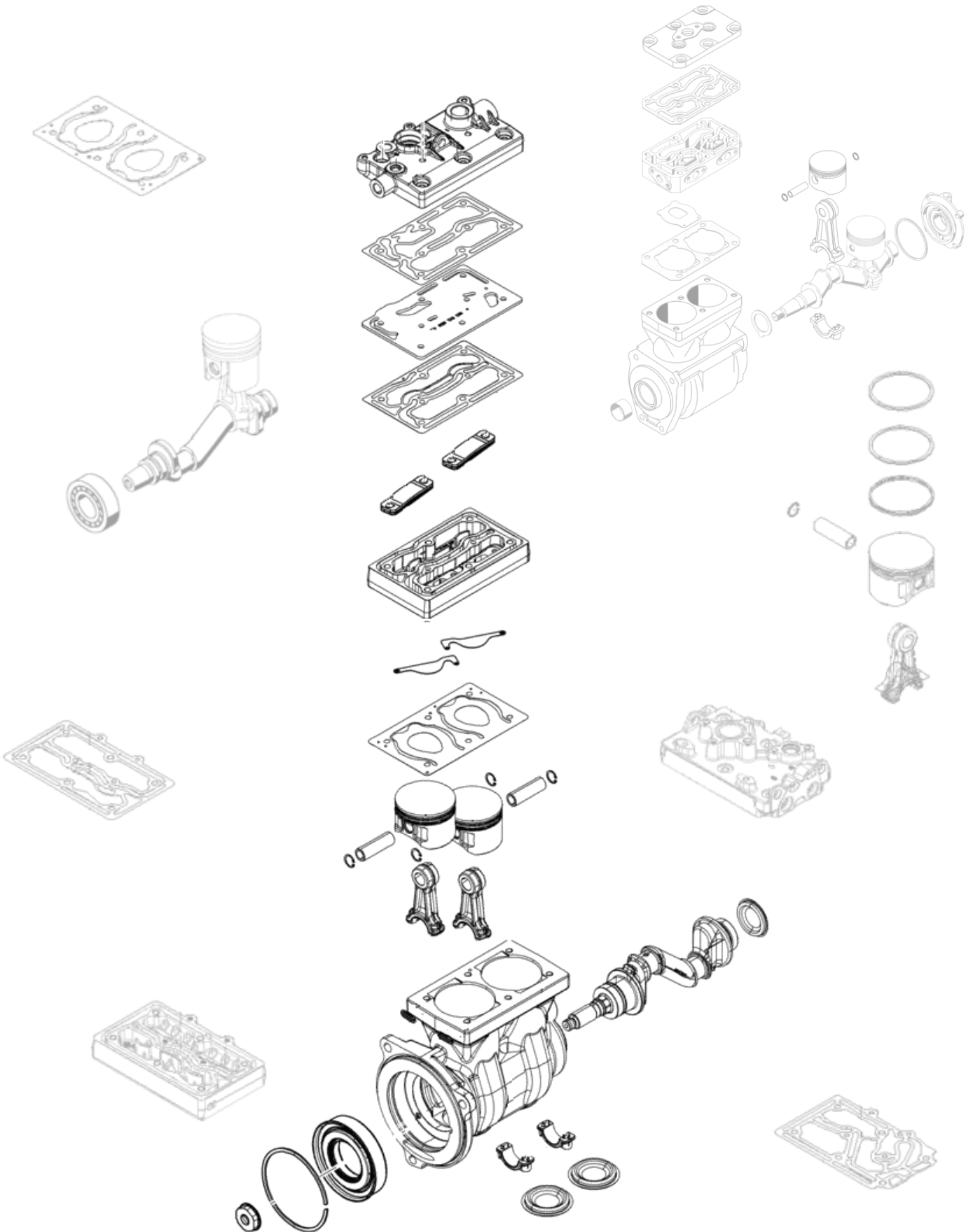

Sertifikalar / Certificates / شهادة



HAKKIMIZDA

Asel Air Brake Systems 2012 yılında İstanbul'da yük ve yolcu taşımacılığında kullanılan ticari araçların fren aksamalarında ki havalı fren sistemine ait parçaların üretimini yapmak için kurulmuştur.

Kısa zaman içerisinde kalitesi ve uygun fiyat politikasıyla adından söz ettirerek yurt içi ve yurt dışı pazarında yer almıştır.

Asel yük ve yolcu taşımacılığında kullanılan araçların havalı fren kompresörlerini ve yedek parçaları olan; silindir kapak, pleyt , kompresör gövdesi , krank mili, piston kolu , piston segmanı , piston , dişli , burç , valf takımı , tamir takımı ve conta takımı üretimlerini yaparak 4 kıtada 35 den fazla ülkeye ihraç etmektedir.

Firmamız otomotiv sektöründe önemli bir rolü olan TS EN ISO 9001:2008 ile TSE ISO EN 9000 kalite uygunluk ve yönetim belgelerine sahiptir.

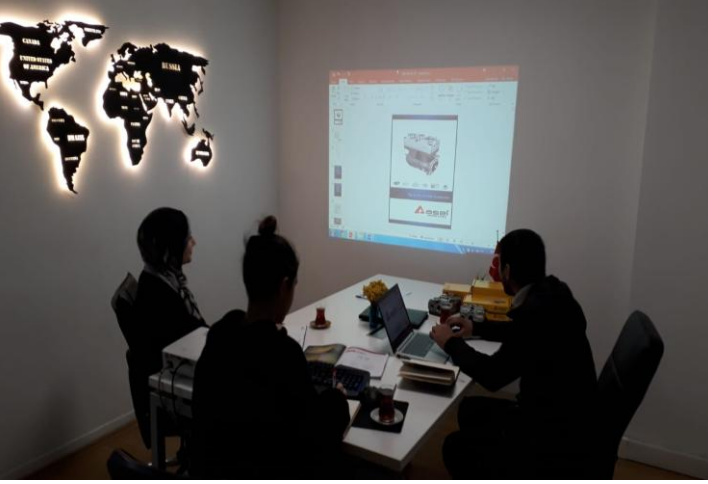

VİZYONUMUZ

Sürekli gelişme ve iyileştirme ilkesi doğrultusunda; Küresel pazarın talepleri doğrultusunda değerler ile sürdürülebilir büyümesini koruyan

Yurt içi ve yurt dışı OEM ile after market satışlarında müşteri memnuniyeti odaklı çalışma prensibiyle istikrarlı bir şekilde büyümeye devam etmeyi amaçlamaktadır. satış ve satış sonrası hizmet ağıyla kaliteli , rekabet gücü yüksek , güvenilir , çevre ve insana duyarlı olarak otomotiv yedek parça pazarında Türk Otomotiv Sanayisinde en değerli ve en çok tercih edilen başarılı bir sanayi şirketi olmak



MİSYONUMUZ

Basınçlı hava sistemleri alanında Türk sanayii başta olmak üzere yurt içi ve yurt dışındaki müşterilerine katma değeri yüksek, yenilikçi , güvenilir ürün ve çözümleri sunarak küresel hedeflerine marka bilinirliğini artırarak kurumsallaşma, en iyi istihdam personel ve ekipmanlara yatırım yaparak ürünlerimizi kullanan herkesin yüksek performans ve kalite beklentisini karşılamak bilinciyle çalışmakta ve bu bilinci tüm ekip arkadaşlarımız ve siz değerli müşterilerimiz ile paylaşmaktayız.

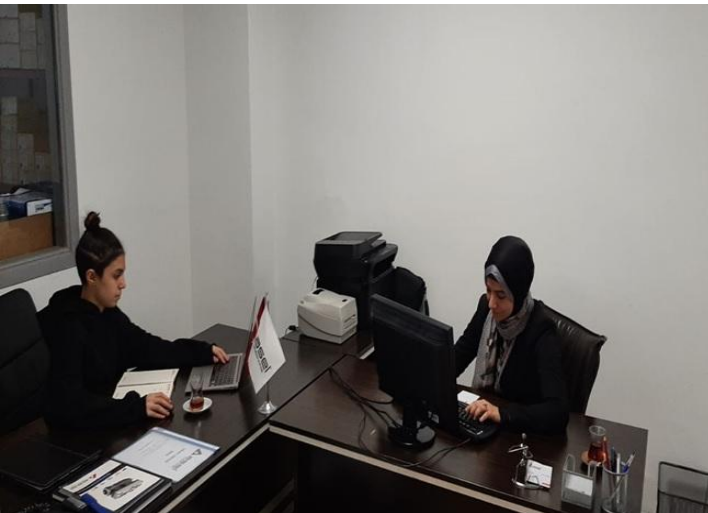

DEĞERLERİMİZ

Başarımız, temel değerlere dayanır:

- İnsana ve çevreye saygılı,
- Takım Ruhu ve Bütünlük.
- Toplam kalite prensiplerini benimsemiş
- Güvenilir , Dürüst,
- Önce Müşteri ve Bireye Saygı
- Çözüm odaklı
- Sürekli daha iyi olmanın gerekliliğine inanarak kendini geliştirmeyi amaç edinmiş
- Müşteri memnuniyetinin para kazanmaktan daha önemli olduğunu bilen bir firmayız.

ABOUT US

Asel Air Brake Systems was established in 2012 in Istanbul to produce parts of the air brake system in the brake components of commercial vehicles used in freight and passenger transportation

In a short time, it made a name for itself with its quality and reasonable price policy and took its place in the domestic and international markets

Asel air brake compressors and spare parts of vehicles used in freight and passenger transportation produces; cylinder head, plate, compressor body, crankshaft, piston rod, piston ring, piston, gear, bushing, valve set, repair kit and gasket kit and exports them to more than 35 countries in 4 continents

Our company has TS EN ISO 9001:2008 and TSE ISO EN 9000 quality conformity and management certificates, which have an important role in the automotive industry.

VISION

In line with the principle of continuous development and improvement;

Maintaining its sustainable growth with values in line with the demands of the global market

With domestic and international OEM aims to continue to grow steadily with the principle of working with a focus on customer satisfaction in after-market sales.

To be the most valuable and most preferred successful industrial company in the Turkish Automotive Industry in the automotive spare parts market, with its sales and after-sales service network, by being high quality, competitive, reliable, sensitive to the environment and people



MISSION

In the field of compressed air systems, by offering high value-added, innovative, reliable products and solutions to domestic and foreign customers, especially the Turkish industry, institutionalization by increasing brand awareness for its global goals, best employment personnel and we work with the awareness of meeting the high performance and quality expectations of everyone who uses our products by investing in equipment, and we share this awareness with all our teammates and our valued customers.



OUR VALUES

Our success is based on core values:

- Respectful to people and the environment.
- Team Spirit and Integrity.
- It has adopted the principles of total quality.
- Reliable and Honest.
- Respect for Customer and Individual First.
- Solution oriented.
- Believing in the necessity of being better all the time, it aimed to improve itself.
- Knowing that customer satisfaction is more important than making money we are a company.



Montaj / Assambely

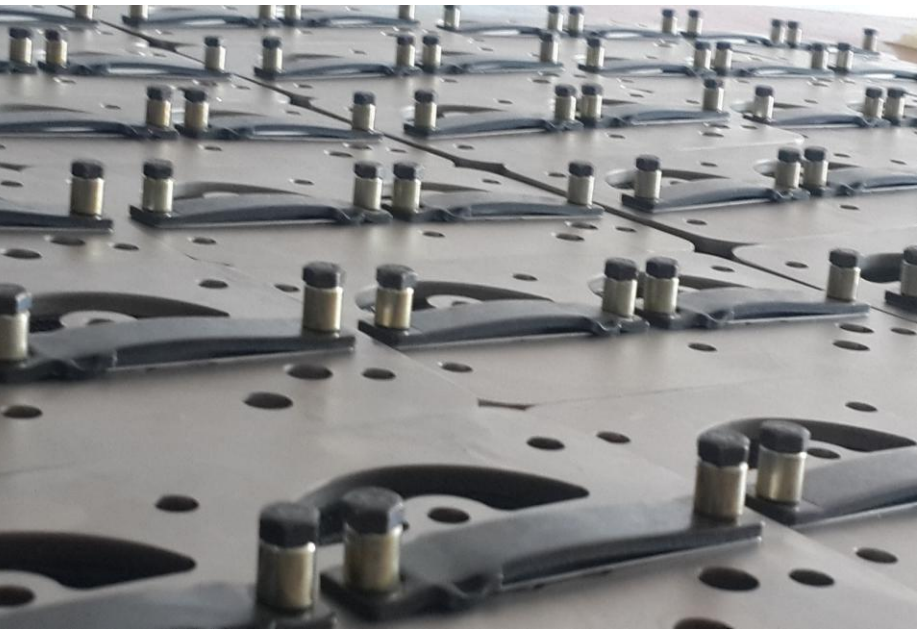

Paketleme / Packaging







Ürün Kod Açıklaması / Product Code Description

ASEL CODE

101.100

1 01 . 1XX

Markalar / Brands

- 1 - MERCEDES
- 2 - MAN
- 3 - FORD / BMC
- 4 - VOLVO
- 5 - DAF
- 6 - SCANIA
- 7 - RENAULT
- 8 - IVECO

Kullanılan Araç Vehicle Application

AXOR, TGA, PRO 822, etc.

Detaylar için sonraki
sayfaya bakınız.

For details see next page

Ürün Grubu / Product Group

- 1 - Komple Kompresör / Compressor Complete
- 2 - Silindir Kapak / Cylinder Head – Pleyt / Plate
- 3 - Tamir Takımı / Repair Kit
- 4 - Valf Takımı / Valve Kit
- 5 - Piston / Piston
- 6 - Segman / Ring
- 7 - Silindir Gömlek / Cylinder Liner
- 8 - Krank Mili / Crankshaft – Dişli / Gear

MERCEDES

01 - 62

MAN

63 - 130

FORD

131 - 141

BMC

142 - 157

VOLVO

158 - 217

DAF

218 - 241

SCANIA

242 - 263

RENAULT

264 - 285

IVECO

286 - 307

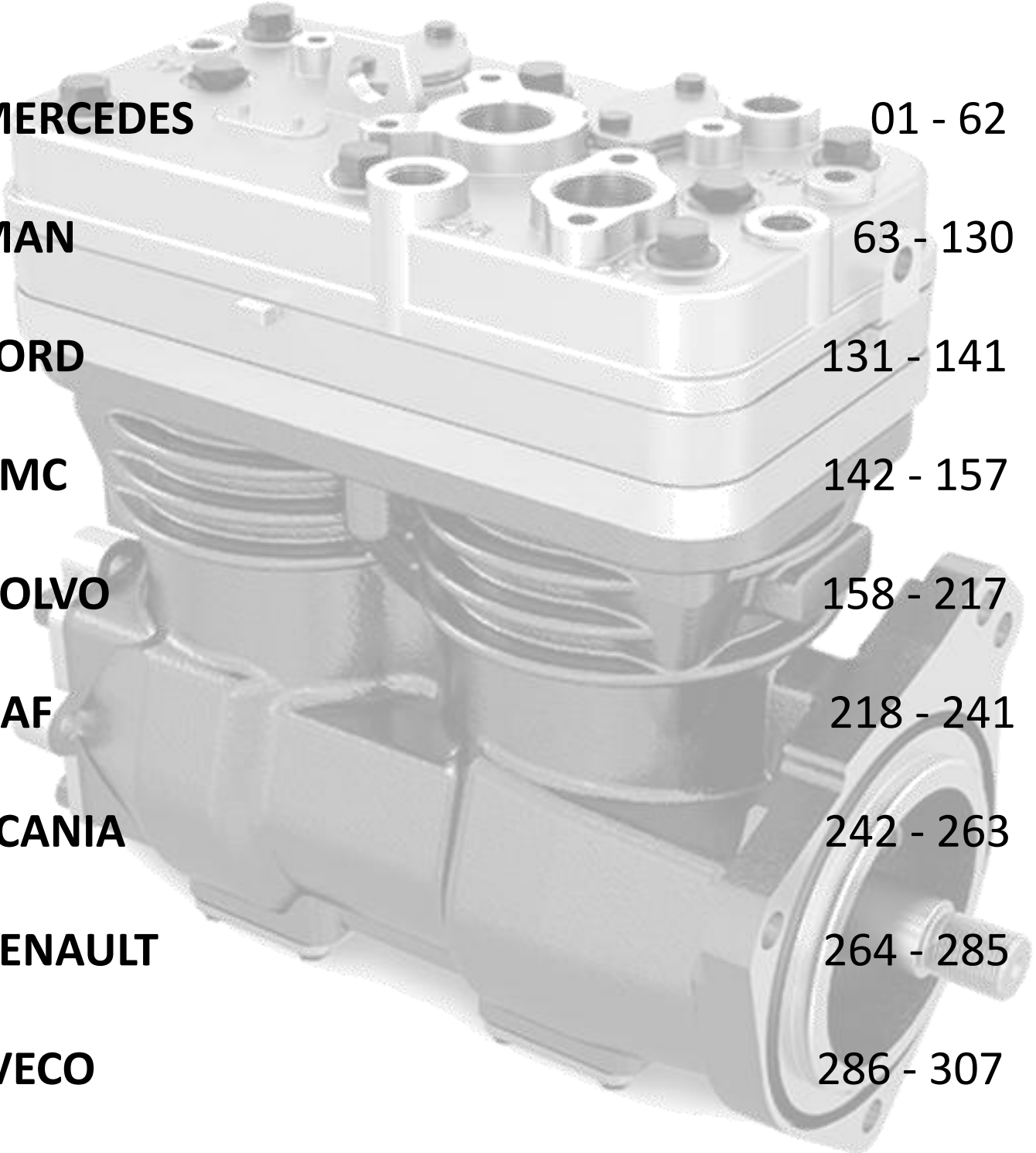



Mercedes-Benz

KOMPRESOR YEDEK PARÇALARI
COMPRESSOR SPARE PARTS

www.aseltr.com

İÇİNDEKİLER / INDEX

Sayfa No / Page No

MERCEDES

AXOR / NATO / OM457	01-02
AXOR / TRAVEGO	03-04
AXOR / ATEGO	05-06
AXOR / ATEGO / EURO 4	07-08
AXOR / OM457	09-10
OM 501 / OM 502 / V6N / V8N / ACTROS	11-12
OM 355 / OM 356	13-14
OM 355 / OM 362 / OM 364 / OM 366	15-16
OM 447 / EURO 1	17-18
OM 355 OM 362 OM 366 LA SERIES	19-20
MB 407	21-22
MB 407 / OM 447 / EURO 1	23-24
EURO 2 / BUS	25-26
OM 407 SERIES	27-28
OM 405 / OM 407 / OM 457	29-30
MB 407	31-32
OM 501 / OM 502 / V6	33-34
ACTROS / OM 501 / OM 502 / V TYPE / EURO 4 / EURO 5	35-36
AXOR 1840 – 3240 / ATEGO	37
AXOR / OM 904 / OM 906 / OM 924 / LA SERIES	38
OM 501 / OM 502 / EURO 4 / EURO 5 / V TYPE	39-40
AXOR / OM 457	41-42
ATEGO / OM 904 LA / OM 906 LA / OM 924 LA	43-44
AXOR / TOURINO / CITARO / INTOURO / OM 906 LA / OM 906 HLA / OM 926 LA	45-46
AROCS / EURO 6 / OM 471 / OM 473 LA	47-48
MB 407	49-50
OM 447 / D015	51-52
AXOR / OM 457 / EURO 5 /	53-54
OM 470 SERIES / EURO 6 SERIES / TRAVEGO SERIES / TOURISMO SERIES	55-56
ACTROS EURO 6 / OM471 LA / OM473 LA	57-58
EVOBUS / CITARO SERIES	59-60
EVOBUS / CITARO / O 530G / O 530L / AXOR	61-62

ASEL CODE

101.100

OEM Reference

412 352 026 0 / 412 352 027 0 / 412 352 031 0 / 457 130 45 15 / 457 130 26 15 / 457 130 67 15
457 130 68 15 / 476 130 01 15

**Kullanılan Araç
Vehicle Application**

AXOR / NATO / OM457



Technical Data

Cylinder Bore	Ø 85.00 mm
Swept Volume	352 cc
Stroke	62 mm

101.200

Complete Cylinder Head



OEM Ref. 001 130 12 15 / 001 130 52 19
412 352 922 2

101.210

Cylinder Head



OEM Ref 000 998 27 90
412 352 659 4

101.250

Plate

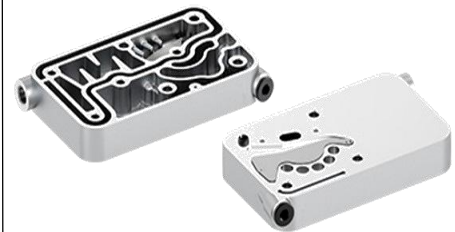

OEM Ref. 000 130 50 19
412 352 658 2

101.270

Cooling Plate

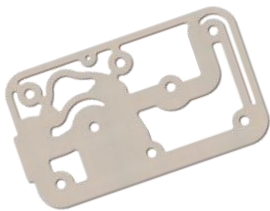

OEM Ref. 000 130 99 20
412 352 101 4

101.300

Full Repair Kit

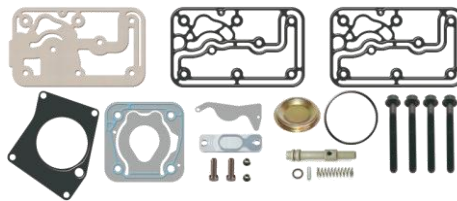

OEM Ref.

101.310

Repair Kit

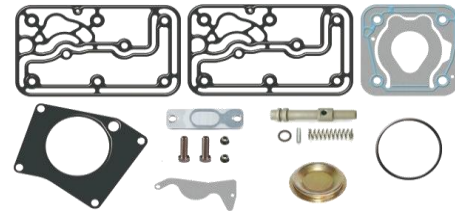

OEM Ref.

101.320 **Repair Kit**

OEM Ref.

101.350 **Gasket Kit**

OEM Ref.

101.360 **Gasket**

OEM Ref. 457 131 01 80

101.400 **Valve Kit**

OEM Ref.

101.410 **Valve Kit**

OEM Ref.

101.150 **Crankcase**

OEM Ref. 412 905 011 2

101.500 **Ø 85,00 mm** **Piston**

101.510 **Ø 85,25 mm**

101.520 **Ø 85,50 mm**

OEM Ref.

101.550 **Ø 85,00 mm** **Piston & Ring**

101.560 **Ø 85,25 mm**

101.570 **Ø 85,50 mm**

OEM Ref. 000 130 34 17 / 000 130 53 17
911 501 624 2 / 911 501 625 2

101.600 **Ø 85,00 mm** **Ring**

101.610 **Ø 85,25 mm**

101.620 **Ø 85,50 mm**

OEM Ref. 001 131 11 11
911 501 920 2

101.450 **Connecting Rod**

OEM Ref. 000 131 25 17
000 131 29 17 / 911 145 738 2
912 000 730 2 / 51.54106-6023

101.750 **Bushing**

OEM Ref. 911 553 204 4

101.800 **Crankshaft**

OEM Ref. 412 905 690 4

101.820 **Gear**

OEM Ref. 457 132 09 05
895 905 188 4

101.830 **Crankshaft Flange**

OEM Ref. 000 131 29 32
411 147 603 4

ASEL CODE

102.100

OEM Reference

457 130 36 15 / 457 130 48 15 / 457 130 49 15 / 912 510 100 0 / 912 510 101 0 / 912 510 102 0
912 510 103 0 / 912 510 104 0

**Kullanılan Araç
Vehicle Application**

AXOR / TRAVEGO

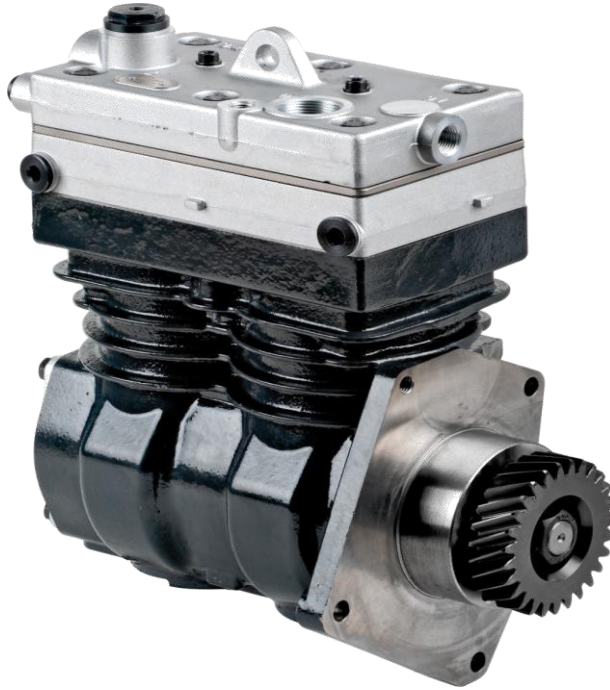

Technical Data

Cylinder Bore	Ø 85.00 mm
Swept Volume	636 cc
Stroke	56 mm

102.200

Complete Cylinder Head

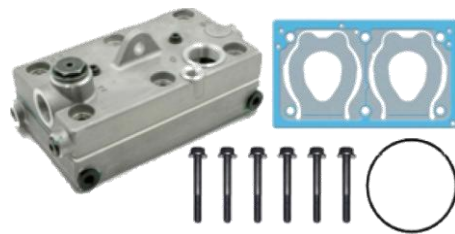

OEM Ref. 001 130 47 15 / 001 130 59 15
912 510 920 2

102.210

Cylinder Head



OEM Ref.

102.250

Plate



OEM Ref.

102.270

Cooling Plate



OEM Ref.

102.300

Full Repair Kit

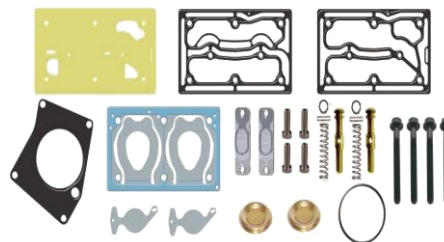

OEM Ref.

102.310

Repair Kit

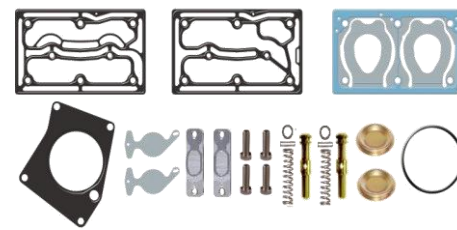

OEM Ref.

102.320 Repair Kit

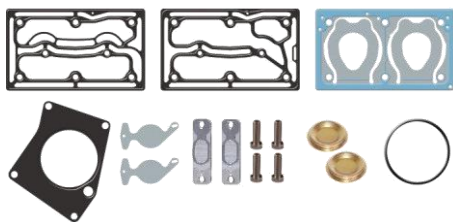

OEM Ref.

102.330 Repair Kit

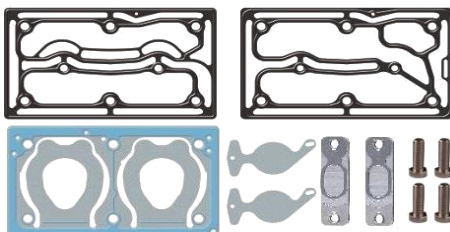

OEM Ref. 002 130 06 15
912 510 929 2

102.350 Gasket Kit

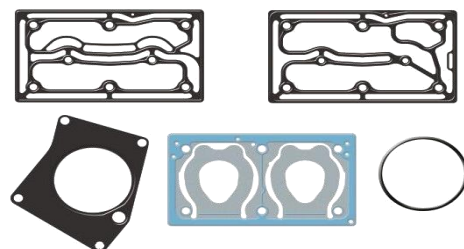

OEM Ref. 912 510 921 2

102.400 Valve Kit

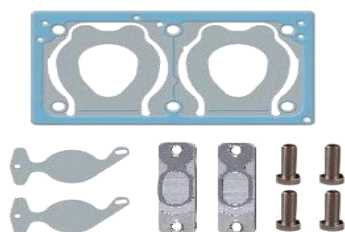

OEM Ref. 912 518 923 2

102.410 Valve Kit



OEM Ref.

102.150 Crankcase



OEM Ref. 912 510 017 2

101.500 Ø 85,00 mm Piston



OEM Ref.

101.550 Ø 85,00 mm Piston & Ring



OEM Ref. 000 130 34 17 / 000 130 53 17
911 501 624 2 / 911 501 625 2

101.510 Ø 85,25 mm

101.560 Ø 85,25 mm

101.520 Ø 85,50 mm

101.570 Ø 85,50 mm

101.600 Ø 85,00 mm Ring



OEM Ref. 001 131 11 11
911 501 920 2

101.610 Ø 85,25 mm

101.620 Ø 85,50 mm

101.450 Connecting Rod



OEM Ref. 000 131 25 17
000 131 29 17 / 911 145 738 2
912 000 730 2 / 51.54106-6023

101.750 Bushing



OEM Ref. 911 553 204 4

102.800 Crankshaft



OEM Ref. 911 553 694 4

101.820 Gear



OEM Ref. 457 132 09 05
895 905 188 4

101.830 Crankshaft Flange



OEM Ref. 000 131 29 32
411 147 603 4

ASEL CODE

103.100

OEM Reference

411 151 003 0 / 411 151 008 0 / 906 130 07 15 / 906 130 11 15 / 906 130 28 15
906 130 41 15 / 1517937

**Kullanılan Araç
Vehicle Application**

AXOR / ATEGO



Technical Data

Cylinder Bore	Ø 85.00 mm
Swept Volume	352 cc
Stroke	62 mm

103.200

Complete Cylinder Head



OEM Ref. 000 131 51 19 / 000 131 53 19
411 151 803 2 / 411 154 800 2

103.210

Cylinder Head



OEM Ref

103.250

Plate



OEM Ref.

103.300

Full Repair Kit

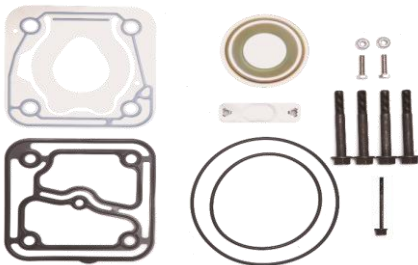

OEM Ref. 411 151 925 2

103.320

Repair Kit

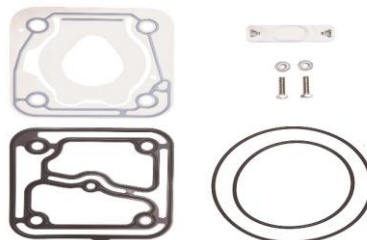

OEM Ref. 411 154 000 2

103.350

Gasket Kit

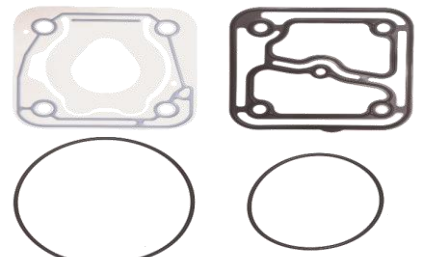

OEM Ref. 000 130 68 15
411 154 000 2

103.150

Crankcase



OEM Ref. 411 154 012 6 / 412 352 016 2

103.400

Valve Kit

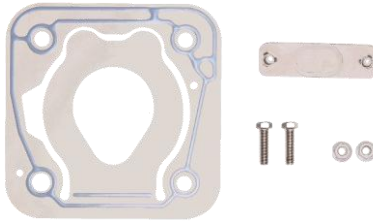

OEM Ref.

103.450

Connecting Rod



OEM Ref. 000 131 27 17
411 151 732 2 / 51.54106 6032

103.750

Bushing



OEM Ref.

103.800

Crankshaft



OEM Ref.

103.820

Gear



OEM Ref. 895 905 169 4 / 906 132 03 05

101.500

Ø 85,00 mm

Piston

101.510

Ø 85,25 mm

101.520

Ø 85,50 mm



OEM Ref.

101.550

Ø 85,00 mm

Piston & Ring

101.560

Ø 85,25 mm

101.570

Ø 85,50 mm



OEM Ref. 0697442 / 1698686 / 128371
000 130 34 17 / 911 501 624 2 / 911 501 625 2

101.600

Ø 85,00 mm

Ring

101.610

Ø 85,25 mm

101.620

Ø 85,50 mm



OEM Ref. 3094621
911 501 920 2

101.830

Crankshaft Flange



OEM Ref. 000 131 29 32
411 147 603 4

ASEL CODE

103.110

OEM Reference

411 154 004 0 / 411 154 005 0 / 906 130 42 15 / 906 130 12 15 / 906 130 51 15 / 906 130 60 15 / 906 130 61 15 / 906 130 58 15

**Kullanılan Araç
Vehicle Application**

ATEGO / AXOR 3229 / EURO 4



Technical Data

Cylinder Bore	Ø 85.00 mm
Swept Volume	352 cc
Stroke	62 mm

103.205

Complete Cylinder Head



OEM Ref. 001 130 79 15
411 154 002 2

103.220

Cylinder Head



OEM Ref

103.270

Plate



OEM Ref.

103.310

Full Repair Kit

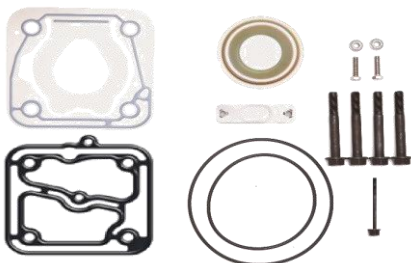

OEM Ref. 411 151 925 2

103.330

Repair Kit

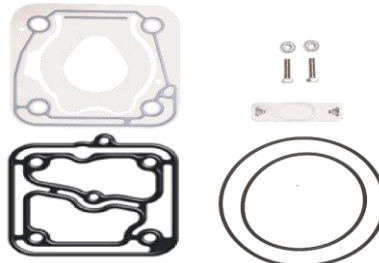

OEM Ref. 411 154 003 2

103.360

Gasket Kit

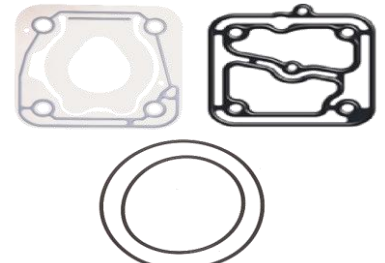

OEM Ref. 001 130 33 15

103.150

Crankcase



OEM Ref. 411 154 012 6 / 412 352 016 2

103.400

Valve Kit

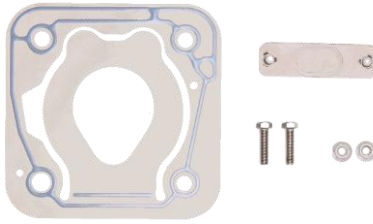

OEM Ref.

103.450

Connecting Rod



OEM Ref. 000 131 27 17
411 151 732 2 / 51.54106 6032

103.750

Bushing



OEM Ref.

103.800

Crankshaft



OEM Ref.

103.820

Gear



OEM Ref. 895 905 169 4 / 906 132 03 05

101.500

Ø 85,00 mm

Piston

101.510

Ø 85,25 mm

101.520

Ø 85,50 mm



OEM Ref.

101.550

Ø 85,00 mm

Piston & Ring

101.560

Ø 85,25 mm

101.570

Ø 85,50 mm



OEM Ref. 0697442 / 1698686 / 128371
000 130 34 17 / 911 501 624 2 / 911 501 625 2

101.600

Ø 85,00 mm

Ring

101.610

Ø 85,25 mm

101.620

Ø 85,50 mm



OEM Ref. 3094621
911 501 920 2

101.830

Crankshaft Flange



OEM Ref. 000 131 29 32
411 147 603 4

401.830

ASEL CODE

104.100

OEM Reference

911 553 100 0 / 911 553 101 0 / 911 553 104 0 / 457 130 12 15 / 457 130 19 15 / 457 130 25 15
457 130 27 15

**Kullanılan Araç
Vehicle Application**

AXOR / OM 457



Technical Data

Cylinder Bore	Ø 85.00 mm
Swept Volume	636 cc
Stroke	56 mm

104.200

Complete Cylinder Head



OEM Ref. 001 130 08 15
911 553 001 2

104.210

Cylinder Head



OEM Ref

104.250

Plate



OEM Ref.

104.270

Cooling Plate



OEM Ref.

104.300

Full Repair Kit

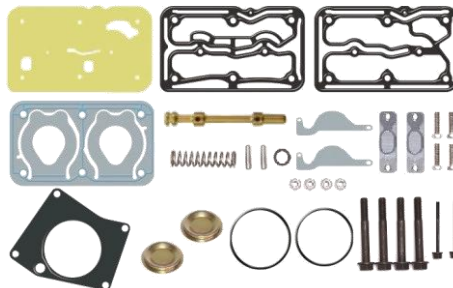

OEM Ref.

104.310

Repair Kit

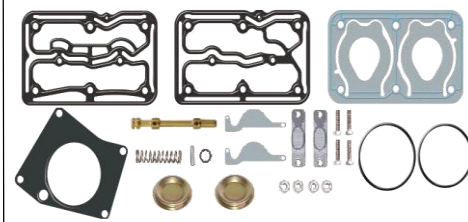

OEM Ref.

104.320 **Repair Kit**

OEM Ref. 911 553 922 2

104.330 **Repair Kit**

OEM Ref. 001 130 69 15
911 553 926 2

104.350 **Gasket Kit**

OEM Ref. 001 130 28 15
911 553 923 2 / 911 553 925 2

104.400 **Valve Kit**

OEM Ref.

104.410 **Valve Kit**

OEM Ref.

104.150 **Crankcase**

OEM Ref.

101.500 **Ø 85,00 mm** **Piston**

101.510 **Ø 85,25 mm**

101.520 **Ø 85,50 mm**

OEM Ref.

101.550 **Ø 85,00 mm** **Piston & Ring**

101.560 **Ø 85,25 mm**

101.570 **Ø 85,50 mm**

OEM Ref. 000 130 34 17 / 000 130 53 17
911 501 624 2 / 911 501 625 2

101.600 **Ø 85,00 mm** **Ring**

101.610 **Ø 85,25 mm**

101.620 **Ø 85,50 mm**

OEM Ref. 001 131 11 11
911 501 920 2

101.450 **Connecting Rod**

OEM Ref. 000 131 25 17
000 131 29 17 / 911 145 738 2
912 000 730 2 / 51.54106-6023

101.750 **Bushing**

OEM Ref. 911 553 204 4

102.800 **Crankshaft**

OEM Ref. 911 553 694 4

101.820 **Gear**

OEM Ref. 457 132 09 05
895 905 188 4

101.830 **Crankshaft Flange**

OEM Ref. 000 131 29 32
411 147 603 4

ASEL CODE

105.100

OEM Reference

**Kullanılan Araç
Vehicle Application**

OM501 / 502 / V6N / V8N / ACTROS



Technical Data

Cylinder Bore	Ø 100.00 mm
Swept Volume	722 cc
Stroke	46 mm

105.200

Complete Cylinder Head

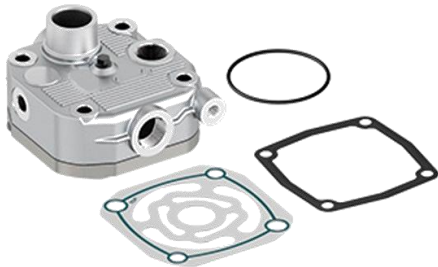

OEM Ref. 541 130 18 19

105.201

Complete Cylinder Head

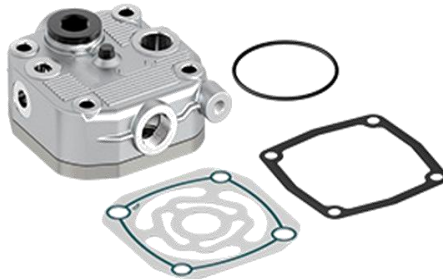

OEM Ref

105.210

Cylinder Head



OEM Ref. 541 131 06 19 / 541 131 07 19
541 131 11 19

105.220

Cylinder Head



OEM Ref. 541 131 09 19 / 541 131 10 19
541 131 12 19

105.250

Plate

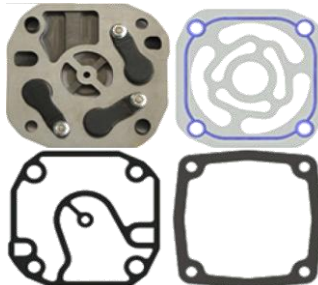

OEM Ref. 541 130 06 20

105.300

Full Repair Kit

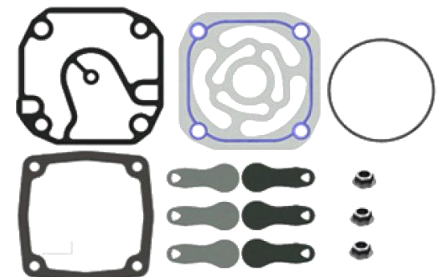

OEM Ref.

105.320 Repair Kit

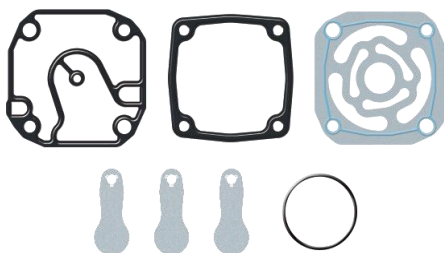

OEM Ref.

105.350 Gasket Kit

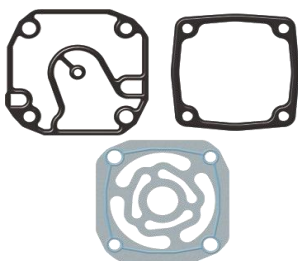

OEM Ref.

105.450 Connecting Rod



OEM Ref. 541 131 06 17 / 541 131 02 17

105.700 Cylinder Liner Kit



OEM Ref. 541 130 01 08

2,50*2,50*4,00

105.710 Cylinder Liner Kit

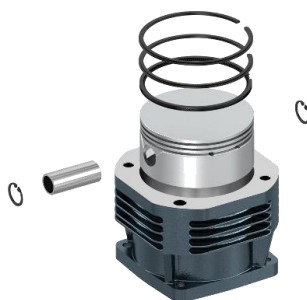

OEM Ref.

2,50*2,50*4,00

105.720 Cylinder Liner



OEM Ref.

105.500 Ø 100,00 mm Piston

105.510 Ø 100,25mm

105.520 Ø 100,50mm



OEM Ref.

2,50*2,50*4,00

105.550 Ø 100,00 mm Piston & Ring

105.560 Ø 100,25mm

105.570 Ø 100,50mm



OEM Ref.

2,50*2,50*4,00

105.600 Ø 100,00 mm Ring

105.610 Ø 100,25mm

105.620 Ø 100,50mm



OEM Ref.

2,50*2,50*4,00

105.580 Ø 100,00 mm

105.585 Ø 100,25mm

105.590 Ø 100,50mm



OEM Ref. 541 131 02 07
541 130 02 17 / 541 131 02 07
2,50*2,50*3,00

105.750 Bushing



OEM Ref. 541 131 01 45
541 132 01 45

105.800 Crankshaft



OEM Ref. 541 130 02 14
541 131 04 16

105.820 Gear



OEM Ref. 442 130 03 20
541 130 02 30 / 541 130 06 30

105.830 Crankshaft Flange



OEM Ref. 541 131 02 42

ASEL CODE**106.100****OEM Reference**

411 034 501 0 / 411 142 711 0 / 001 131 52 01 / 001 131 54 01 / 001 131 55 01 / 002 131 36 01

**Kullanılan Araç
Vehicle Application**

OM 355 / 356

**Technical Data**

Cylinder Bore	Ø 90.00 mm
Swept Volume	229 cc
Stroke	36 mm

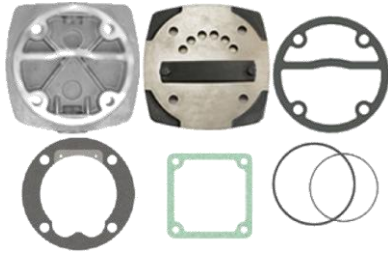
106.200**Complete Cylinder Head**

OEM Ref.

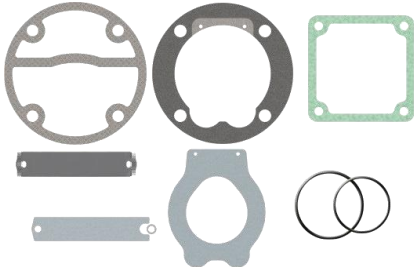
106.210**Cylinder Head**OEM Ref 000 131 31 19
411 035 652 2**106.250****Plate**OEM Ref. 000 130 13 20
411 034 500 2**106.300****Full Repair Kit**

OEM Ref.

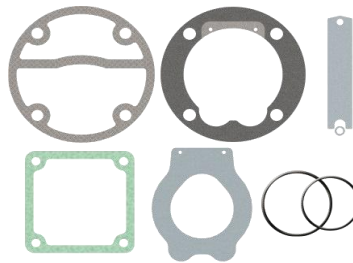
106.320**Repair Kit**

OEM Ref.

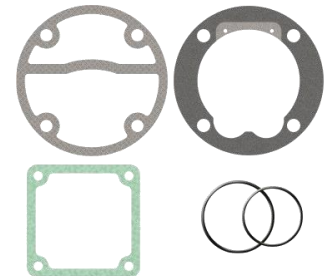
106.350**Gasket Kit**

OEM Ref.

106.150

Crankcase



OEM Ref.

106.400

Valve Kit



OEM Ref.

106.450

Connecting Rod



OEM Ref. 000 131 24 16

106.775

Connecting Rod Bearing Kit



OEM Ref. 000 131 21 50
411 042 341 4

106.700

Cylinder Liner Kit



OEM Ref. 000 131 45 60 / 000 130 02 08
001 131 55 01

106.720

Cylinder Liner Kit



OEM Ref. 000 131 28 02 / 001 131 36 02
411 034 570 4

106.500

Ø 90,00 mm Piston



OEM Ref.

106.550

Ø 90,00 mm Piston & Ring



OEM Ref. 000 130 11 17
411 042 620 2

106.600

Ø 90,00 mm Ring



OEM Ref. 3094621
911 501 920 2

106.510

Ø 90,25 mm

106.560

Ø 90,25 mm

106.610

Ø 90,25 mm

106.520

Ø 90,50 mm

106.570

Ø 90,50 mm

106.620

Ø 90,50 mm

106.800

Crankshaft



OEM Ref. 000 131 19 16

106.830

Crankshaft Flange



OEM Ref. 000 130 02 32
411 042 660 2

106.840

Pump Support



OEM Ref. 000 131 03 42
411 042 600 4

ASEL CODE

107.100

OEM Reference

004 131 94 01 / 004 131 77 01 / 004 131 74 01 / LK1813 / II14570

**Kullanılan Araç
Vehicle Application**

2521 / OM 355 / OM 362 / OM 364 / OM 366



Technical Data

Cylinder Bore	Ø 88.00 mm
Swept Volume	225 cc
Stroke	37 mm

107.200

Complete Cylinder Head

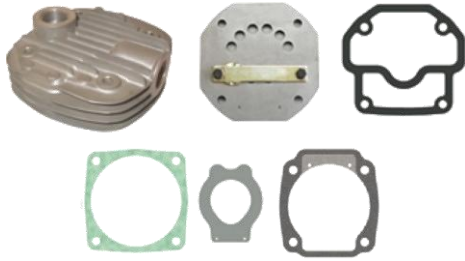

OEM Ref.

107.210

Cylinder Head



OEM Ref 000 131 45 19

107.250

Plate

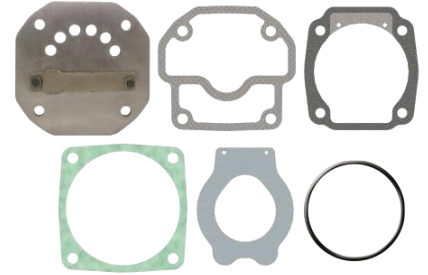

OEM Ref. 000 130 71 20
II38714F004 / I80398004

107.300

Full Repair Kit

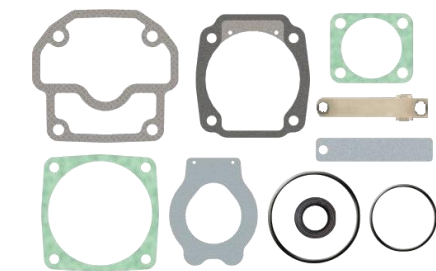

OEM Ref.

107.320

Repair Kit

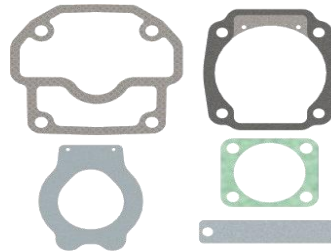

OEM Ref. STW63784

107.350

Gasket Kit

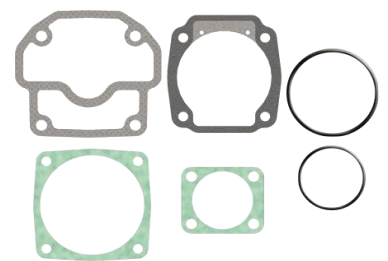

OEM Ref.

107.150

Crankcase



OEM Ref.

107.400

Valve Kit

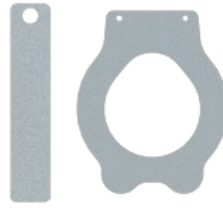

OEM Ref.

107.450

Connecting Rod



OEM Ref. 000 131 18 17 / 000 130 19 16
000 130 25 17 / I80110 / I60599

107.700

Cylinder Liner Kit



OEM Ref. I808640061

107.720

Cylinder Liner



OEM Ref. 000 131 42 02
C63059

107.750

Bushing



OEM Ref. 000 131 31 50
B44935

107.500

Ø 88,00 mm

Piston

107.510

Ø 88,25 mm

10.520

Ø 88,50 mm



OEM Ref.

107.550

Ø 88,00 mm

Piston & Ring

107.560

Ø 88,25 mm

107.570

Ø 88,50 mm



OEM Ref. 000 130 11 17
411 042 620 2

107.600

Ø 88,00 mm

Ring

107.610

Ø 88,25 mm

107.620

Ø 88,50 mm



OEM Ref. 001 131 06 11
I139526F0061

107.800

Crankshaft



OEM Ref. 000 131 46 16 / 000 131 59 16 / 000 131 60 16

107.830

Crankshaft Flange



OEM Ref.

OEM Ref.

ASEL CODE

108.100

OEM Reference

447 130 20 15 / 447 130 33 15

**Kullanılan Araç
Vehicle Application**

OM 447 / EURO 1

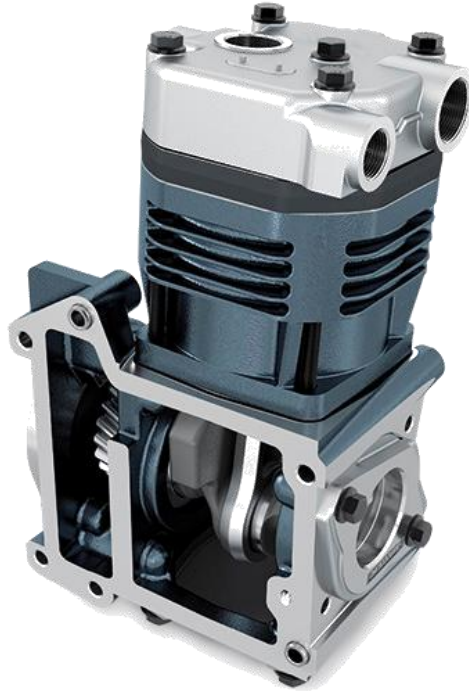

Technical Data

Cylinder Bore	Ø 100.00 mm
Swept Volume	377 cc
Stroke	48 mm

108.200

Complete Cylinder Head

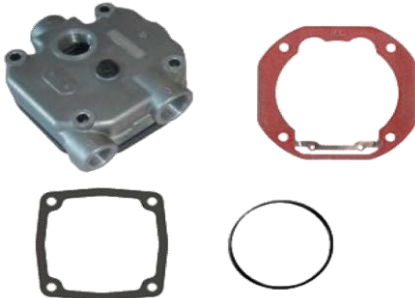

OEM Ref. 442 130 34 19

108.210

Cylinder Head



OEM Ref 442 130 32 19

108.250

Plate



OEM Ref. 441 130 00 20 / 441 130 01 20 / 441 130 02 20

108.300

Full Repair Kit

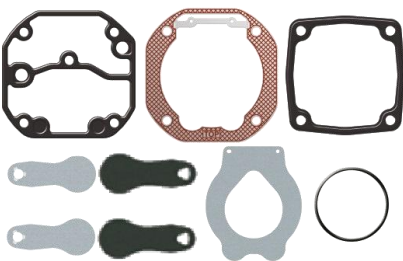

OEM Ref.

108.320

Repair Kit

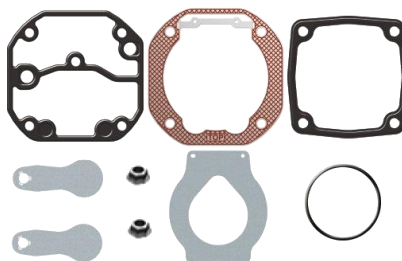

OEM Ref.

108.350

Gasket Kit

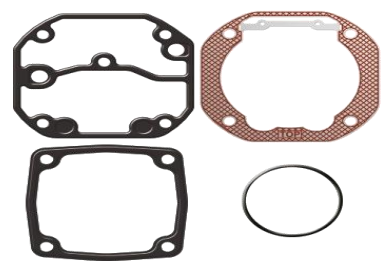

OEM Ref.

108.150 Crankcase



OEM Ref. 447 131 03 15

108.400 Valve Kit



OEM Ref.

108.450 Connecting Rod



OEM Ref.

108.700 Cylinder Liner Kit



OEM Ref. 441 130 00 08

108.720 Cylinder Liner



OEM Ref.

108.750 Bushing



OEM Ref.

105.500 Ø 100,00 mm Piston



OEM Ref. 2,50*2,50*4,00

105.550 Ø 100,00 mm Piston & Ring



OEM Ref. 2,50*2,50*4,00

105.600 Ø 100,00 mm Ring



OEM Ref. 2,50*2,50*4,00

105.510 Ø 100,25mm

105.560 Ø 100,25mm

105.610 Ø 100,25mm

105.520 Ø 100,50mm

105.570 Ø 100,50mm

105.620 Ø 100,50mm

108.800 Crankshaft

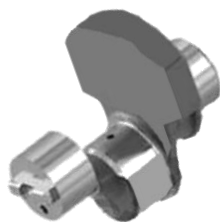

OEM Ref. 447 130 00 14
442 130 01 14

108.820 Gear



OEM Ref. 447 132 02 05

108.830 Crankshaft Flange



OEM Ref. 442 131 13 42

ASEL CODE

109.100

OEM Reference

004 131 58 01 / 003 131 48 01 / 003 131 63 01 / LK1511 / LK1527 / LK1532 / LK1550
I83539 / I88770 / I99942

**Kullanılan Araç
Vehicle Application**

OM 355 / OM 362 / OM 366 / LA SERIES

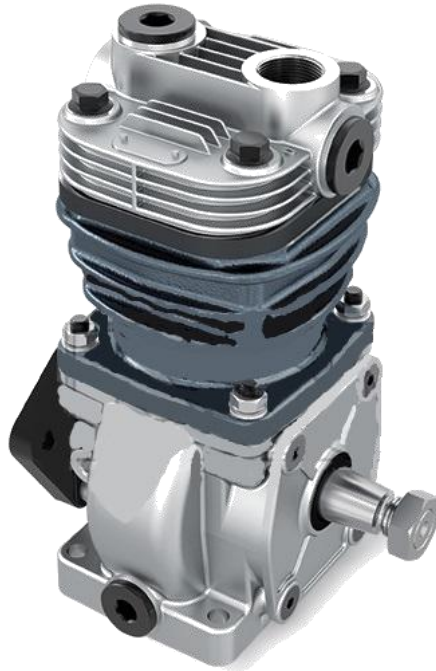

Technical Data

Cylinder Bore	Ø 75.00 mm
Swept Volume	155 cc
Stroke	35 mm

109.200

Complete Cylinder Head



OEM Ref. STW63841

109.210

Cylinder Head



OEM Ref 000 131 27 1
II38602F004

109.250

Plate

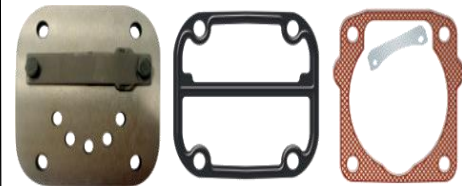

OEM Ref. 000 130 49 20
II138717F004 / I80408-004

109.300

Full Repair Kit

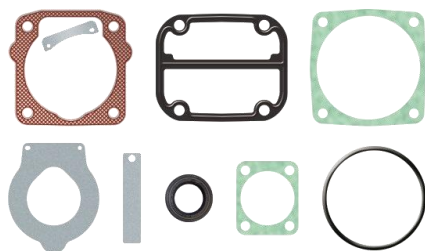

OEM Ref.

109.320

Repair Kit

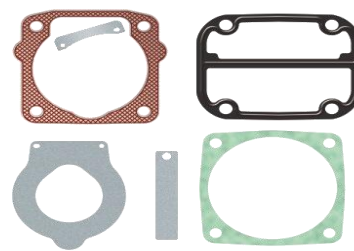

OEM Ref.

109.350

Gasket Kit

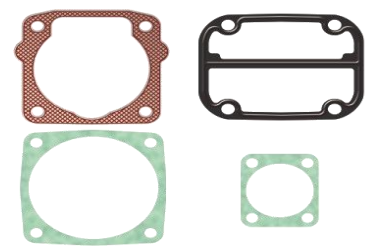

OEM Ref.

109.150 Crankcase

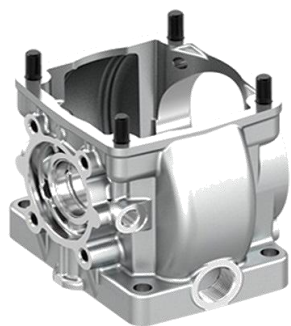

OEM Ref.

109.400 Valve Kit

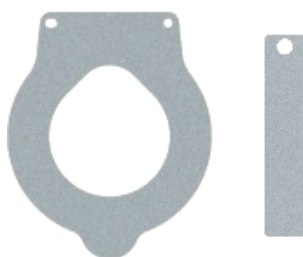

OEM Ref.

107.450 Connecting Rod



OEM Ref. 000 131 18 17 / 000 130 19 16
000 130 25 17 / I80110 / I60599

109.700 Cylinder Liner Kit



OEM Ref. 000 131 42 02
ZB4265 / I177246

109.720 Cylinder Liner



OEM Ref. 000 131 34 02

107.750 Bushing



OEM Ref. 000 131 31 50
B44935

109.500 Ø 75,00 mm Piston



OEM Ref.

109.550 Ø 75,00 mm Piston & Ring



OEM Ref. SEB22539 / SEB22540

109.600 Ø 75,00 mm Ring



OEM Ref. I801770061

109.510 Ø 75,25mm

109.560 Ø 75,25mm

109.610 Ø 75,25mm

109.520 Ø 75,50mm

109.570 Ø 75,50mm

109.620 Ø 75,50mm

109.800 Crankshaft

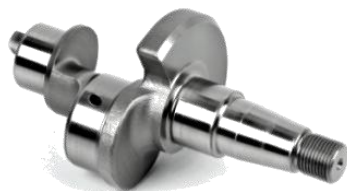

OEM Ref.

107.830 Crankshaft Flange



OEM Ref.

109.840 Pump Support



OEM Ref.

ASEL CODE

110.100

OEM Reference

**Kullanılan Araç
Vehicle Application**

MB 407

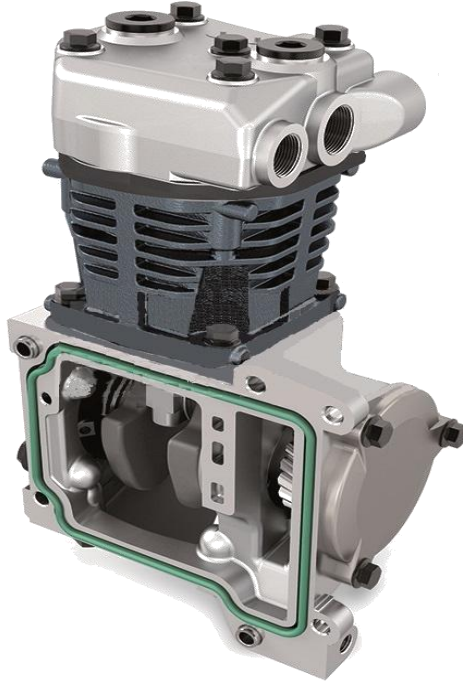

Technical Data

Cylinder Bore	Ø 90.00 mm
Swept Volume	292 cc
Stroke	46 mm

110.200

Complete Cylinder Head

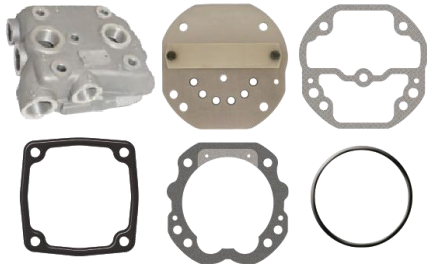

OEM Ref. ZB4187 / ZB4224 ZB4229
000 130 24 19 / 000 130 25 19 / 000 130 26 19

110.210

Cylinder Head



OEM Ref 407 131 05 19

110.250

Plate

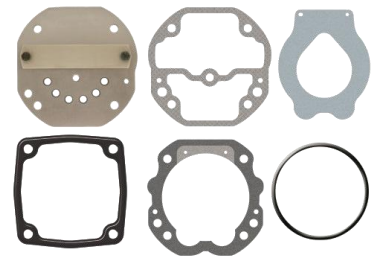

OEM Ref. 402 130 01 20 / 402 130 03 20

110.300

Full Repair Kit

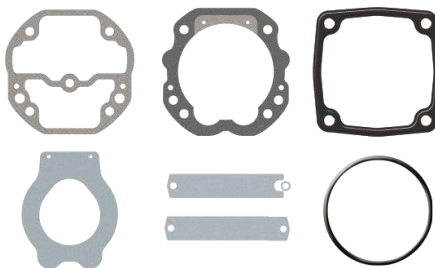

OEM Ref.

110.320

Repair Kit

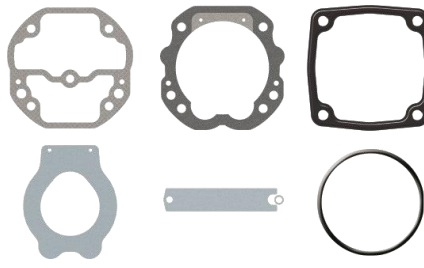

OEM Ref. 402 130 00 20 / 402 130 02 20 / 402 586 50 13

110.350

Gasket Kit

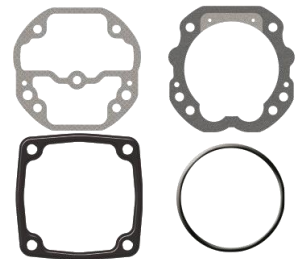

OEM Ref.

110.150 Crankcase

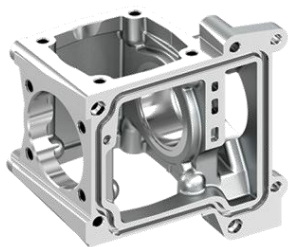

OEM Ref. 407 130 06 10

110.400 Valve Kit



OEM Ref.

110.450 Connecting Rod



OEM Ref. 403 130 28 16 / 403 130 22 16

110.700 Cylinder Liner Kit



OEM Ref. 403 130 00 08 / 403 131 00 02 / 442 130 00 02 403 130 01 17 / 442 130 00 08 / 51 54160 6005 / 51 54105 0007 / 51 54105 6008

110.720 Cylinder Liner



OEM Ref. 403 131 20 02
51 54160 6006

110.775 Connecting Rod Bearing Kit



OEM Ref. 403 131 02 33

110.500 Ø 90,00 mm Piston



OEM Ref. 403 130 05 17

110.550 Ø 90,00 mm Piston & Ring



OEM Ref.

106.600 Ø 90,00 mm Ring



OEM Ref.

110.510 Ø 90,25mm

110.560 Ø 90,25mm

106.610 Ø 90,25mm

110.520 Ø 90,50mm

110.570 Ø 90,50mm

106.620 Ø 90,50mm

110.800 Crankshaft



OEM Ref. 403 131 07 16

110.820 Gear



OEM Ref. 466 132 00 05

110.830 Crankshaft Flange



OEM Ref. 403 130 16 45 / 403 130 06 45 / 403 130 08 45

ASEL CODE

111.100

OEM Reference

407 130 01 15 / 496 130 01 15

**Kullanılan Araç
Vehicle Application**

MB 407 / OM 447 / EURO 1

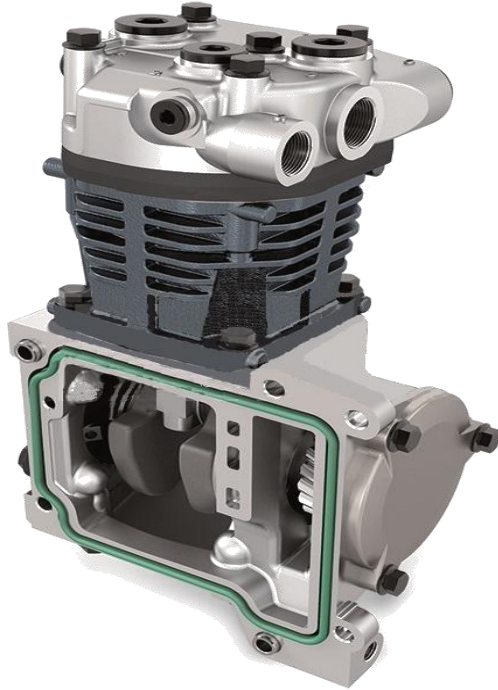

Technical Data

Cylinder Bore	Ø 90.00 mm
Swept Volume	292 cc
Stroke	46 mm

111.200

Complete Cylinder Head

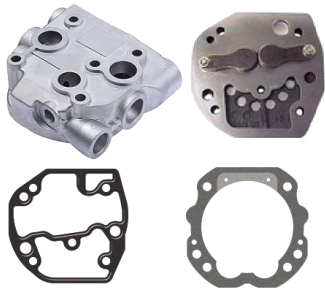

OEM Ref. 447 130 00 19

111.201

Cylinder Head



OEM Ref

111.210

Plate



OEM Ref. 407 130 05 19 / 407 130 02 19 / 442 130 31 19

111.250

Plate

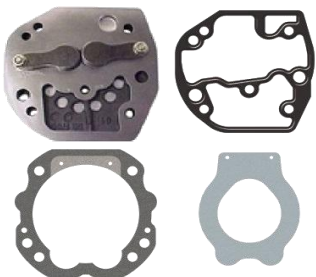

OEM Ref. 442 130 07 20 / 447 130 07 20

111.260

Plate



OEM Ref.

111.300

Full Repair Kit

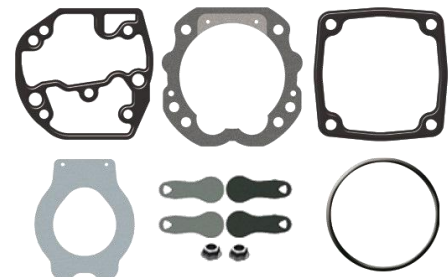

OEM Ref.

111.310 Full Repair Kit

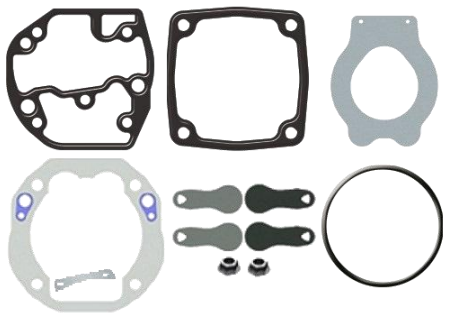

OEM Ref.

111.320 Repair Kit

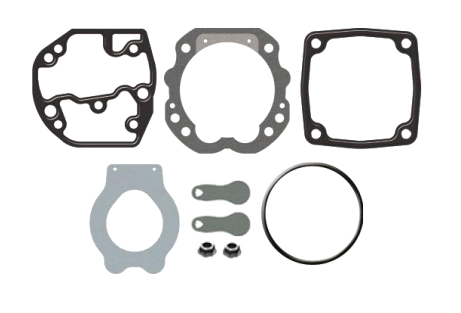

OEM Ref. 442 130 00 20

111.330 Repair Kit

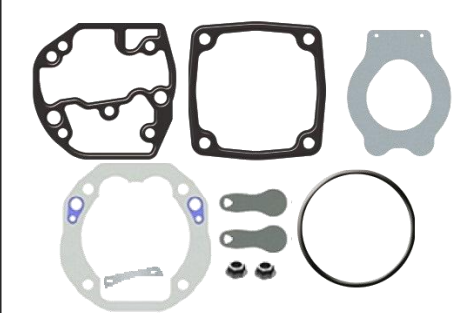

OEM Ref.

111.350 Gasket Kit



OEM Ref.

111.360 Gasket Kit

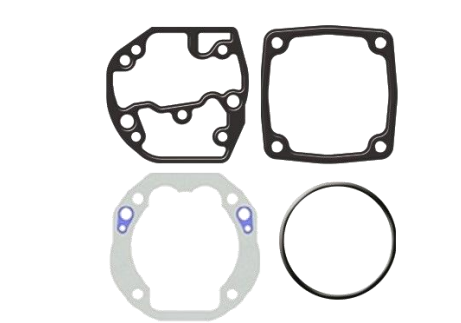

OEM Ref.

111.400 Valve Kit



OEM Ref.

110.500 Ø 90,00 mm Piston

110.510 Ø 90,25mm

110.520 Ø 90,50mm



OEM Ref. 403 130 05 17

110.550 Ø 90,00 mm Piston & Ring

110.560 Ø 90,25mm

110.570 Ø 90,50mm



OEM Ref. SEB22539 / SEB22540

106.600 Ø 90,00 mm Ring

106.610 Ø 90,25mm

106.620 Ø 90,50mm



OEM Ref. I801770061

110.800 Crankshaft



OEM Ref. 403 131 07 16

110.820 Gear



OEM Ref. 466 132 00 05

110.830 Crankshaft Flange



OEM Ref. 403 130 16 45 / 403 130 06 45 / 403 130 08 45

ASEL CODE

112.100

OEM Reference

447 130 28 15

**Kullanılan Araç
Vehicle Application**

EURO 2 / BUS

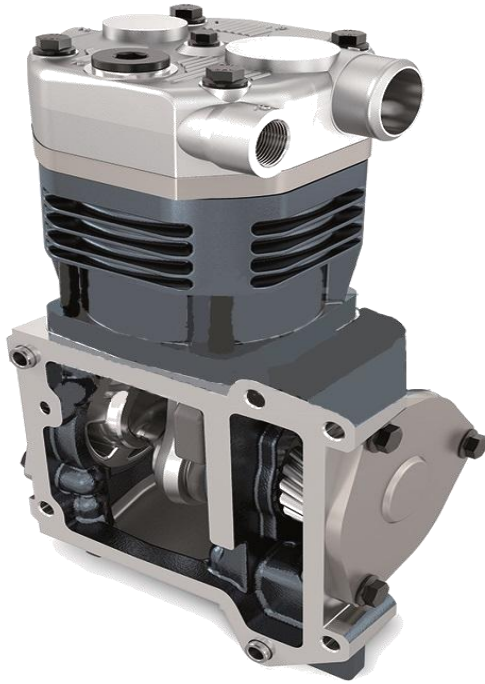

Technical Data

Cylinder Bore	Ø 100.00 mm
Swept Volume	377 cc
Stroke	48 mm

112.200

Complete Cylinder Head

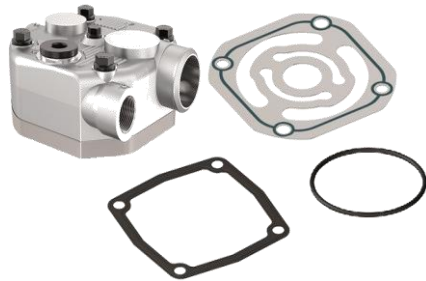

OEM Ref. 442 131 71 19

112.210

Cylinder Head

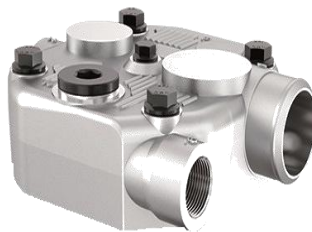

OEM Ref 442 131 05 19

112.250

Plate

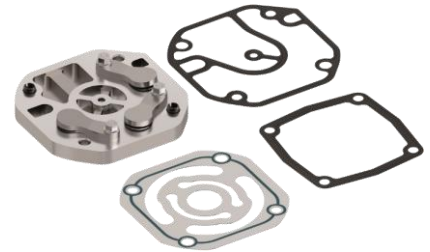

OEM Ref. 442 130 11 20

112.300

Full Repair Kit

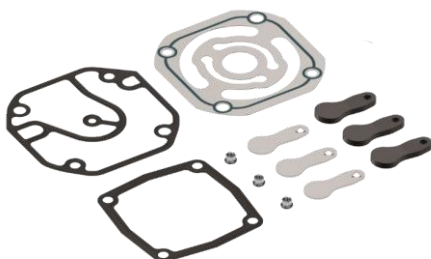

OEM Ref.

112.320

Repair Kit

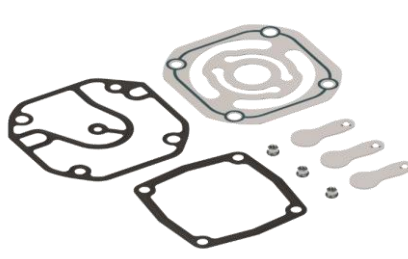

OEM Ref.

112.350

Gasket Kit

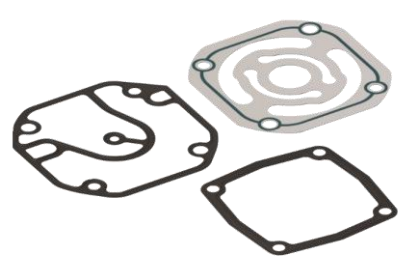

OEM Ref.

108.150

Crankcase

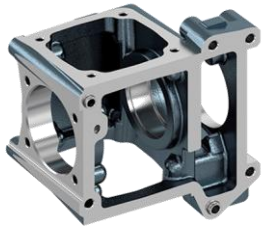

OEM Ref. 447 131 03 15

112.400

Valve Kit

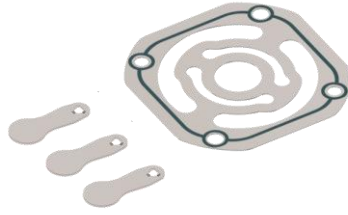

OEM Ref.

108.450

Connecting Rod



OEM Ref.

112.700

Cylinder Liner Kit

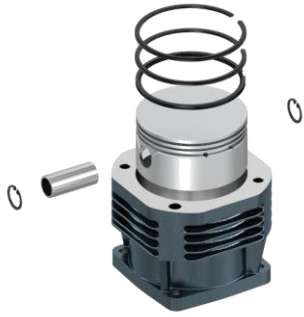

OEM Ref. 442 130 01 08

112.720

Cylinder Liner



OEM Ref.

108.750

Bushing



OEM Ref.

105.500

∅ 100,00 mm

Piston

105.510

∅ 100,25mm

105.520

∅ 100,50mm



OEM Ref.

2,50*2,50*4,00

105.550

∅ 100,00 mm Piston & Ring

105.560

∅ 100,25mm

105.570

∅ 100,50mm



OEM Ref.

2,50*2,50*4,00

105.600

∅ 100,00 mm

Ring

105.610

∅ 100,25mm

105.620

∅ 100,50mm



OEM Ref.

2,50*2,50*4,00

108.800

Crankshaft

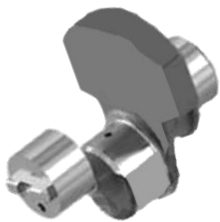

OEM Ref. 447 130 00 14
442 130 01 14

108.820

Gear



OEM Ref. 447 132 02 05

108.830

Crankshaft Flange



OEM Ref. 442 131 13 42

ASEL CODE**113.100****OEM Reference**

407 130 06 15 / 407 130 07 15 / 407 130 17 15 / 51 54000 7178

**Kullanılan Araç
Vehicle Application**

OM 407 SERIES / MB 407

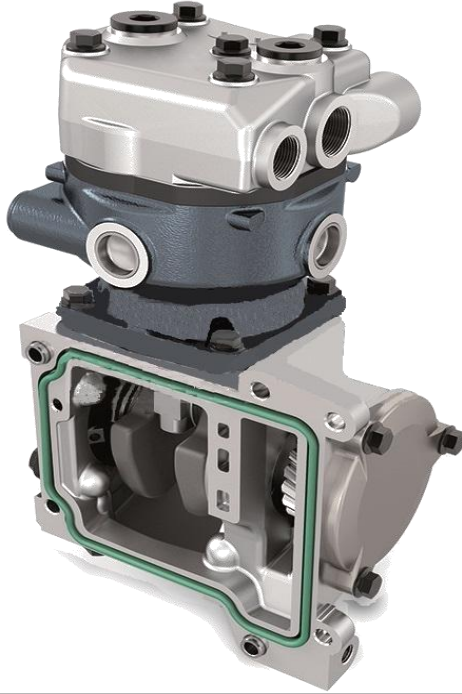
**Technical Data**

Cylinder Bore	Ø 90.00 mm
Swept Volume	292 cc
Stroke	46 mm

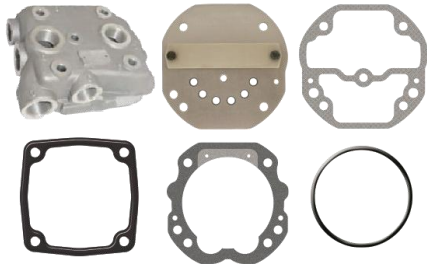
110.200**Complete Cylinder Head**OEM Ref. ZB4187 / ZB4224 ZB4229
000 130 24 19 / 000 130 25 19 / 000 130 26 19**110.210****Cylinder Head**

OEM Ref 407 131 05 19

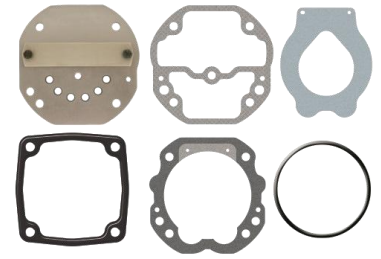
110.250**Plate**

OEM Ref. 402 130 01 20 / 402 130 03 20

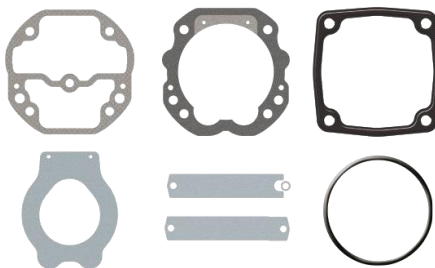
110.300**Full Repair Kit**

OEM Ref.

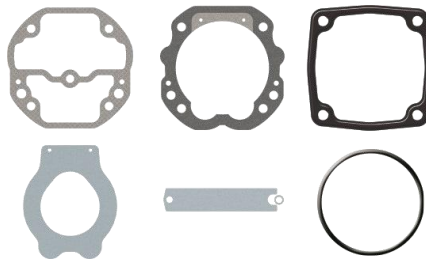
110.320**Repair Kit**

OEM Ref. 402 130 00 20 / 402 130 02 20 / 402 586 50 13

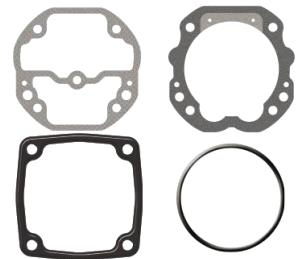
110.350**Gasket Kit**

OEM Ref.

110.150 Crankcase

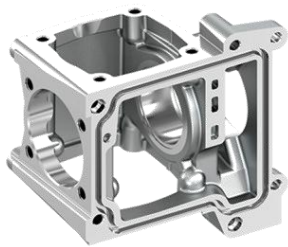

OEM Ref. 407 130 06 10

110.400 Valve Kit

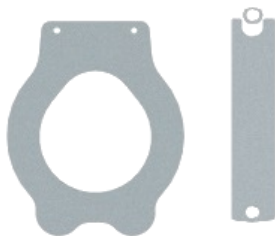

OEM Ref.

110.450 Connecting Rod



OEM Ref. 403 130 28 16 / 403 130 22 16

113.700 Cylinder Liner Kit



OEM Ref. 402 130 06 08 / 402 130 02 08 / 427 130 00 08
402 131 05 02

113.720 Cylinder Liner



OEM Ref. STW63740 / 402 130 03 08

110.775 Connecting Rod Bearing Kit



OEM Ref. 403 131 02 33

110.500 Ø 90,00 mm Piston



OEM Ref. 403 130 05 17

110.550 Ø 90,00 mm Piston & Ring



OEM Ref.

106.600 Ø 90,00 mm Ring



OEM Ref.

110.510 Ø 90,25mm

110.560 Ø 90,25mm

106.610 Ø 90,25mm

110.520 Ø 90,50mm

110.570 Ø 90,50mm

106.620 Ø 90,50mm

110.800 Crankshaft



OEM Ref. 403 131 07 16

110.820 Gear



OEM Ref. 466 132 00 05

110.830 Crankshaft Flange



OEM Ref. 403 130 16 45 / 403 130 06 45 / 403 130 08 45

ASEL CODE

114.100

OEM Reference

407 130 05 15 / 496 130 00 15

**Kullanılan Araç
Vehicle Application**

OM 457 / OM 405 / OM 407

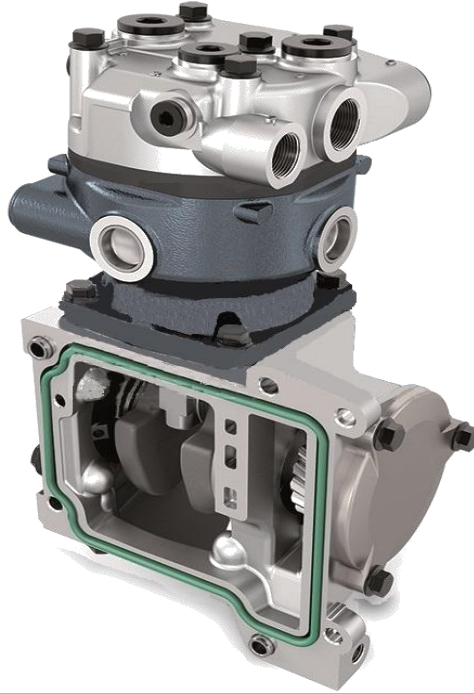

Technical Data

Cylinder Bore	Ø 90.00 mm
Swept Volume	292 cc
Stroke	46 mm

111.200

Complete Cylinder Head

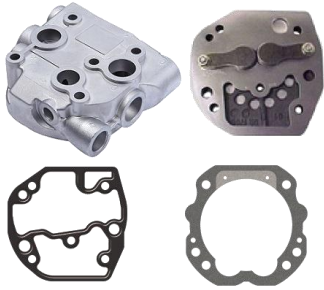

OEM Ref. 447 130 00 19

111.201

Cylinder Head



OEM Ref

111.210

Plate



OEM Ref. 407 130 05 19 / 407 130 02 19 / 442 130 31 19

111.250

Plate



OEM Ref. 442 130 07 20 / 447 130 07 20

111.260

Plate



OEM Ref.

111.300

Full Repair Kit

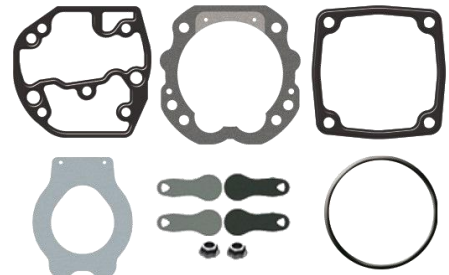

OEM Ref.

111.310 Full Repair Kit

OEM Ref.

111.320 Repair Kit

OEM Ref. 442 130 00 20

111.330 Repair Kit

OEM Ref.

111.350 Gasket Kit

OEM Ref.

111.360 Gasket Kit

OEM Ref.

111.400 Valve Kit

OEM Ref.

110.500 \varnothing 90,00 mm Piston

110.510 \varnothing 90,25mm

110.520 \varnothing 90,50mm

OEM Ref. 403 130 05 17

110.550 \varnothing 90,00 mm Piston & Ring

110.560 \varnothing 90,25mm

110.570 \varnothing 90,50mm

OEM Ref. SEB22539 / SEB22540

106.600 \varnothing 90,00 mm Ring

106.610 \varnothing 90,25mm

106.620 \varnothing 90,50mm

OEM Ref. I801770061

110.800 Crankshaft

OEM Ref. 403 131 07 16

110.820 Gear

OEM Ref. 466 132 00 05

110.830 Crankshaft Flange

OEM Ref. 403 130 16 45 / 403 130 06 45 / 403 130 08 45

ASEL CODE

115.100

OEM Reference

407 130 17 15 / 496 130 02 15 / 496 130 00 15

**Kullanılan Araç
Vehicle Application**

MB 407

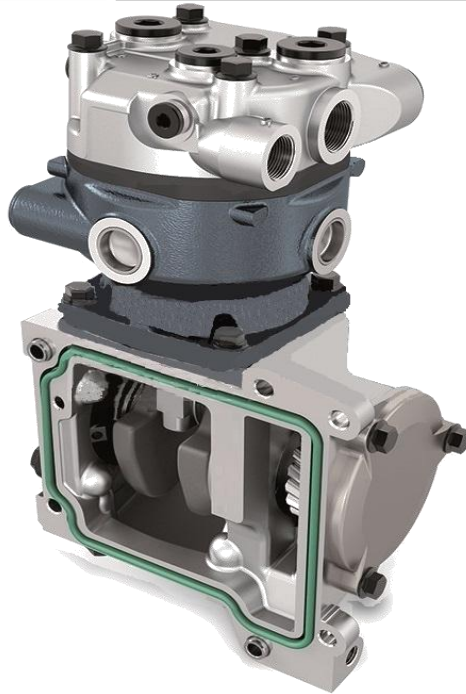

Technical Data

Cylinder Bore	Ø 90.00 mm
Swept Volume	292 cc
Stroke	46 mm

115.200

Complete Cylinder Head

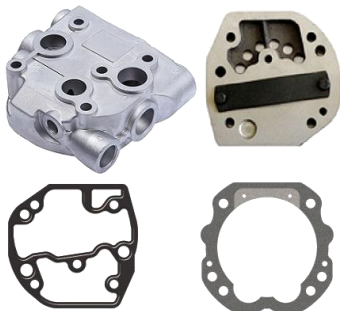

OEM Ref. 407 130 07 19

115.201

Cylinder Head

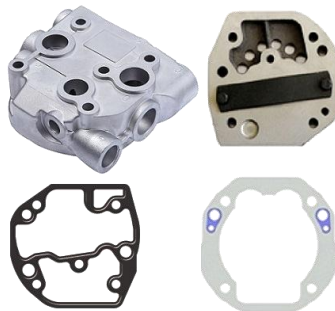

OEM Ref

111.210

Plate



OEM Ref. 407 130 05 19 / 407 130 02 19 / 442 130 31 19

115.250

Plate



OEM Ref. 442 130 02 20

115.260

Plate

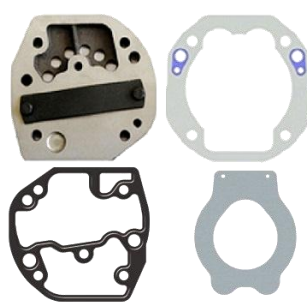

OEM Ref.

115.300

Full Repair Kit



OEM Ref.

115.310 Full Repair Kit

OEM Ref.

115.320 Repair Kit

OEM Ref.

115.330 Repair Kit

OEM Ref.

111.350 Gasket Kit

OEM Ref.

111.360 Gasket Kit

OEM Ref.

110.400 Valve Kit

OEM Ref.

110.500 Ø 90,00 mm Piston

110.510 Ø 90,25mm

110.520 Ø 90,50mm

OEM Ref. 403 130 05 17

110.550 Ø 90,00 mm Piston & Ring

110.560 Ø 90,25mm

110.570 Ø 90,50mm

OEM Ref. SEB22539 / SEB22540

106.600 Ø 90,00 mm Ring

106.610 Ø 90,25mm

106.620 Ø 90,50mm

OEM Ref. I801770061

110.150 Crankshaft

OEM Ref. 407 130 06 10

110.820 Crankshaft

OEM Ref. 403 131 07 16

110.830 Gear

OEM Ref. 466 132 00 05

ASEL CODE

116.100

OEM Reference

**Kullanılan Araç
Vehicle Application**

OM 501 – 502 / V6



Technical Data

Cylinder Bore	Ø 100.00 mm
Swept Volume	377 cc
Stroke	48 mm

116.200

Complete Cylinder Head

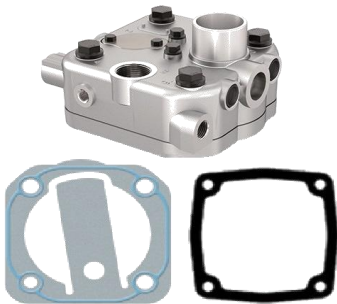

OEM Ref. 541 130 22 19 / 541 130 27 19
ZB4289

116.210

Cylinder Head



OEM Ref

116.250

Plate

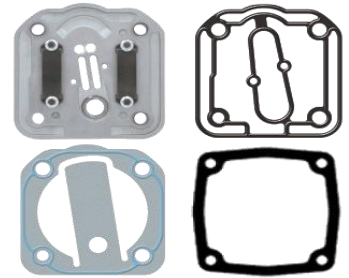

OEM Ref. 541 130 08 20 / II38147F0064

116.300

Full Repair Kit

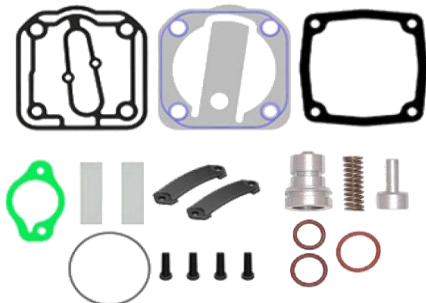

OEM Ref.

116.310

Repair Kit

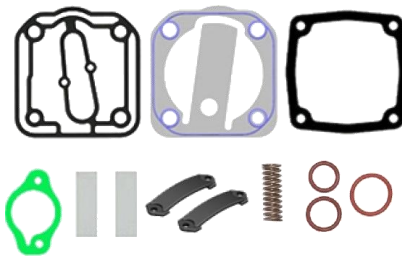

OEM Ref.

116.320

Repair Kit

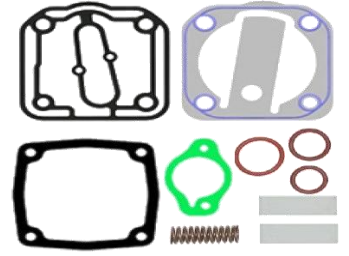

OEM Ref.

116.350

Gasket Kit

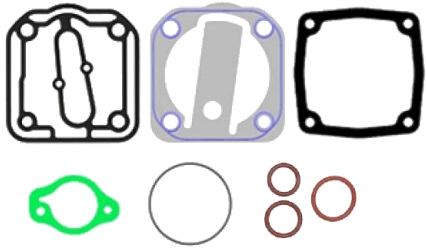

OEM Ref. 000 130 76 15

302.410

Valve Kit



OEM Ref. 541 130 77 15
I138147F0061

116.450

Connecting Rod



OEM Ref. 442 131 02 17
541 131 01 17

116.700

Cylinder Liner Kit



OEM Ref. 541 131 02 08

2,50*2,50*4,00

116.720

Liner Kit



OEM Ref.

105.750

Bushing



OEM Ref. 541 131 01 45 / 541 132 01 45

105.500

Ø 100,00 mm

Piston

105.510

Ø 100,25mm

105.520

Ø 100,50mm



OEM Ref.

2,50*2,50*4,00

105.550

Ø 100,00 mm Piston & Ring

105.560

Ø 100,25mm

105.570

Ø 100,50mm



OEM Ref.

2,50*2,50*4,00

105.600

Ø 100,00 mm

Ring

105.610

Ø 100,25mm

105.620

Ø 100,50mm



OEM Ref.

2,50*2,50*4,00

116.800

Crankshaft



OEM Ref. 442 130 03 14
541 130 05 14

105.820

Gear



OEM Ref. 442 130 03 30
541 130 02 30 / 541 130 06 30

105.830

Crankshaft Flange



OEM Ref. 541 131 01 45

ASEL CODE

117.100

OEM Reference

**Kullanılan Araç
Vehicle Application**

ACTROS / OM 501 – 502 / V TYPE / EURO 4 / EURO 5

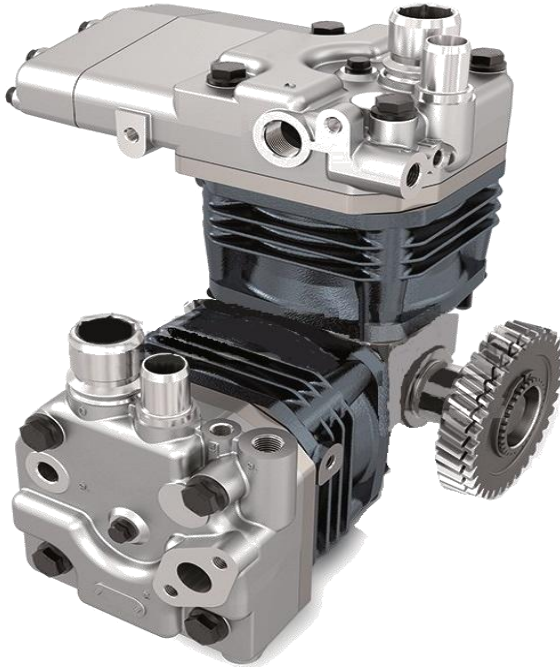

Technical Data

Cylinder Bore	Ø 100.00 mm
Swept Volume	722 cc
Stroke	46 mm

117.200

Complete Cylinder Head

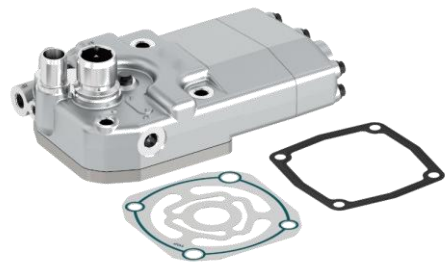

OEM Ref. 541 130 36 19

117.201

Complete Cylinder Head

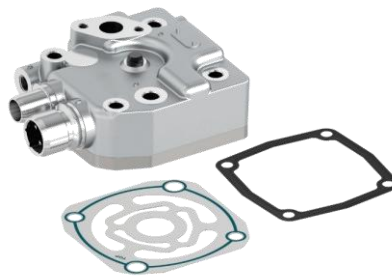

OEM Ref 541 130 37 19

117.210

Cylinder Head



OEM Ref. 407 130 05 19

117.220

Cylinder Head



OEM Ref. 442 130 02 20

117.250

Plate

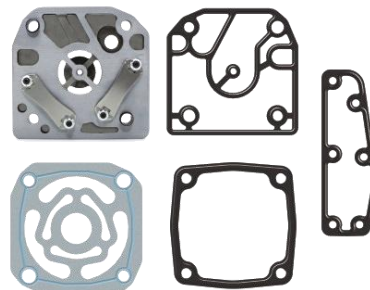

OEM Ref.

117.300

Full Repair Kit

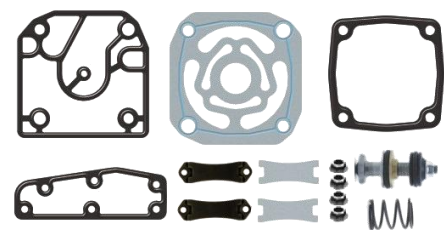

OEM Ref.

117.310

Repair Kit



OEM Ref.

117.320

Valve Kit

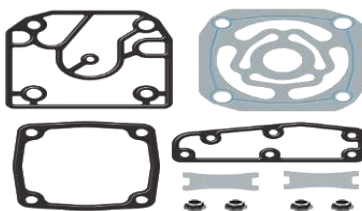

OEM Ref.

117.350

Gasket Kit

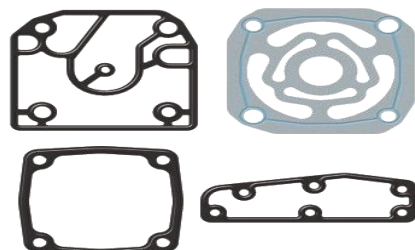

OEM Ref.

105.700

Cylinder Liner Kit



OEM Ref. 541 130 01 08

2,50*2,50*4,00

105.710

Cylinder Liner Kit

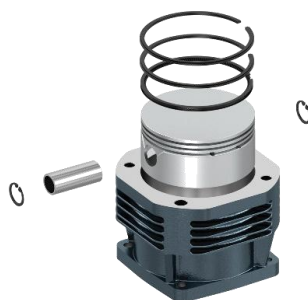

OEM Ref.

2,50*2,50*4,00

105.720

Cylinder Liner



OEM Ref.

105.500

∅ 100,00 mm

Piston

105.510

∅ 100,25mm

105.520

∅ 100,50mm



OEM Ref.

2,50*2,50*4,00

105.550

∅ 100,00 mm Piston & Ring

105.560

∅ 100,25mm

105.570

∅ 100,50mm



OEM Ref.

2,50*2,50*4,00

105.600

∅ 100,00 mm

Ring

105.610

∅ 100,25mm

105.620

∅ 100,50mm



OEM Ref.

2,50*2,50*4,00

105.580

∅ 100,25mm

105.585

∅ 100,25mm

105.590

∅ 100,50mm



OEM Ref. 541 131 02 07

541 130 02 17 / 541 131 02 07

2,50*2,50*3,00

117.400

Valve Kit



OEM Ref.

105.800

Crankshaft



OEM Ref. 541 130 02 14

541 131 04 16

105.820

Gear



OEM Ref. 442 130 03 20

541 130 02 30 / 541 130 06 30

105.830

Crankshaft Flange



OEM Ref. 541 131 02 42

ASEL CODE**118.100****OEM Reference**

457 130 05 15 / 91 153 001 0

**Kullanılan Araç
Vehicle Application**

AXOR 1840 / 3240 / ATEGO

**Technical Data**

Cylinder Bore	Ø 85.00 mm
Swept Volume	318 cc
Stroke	56 mm

118.200**Complete Cylinder Head**

OEM Ref. 411 151 920 2

118.210**Cylinder Head**OEM Ref 000 131 22 21
411 141 654 4 / 411 151 653 4**118.250****Plate**

OEM Ref.

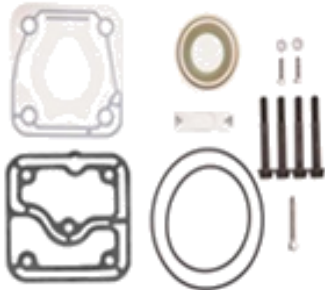
118.300**Full Repair Kit**

OEM Ref.

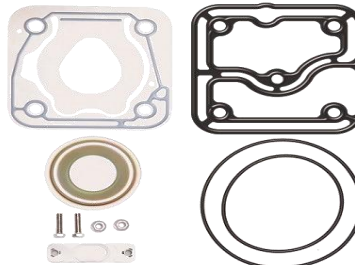
118.310**Repair Kit**

OEM Ref.

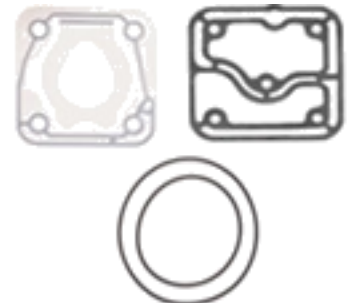
118.320**Gasket Kit**OEM Ref. 000 130 50 15
411 154 000 2

ASEL CODE

119.100

OEM Reference

411 151 000 0 / 906 130 06 15 / 906 131 05 01

**Kullanılan Araç
Vehicle Application**

AXOR / OM 904 / OM 906 / OM 924 -LA SERIES



Technical Data

Cylinder Bore	Ø 85.00 mm
Swept Volume	318 cc
Stroke	56 mm

119.200

Complete Cylinder Head



OEM Ref. 000 131 49 19
411 151 800 2 / 411 151 801 2

118.210

Cylinder Head



OEM Ref 000 131 22 21
411 141 654 4 / 411 151 653 4

119.250

Plate



OEM Ref. 000 131 08 09 / 000 131 09 09
411 151 652 2

119.300

Full Repair Kit

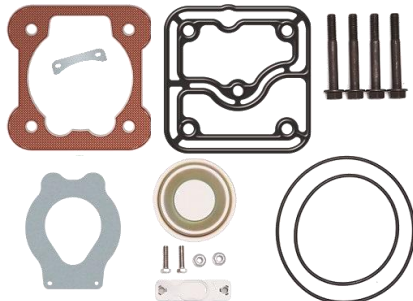

OEM Ref.

119.310

Repair Kit

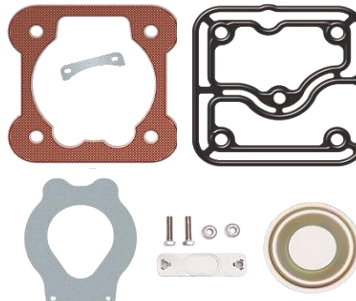

OEM Ref.

119.350

Gasket Kit

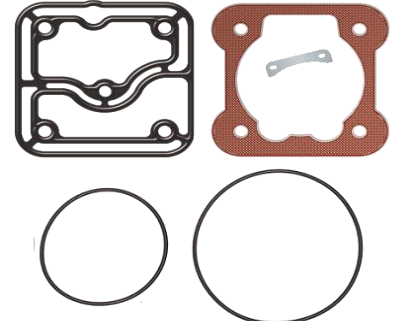

OEM Ref.

ASEL CODE

120.100

OEM Reference

**Kullanılan Araç
Vehicle Application**

OM 501 – 502 / EURO 4 / EURO 5 / V TYPE



Technical Data

Cylinder Bore	Ø 100.00 mm
Swept Volume	722 cc
Stroke	46 mm

120.200

Complete Cylinder Head

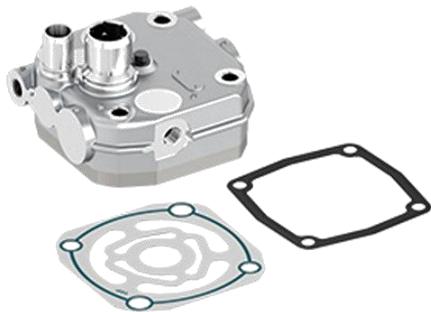

OEM Ref. 541 130 31 19

120.201

Complete Cylinder Head

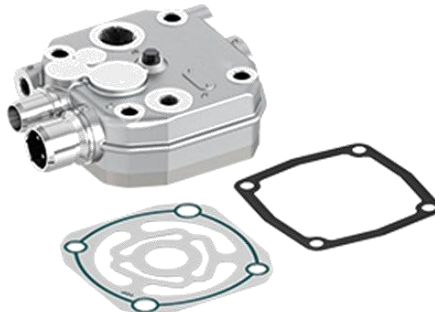

OEM Ref.541 130 32 19

120.210

Cylinder Head

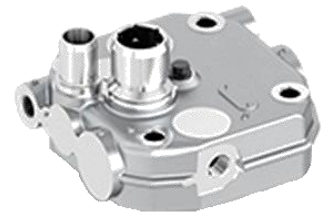

OEM Ref.

120.220

Cylinder Head

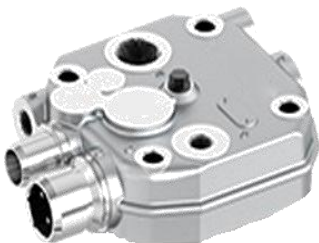

OEM Ref.

120.250

Plate



OEM Ref.

120.300

Full Repair Kit

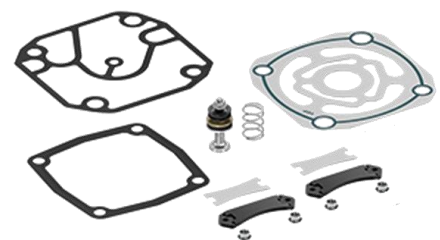

OEM Ref.

120.310 **Repair Kit**

OEM Ref.

120.320 **Valve Kit**

OEM Ref.

120.350 **Gasket Kit**

OEM Ref.

105.700 **Cylinder Liner Kit**

OEM Ref. 541 130 01 08 2,50*2,50*4,00

105.710 **Cylinder Liner Kit**

OEM Ref. 2,50*2,50*4,00

105.720 **Cylinder Liner**

OEM Ref.

105.500 **∅ 100,00 mm** **Piston**

105.510 **∅ 100,25mm**

105.520 **∅ 100,50mm**

OEM Ref. 2,50*2,50*4,00

105.550 **∅ 100,00 mm Piston & Ring**

105.560 **∅ 100,25mm**

105.570 **∅ 100,50mm**

OEM Ref. 2,50*2,50*4,00

105.600 **∅ 100,00 mm** **Ring**

105.610 **∅ 100,25mm**

105.620 **∅ 100,50mm**

OEM Ref. 2,50*2,50*4,00

105.580 **∅ 100,25mm**

105.585 **∅ 100,25mm**

105.590 **∅ 100,50mm**

OEM Ref. 541 131 02 07
541 130 02 17 / 541 131 02 07
2,50*2,50*3,00

117.410 **Valve Kit**

OEM Ref.

105.450 **Connecting Rod**

OEM Ref. 541 131 06 17
541 131 02 17

105.820 **Gear**

OEM Ref. 442 130 03 20
541 130 02 30 / 541 130 06 30

105.830 **Crankshaft Flange**

OEM Ref. 541 131 02 42

ASEL CODE

121.100

OEM Reference

457 130 20 15 / 457 130 15 15 / 911 553 001 0 / 911 553 003 0

**Kullanılan Araç
Vehicle Application**

AXOR / OM 457

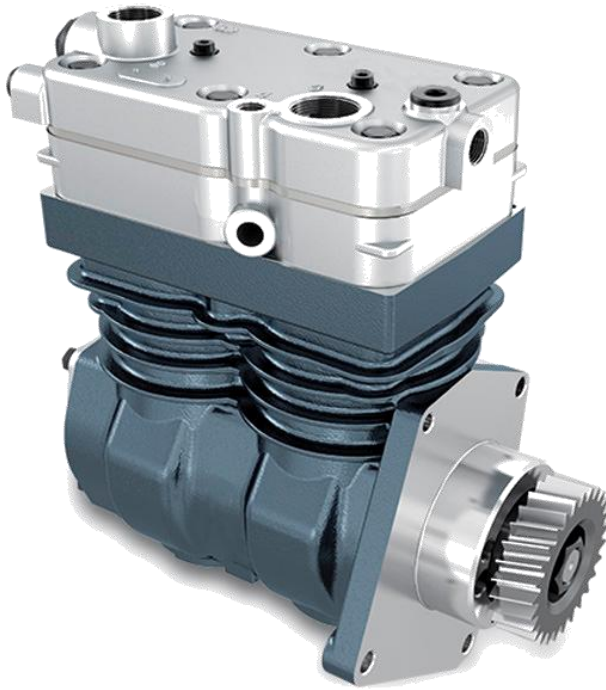

Technical Data

Cylinder Bore	Ø 85.00 mm
Swept Volume	636 cc
Stroke	56 mm

121.200

Complete Cylinder Head

121.210

Cylinder Head

121.250

Plate

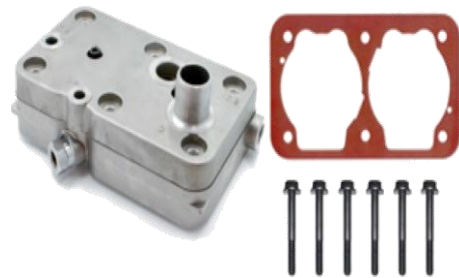

OEM Ref. 911 553 920 2 / 911 553 921 2 / 911 553 656 2

OEM Ref.

OEM Ref.

121.300

Full Repair Kit

121.320

Repair Kit

121.350

Gasket Kit

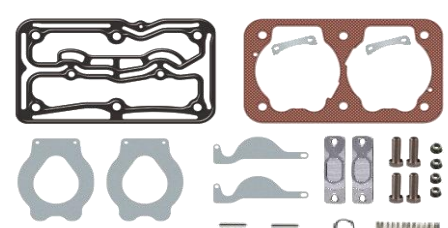
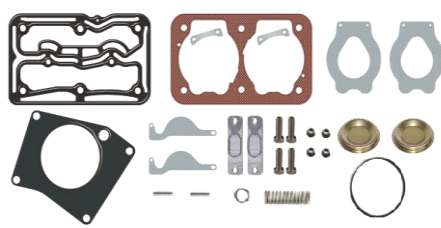
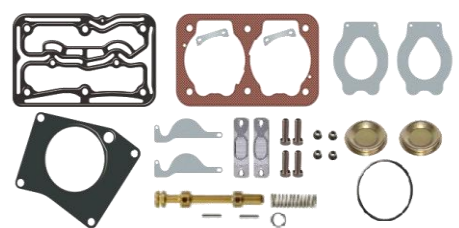

OEM Ref.

OEM Ref.

OEM Ref. 911 553 000 2

121.350 Gasket Kit

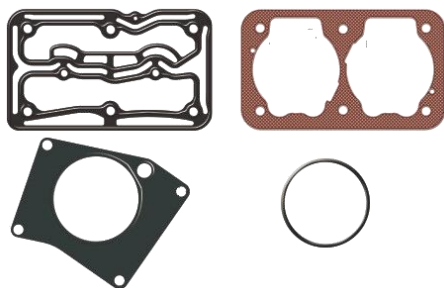

OEM Ref.

121.150 Crankcase



OEM Ref.

118.450 Connecting Rod



OEM Ref 000 131 24 17 / 911 145 737 2
3357219 / 2VF145041

121.400 Valve Kit



OEM Ref.

104.410 Valve Kit



OEM Ref.

121.750 Bushing



OEM Ref.

101.500 Ø 85,00 mm Piston

101.510 Ø 85,25 mm

101.520 Ø 85,50 mm



OEM Ref.

101.550 Ø 85,00 mm Piston & Ring

101.560 Ø 85,25 mm

101.570 Ø 85,50 mm



OEM Ref. 000 130 34 17 / 000 130 53 17
911 501 624 2 / 911 501 625 2

101.600 Ø 85,00 mm Ring

101.610 Ø 85,25 mm

101.620 Ø 85,50 mm



OEM Ref. 001 131 11 11
911 501 920 2

121.800 Crankshaft



OEM Ref. 911 553 694 4

118.820 Gear



OEM Ref. 457 132 00 05
895 905 210 4

101.830 Crankshaft Flange



OEM Ref. 000 131 29 32
411 147 603 4

ASEL CODE

122.100

OEM Reference

412 352 001 0 / 412 352 002 0 / 906 130 13 15 / 906 130 14 15 / 906 130 43 15

**Kullanılan Araç
Vehicle Application**

ATEGO / OM 904 LA / OM 906 LA / OM 924 LA



Technical Data

Cylinder Bore	Ø 85.00 mm
Swept Volume	352 cc
Stroke	62 mm

122.200

Complete Cylinder Head

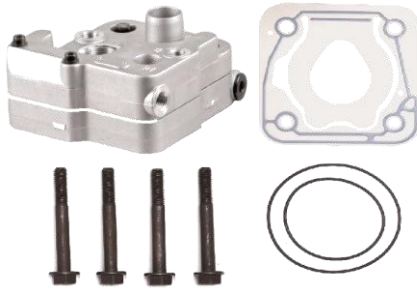

OEM Ref. 412 352 801 2
000 131 54 19

122.210

Cylinder Head



OEM Ref

122.250

Plate



OEM Ref.

122.300

Full Repair Kit

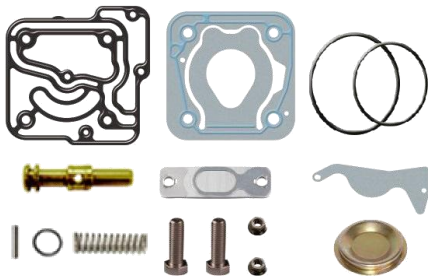

OEM Ref.

122.320

Repair Kit

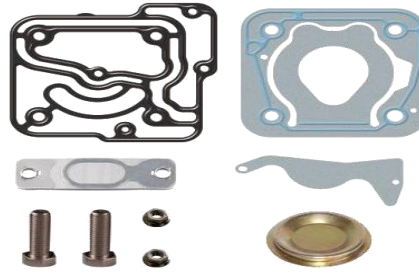

OEM Ref.

122.350

Gasket Kit

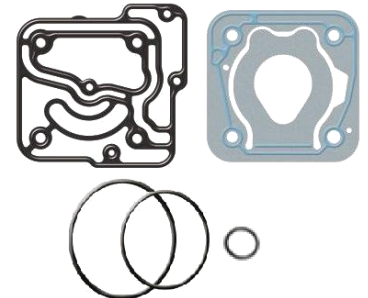

OEM Ref.

103.150

Crankcase



OEM Ref. 411 154 012 6 / 412 352 016 2

101.400

Valve Kit



OEM Ref.

101.410

Valve Kit



OEM Ref. 000 131 27 17
411 151 732 2 / 51.54106 6032

103.750

Connecting Rod

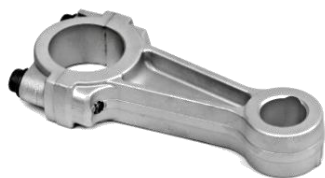

OEM Ref. 000 131 27 17
411 151 732 2 / 51.54106 6032

122.800

Crankshaft



OEM Ref.

103.820

Gear



OEM Ref. 895 905 169 4 / 906 132 03 05

101.500

Ø 85,00 mm

Piston

101.510

Ø 85,25 mm

101.520

Ø 85,50 mm



OEM Ref.

101.550

Ø 85,00 mm

Piston & Ring

101.560

Ø 85,25 mm

101.570

Ø 85,50 mm



OEM Ref. 0697442 / 1698686 / 128371
000 130 34 17 / 911 501 624 2 / 911 501 625 2

101.600

Ø 85,00 mm

Ring

101.610

Ø 85,25 mm

101.620

Ø 85,50 mm



OEM Ref. 3094621
911 501 920 2

101.830

Crankshaft Flange



OEM Ref. 000 131 29 32
411 147 603 4

401.830

ASEL CODE

123.100

OEM Reference

906 130 46 15 / 906 130 25 15 / 906 130 16 15 / 912 510 000 0 / 912 510 001 0

**Kullanılan Araç
Vehicle Application**

AXOR / TOURINO / CITARO / INTOURO / OM 906 LA / OM906 HLA / OM 926 LA



Technical Data

Cylinder Bore	Ø 85.00 mm
Swept Volume	636 cc
Stroke	56 mm

123.200

Complete Cylinder Head



OEM Ref. 912 510 922 2
001 130 37 15

123.210

Cylinder Head



OEM Ref

123.250

Plate



OEM Ref.

123.270

Cooling Plate



OEM Ref.

123.300

Full Repair Kit

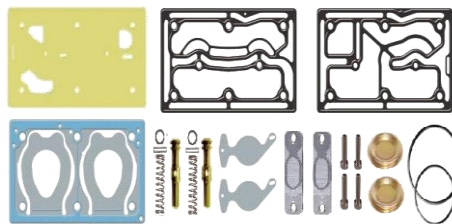

OEM Ref.

123.310

Repair Kit

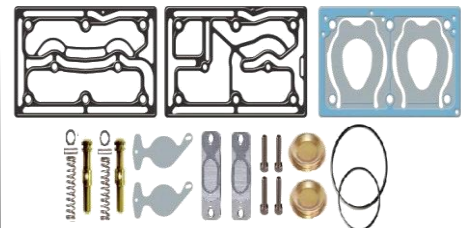

OEM Ref.

123.320 Repair Kit

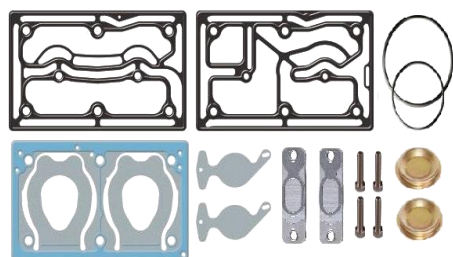

OEM Ref.

123.350 Gasket Kit

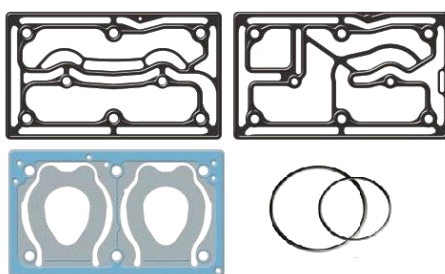

OEM Ref.

123.150 Crankcase



OEM Ref.

102.400 Valve Kit

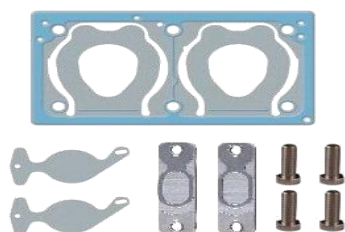

OEM Ref. 912 518 923 2

102.410 Valve Kit



OEM Ref.

118.450 Connecting Rod



OEM Ref. 000 131 24 17
911 145 7372 / 3357219

101.500 Ø 85,00 mm Piston



OEM Ref.

101.550 Ø 85,00 mm Piston & Ring



OEM Ref. 000 130 34 17 / 000 130 53 17
911 501 624 2 / 911 501 625 2

101.600 Ø 85,00 mm Ring



OEM Ref. 001 131 11 11
911 501 920 2

101.510 Ø 85,25 mm

101.560 Ø 85,25 mm

101.610 Ø 85,25 mm

101.520 Ø 85,50 mm

101.570 Ø 85,50 mm

101.620 Ø 85,50 mm

123.800 Crankshaft



OEM Ref. 000 131 78 16
412 636 691 4

103.820 Gear



OEM Ref. 906 132 03 05
895 905 169 4

101.830 Crankshaft Flange



OEM Ref. 000 131 29 32
411 147 603 4

ASEL CODE

124.100

OEM Reference

471 130 24 15 / 471 130 60 15 / 471 130 37 15 / 471 130 19 15 / 001 130 55 15 / 001 130 82 15 / LK4972 / K051975N01 / K066254N00 / K066254N01

**Kullanılan Araç
Vehicle Application**

AROCS EURO 6 / OM 471 LA / OM 473 LA

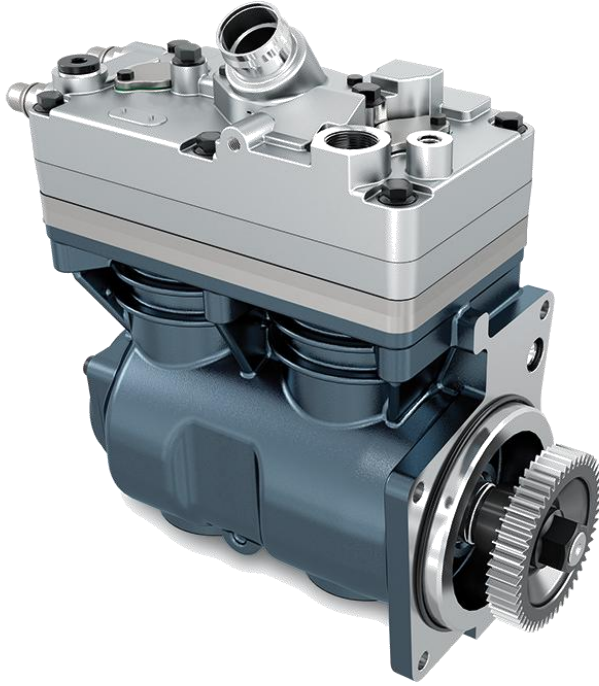

Technical Data

Cylinder Bore	Ø 86.00 mm
Swept Volume	650 cc
Stroke	56 mm

124.200

Complete Cylinder Head

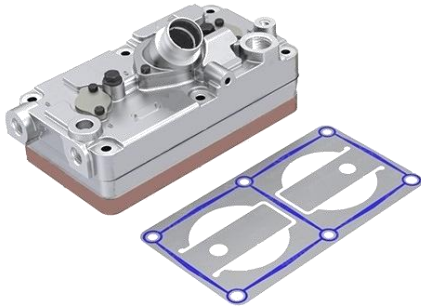

OEM Ref. K091889K50 / K091890K50

124.210

Cylinder Head



OEM Ref K032186

124.250

Plate

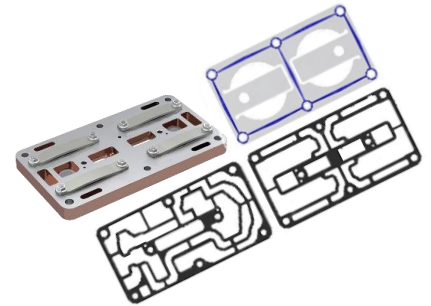

OEM Ref. K091891K50

124.270

Cooling Plate



OEM Ref.

124.300

Full Repair Kit

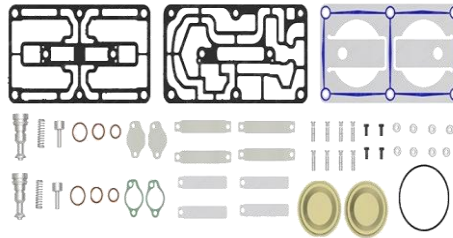

OEM Ref.

124.310

Repair Kit

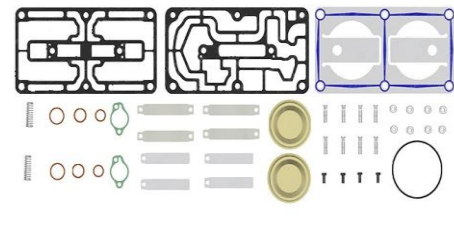

OEM Ref.

124.320

Repair Kit

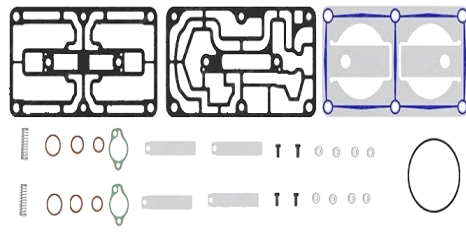

OEM Ref.

124.350

Gasket Kit

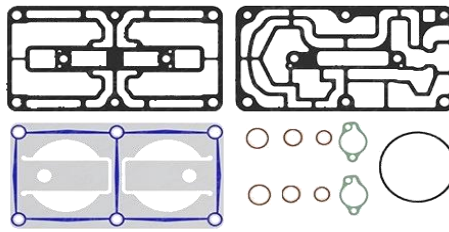

OEM Ref.

124.150

Crankcase



OEM Ref.

124.400

Valve Kit

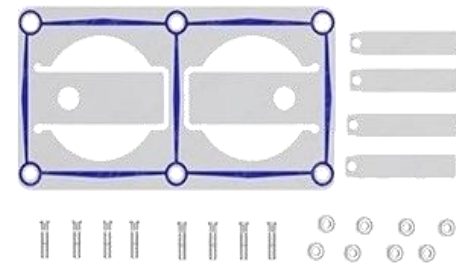

OEM Ref.

124.410

Valve Kit

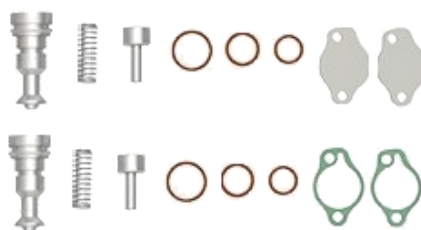

OEM Ref.

124.450

Connecting Rod



OEM Ref.

124.500

Ø 86,00 mm

Piston



OEM Ref.

124.550

Ø 86,00 mm

Piston & Ring



OEM Ref. SEB22547 / SEB22548 / 42549147

124.600

Ø 86,00 mm

Ring



OEM Ref.

124.510

Ø 86,25 mm

124.560

Ø 86,25 mm

124.610

Ø 86,25 mm

124.520

Ø 86,50 mm

124.570

Ø 86,50 mm

124.620

Ø 86,50 mm

124.800

Crankshaft



OEM Ref.

124.820

Gear



OEM Ref. 472 132 03 05

124.830

Crankshaft Flange



OEM Ref.

ASEL CODE	125.100
OEM Reference	407 130 01 15 / 407 130 15 15
Kullanılan Araç Vehicle Application	MB 407

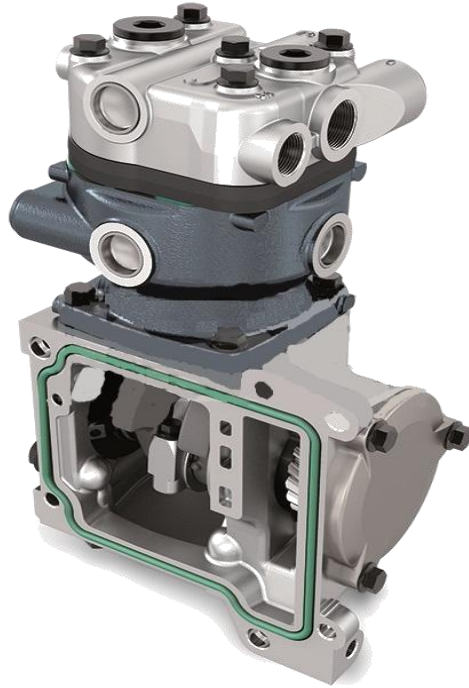

Technical Data	
Cylinder Bore	Ø 90.00 mm
Swept Volume	292 cc
Stroke	46 mm

125.200 Complete Cylinder Head

OEM Ref. 411 033 801 2 / 411 033 806 2 / 411 033 808 2

125.210 Cylinder Head

OEM Ref 411 033 653 2

125.250 Plate

OEM Ref. 411 033 503 2 / 411 033 505 2
81 54124 6013

125.300 Full Repair Kit

OEM Ref.

125.320 Repair Kit

OEM Ref.

125.350 Gasket Kit

OEM Ref.

108.150

Crankcase

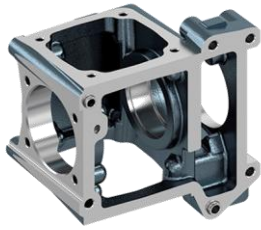

OEM Ref. 447 131 03 15

110.400

Valve Kit

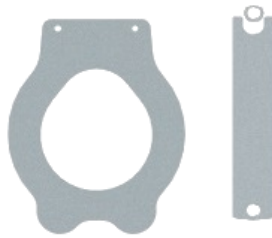

OEM Ref.

110.450

Connecting Rod



OEM Ref. 403 130 36 16 / 403 130 22 16

113.700

Cylinder Liner Kit



OEM Ref. 402 130 06 08 / 402 130 02 08 / 427 130 00 08
402 131 05 02

113.720

Cylinder Liner



OEM Ref. STW63740 / 402 130 03 08

110.775

Connecting Rod Bearing Kit



OEM Ref. 403 131 02 33

110.500

Ø 90,00 mm

Piston

110.510

Ø 90,25mm

110.520

Ø 90,50mm



OEM Ref. 403 130 05 17

110.550

Ø 90,00 mm

Piston & Ring

110.560

Ø 90,25mm

110.570

Ø 90,50mm



OEM Ref.

106.600

Ø 90,00 mm

Ring

106.610

Ø 90,25mm

106.620

Ø 90,50mm



OEM Ref.

110.800

Crankshaft



OEM Ref. 403 131 07 16

110.820

Gear



OEM Ref. 466 132 00 05

110.830

Crankshaft Flange



OEM Ref. 403 130 16 45 / 403 130 06 45 / 403 130 08 45

ASEL CODE	128.100
OEM Reference	472 130 05 15 / 472 130 11 15 / 001 130 72 15 / K034655 / K035912X / K035912 / BA921
Kullanılan Araç Vehicle Application	OM 472 / DD15

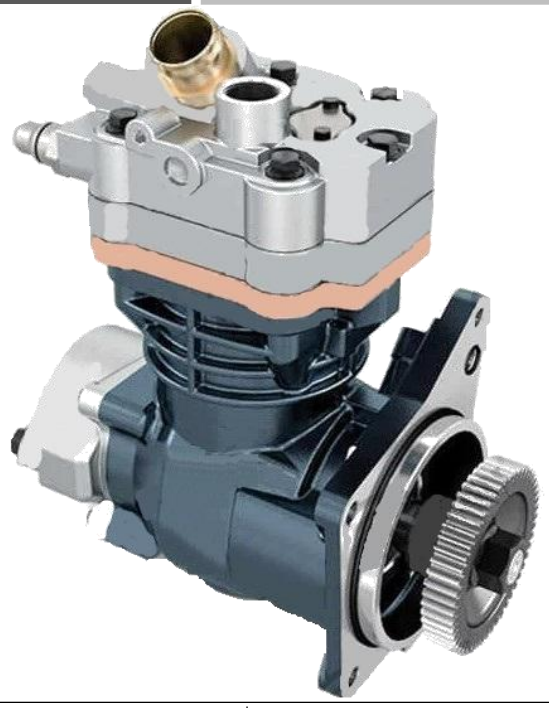

Technical Data	
Cylinder Bore	Ø 90.00 mm
Swept Volume	360 cc
Stroke	54 mm

128.200 Complete Cylinder Head



OEM Ref.

128.210 Cylinder Head



OEM Ref.

128.250 Plate

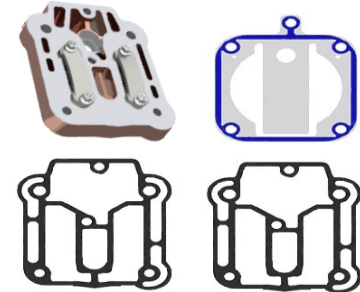

OEM Ref.

128.270 Cooling Plate



OEM Ref.

128.300 Full Repair Kit

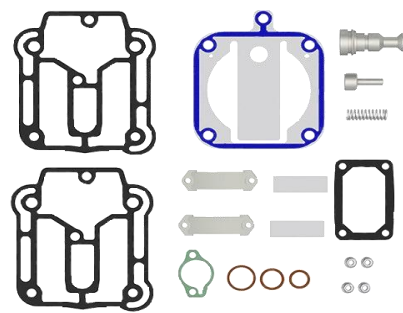

OEM Ref.

128.310 Repair Kit

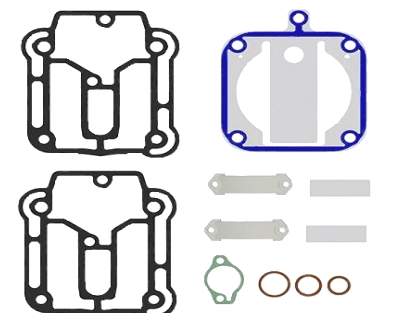

OEM Ref.

128.320 Repair Kit

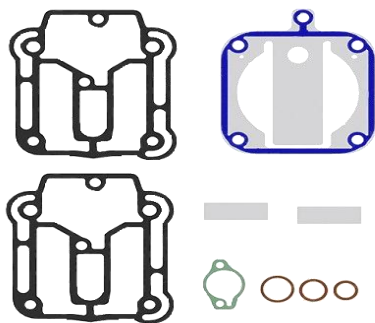

OEM Ref.

128.350 Gasket Kit

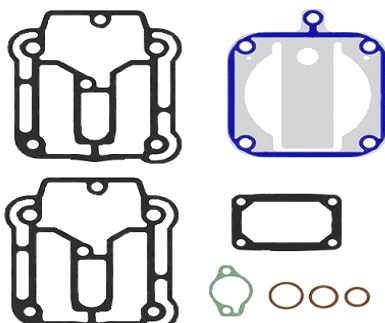

OEM Ref.

128.150 Crankcase



OEM Ref.

128.400 Valve Kit

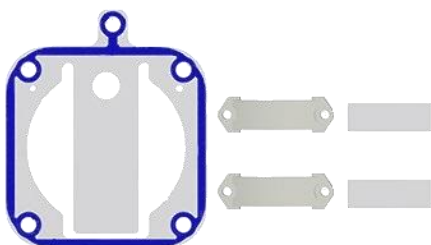

OEM Ref.

128.410 Valve Kit



OEM Ref.

214.450 Connecting Rod



OEM Ref. SEB22464 / EB02800

214.500 Ø 92,00 mm Piston



OEM Ref.

214.550 Ø 92,00 mm Piston & Ring



OEM Ref. 51.54119-6008 / 51.54119-6009
K006026 / K012079 / K012079K56 / SEB22530

214.510 Ø 92,25mm

214.560 Ø 92,25mm

214.520 Ø 92,50mm

214.570 Ø 92,50mm

214.600 Ø 92,00 mm Ring



OEM Ref.

214.610 Ø 92,25mm

214.620 Ø 92,50mm

128.800 Crankshaft



OEM Ref.

124.820 Gear



OEM Ref. 472 132 03 05

128.830 Crankshaft Flange



OEM Ref.

ASEL CODE

129.100

OEM Reference

LP490 TYPE / 14900022112 / 14900085312 / 457 130 54 15 / 457 130 62 15

**Kullanılan Araç
Vehicle Application**

AXOR / OM 457 / EURO 5



Technical Data

Cylinder Bore	Ø 92 / Ø 60 mm
Swept Volume	490 cc
Stroke	60 / 30 mm

129.200

Complete Cylinder Head

129.210

Cylinder Head

129.250

Plate

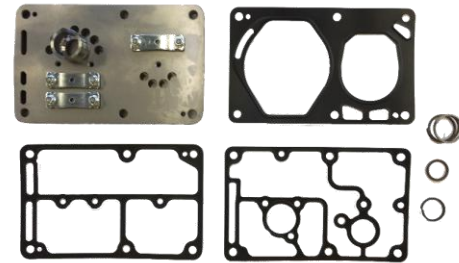
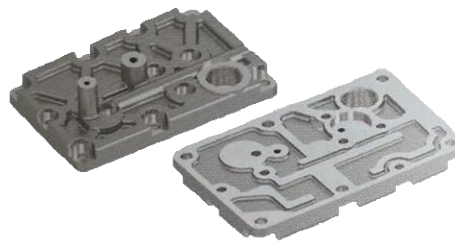

OEM Ref.

OEM Ref.

OEM Ref.

129.270

Cooling Plate

129.300

Full Repair Kit

129.320

Repair Kit

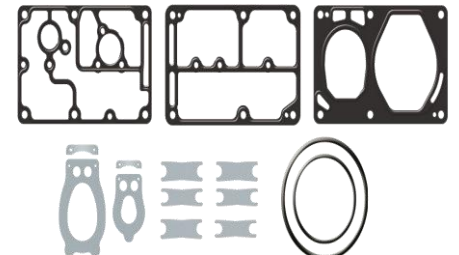
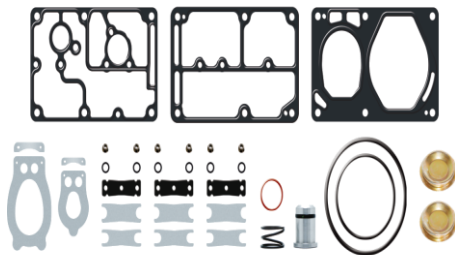
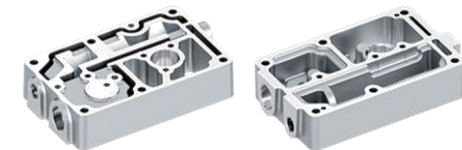

OEM Ref.

OEM Ref.

OEM Ref.

129.350 **Gasket Kit**

OEM Ref.

129.400 **Valve Kit**

OEM Ref.

129.150 **Crankcase**

OEM Ref.

129.450 **Connecting Rod**

OEM Ref.

129.460 **Connecting Rod**

OEM Ref.

129.800 **Crankshaft**

OEM Ref.

129.820 **Gear**

OEM Ref.

129.830 **Crankshaft Flange**

OEM Ref.

129.500 **Ø 92,00 mm Piston**

129.510 **Ø 92,25 mm**

129.520 **Ø 92,50 mm**

OEM Ref. 149000305
2,50*2,50*3,00

129.550 **Ø 92,00 mm Piston & Ring**

129.560 **Ø 92,25 mm**

129.570 **Ø 92,50 mm**

OEM Ref. 2,50*2,50*3,00

129.600 **Ø 92,00 mm Ring**

129.610 **Ø 92,25 mm**

129.620 **Ø 92,50 mm**

OEM Ref. 2,50*2,50*3,00

129.700 **Cylinder Liner Kit**

OEM Ref. 2,50*2,50*3,00

129.720 **Cylinder Liner**

OEM Ref.

129.505 **Ø 60,00 mm**

129.515 **Ø 60,25 mm**

129.525 **Ø 60,50 mm**

OEM Ref. 14900025920
2,00*2,00*3,00

129.555 **Ø 60,00 mm**

129.565 **Ø 60,25 mm**

129.575 **Ø 60,50 mm**

OEM Ref. 2,00*2,00*3,00

129.605 **Ø 60,00 mm**

129.615 **Ø 60,25 mm**

129.625 **Ø 60,50 mm**

OEM Ref. 2,00*2,00*3,00

129.705 **Cylinder Liner Kit**

OEM Ref. 2,00*2,00*3,00

129.725 **Cylinder Liner**

OEM Ref.

ASEL CODE

130.100

OEM Reference

LP490 / 470 130 22 15 / 470 130 12 15 / 470 130 16 15

**Kullanılan Araç
Vehicle Application**

OM 470 SERIES / EURO 6 SERIES / TOURISMO SERIES / TRAVEGO SERIES

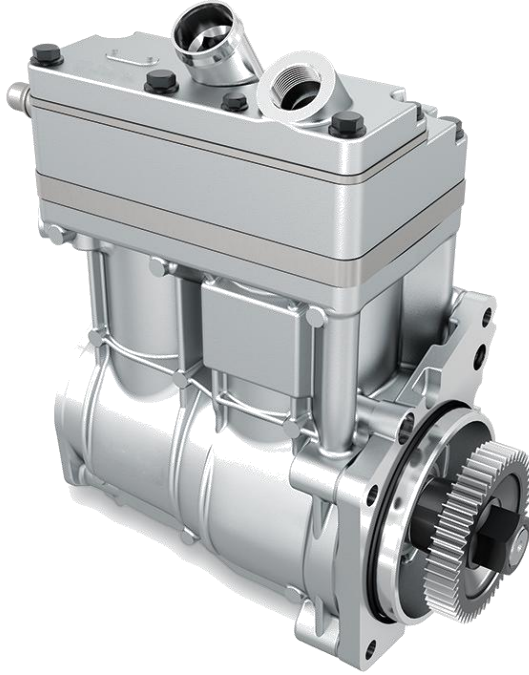

Technical Data

Cylinder Bore	Ø 92 / Ø 60 mm
Swept Volume	490 cc
Stroke	60 / 30 mm

130.200

Complete Cylinder Head

130.210

Cylinder Head

130.250

Plate

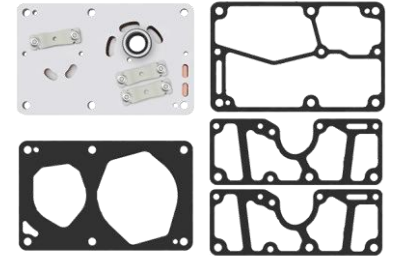
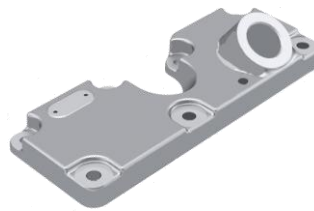

OEM Ref.

OEM Ref.

OEM Ref. 001 130 88 15

130.270

Cooling Plate

130.300

Full Repair Kit

130.320

Repair Kit

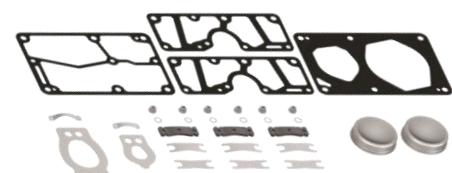
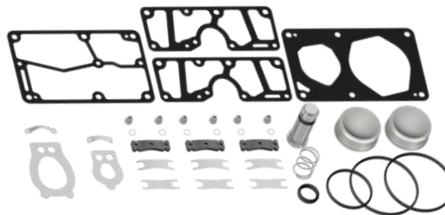

OEM Ref.

OEM Ref.

OEM Ref.

130.350 **Gasket Kit**

OEM Ref.

129.400 **Valve Kit**

OEM Ref.

130.150 **Crankcase**

OEM Ref.

129.450 **Connecting Rod**

OEM Ref.

129.460 **Connecting Rod**

OEM Ref.

130.800 **Crankshaft**

OEM Ref.

130.820 **Gear**

OEM Ref. 470 132 01 05

130.830 **Crankshaft Flange**

OEM Ref.

129.500 **Ø 92,00 mm Piston**

129.510 **Ø 92,25 mm**

129.520 **Ø 92,50 mm**

OEM Ref. 149000305
2,50*2,50*3,00

129.550 **Ø 92,00 mm Piston & Ring**

129.560 **Ø 92,25 mm**

129.570 **Ø 92,50 mm**

OEM Ref. 2,50*2,50*3,00

129.600 **Ø 92,00 mm Ring**

129.610 **Ø 92,25 mm**

129.620 **Ø 92,50 mm**

OEM Ref. 2,50*2,50*3,00

130.700 **Cylinder Liner Kit**

OEM Ref. 2,50*2,50*3,00

130.720 **Cylinder Liner**

129.505 **Ø 60,00 mm**

129.515 **Ø 60,25 mm**

129.525 **Ø 60,50 mm**

OEM Ref. 14900025920
2,00*2,00*3,00

129.555 **Ø 60,00 mm**

129.565 **Ø 60,25 mm**

129.575 **Ø 60,50 mm**

OEM Ref. 2,00*2,00*3,00

129.605 **Ø 60,00 mm**

129.615 **Ø 60,25 mm**

129.625 **Ø 60,50 mm**

OEM Ref. 2,00*2,00*3,00

130.705 **Cylinder Liner Kit**

OEM Ref. 2,00*2,00*3,00

130.725 **Cylinder Liner**

ASEL CODE

130.110

OEM Reference

LP490 / 471 130 32 15 / 471 130 34 15 / 471 130 40 15 / 471 130 42 15 / 001 130 64 15

**Kullanılan Araç
Vehicle Application**

ACTROS EURO 6 / OM471 LA / OM473 LA



Technical Data

Cylinder Bore	Ø 92 / Ø 60 mm
Swept Volume	490 cc
Stroke	60 / 30 mm

130.200

Complete Cylinder Head



OEM Ref.

130.210

Cylinder Head

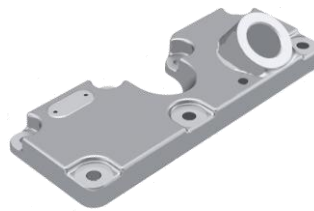

OEM Ref.

130.250

Plate

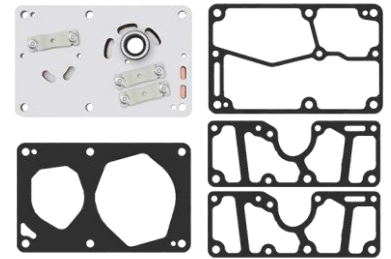

OEM Ref. 001 130 88 15

130.270

Cooling Plate



OEM Ref.

130.300

Full Repair Kit

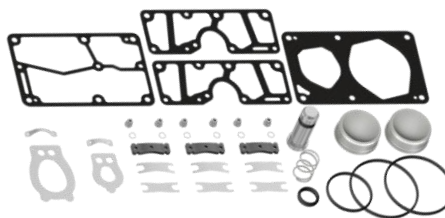

OEM Ref.

130.320

Repair Kit

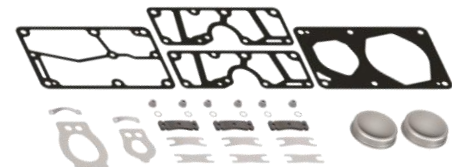

OEM Ref.

130.350 **Gasket Kit**

OEM Ref.

129.400 **Valve Kit**

OEM Ref.

130.150 **Crankcase**

OEM Ref.

129.450 **Connecting Rod**

OEM Ref.

129.460 **Connecting Rod**

OEM Ref.

130.805 **Crankshaft**

OEM Ref.

124.820 **Gear**

OEM Ref. 472 132 03 05

130.830 **Crankshaft Flange**

OEM Ref.

129.500 **Ø 92,00 mm Piston**

129.510 **Ø 92,25 mm**

129.520 **Ø 92,50 mm**

OEM Ref. 149000305
2,50*2,50*3,00

129.550 **Ø 92,00 mm Piston & Ring**

129.560 **Ø 92,25 mm**

129.570 **Ø 92,50 mm**

OEM Ref. 2,50*2,50*3,00

129.600 **Ø 92,00 mm Ring**

129.610 **Ø 92,25 mm**

129.620 **Ø 92,50 mm**

OEM Ref. 2,50*2,50*3,00

130.700 **Cylinder Liner Kit**

OEM Ref. 2,50*2,50*3,00

130.720 **Cylinder Liner**

129.505 **Ø 60,00 mm**

129.515 **Ø 60,25 mm**

129.525 **Ø 60,50 mm**

OEM Ref. 14900025920
2,00*2,00*3,00

129.555 **Ø 60,00 mm**

129.565 **Ø 60,25 mm**

129.575 **Ø 60,50 mm**

OEM Ref. 2,00*2,00*3,00

129.605 **Ø 60,00 mm**

129.615 **Ø 60,25 mm**

129.625 **Ø 60,50 mm**

OEM Ref. 2,00*2,00*3,00

130.705 **Cylinder Liner Kit**

OEM Ref. 2,00*2,00*3,00

130.725 **Cylinder Liner**

ASEL CODE

131.100

OEM Reference

906 130 45 15 / 906 130 32 15 / 906 130 09 15 / 412 636 000 0 / 412 636 003 0

**Kullanılan Araç
Vehicle Application**

EVOBUS / CITARO SERIES



Technical Data

Cylinder Bore	Ø 85.00 mm
Swept Volume	636 cc
Stroke	56 mm

131.200

Complete Cylinder Head



OEM Ref. 000 131 55 19 / 412 636 001 2

121.210

Cylinder Head



OEM Ref.

131.250

Plate



OEM Ref.

131.300

Full Repair Kit

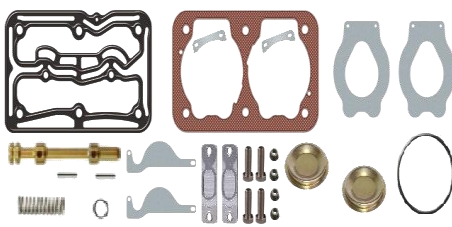

OEM Ref.

131.310

Repair Kit

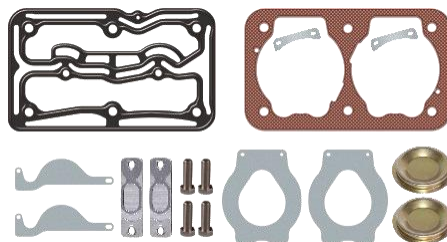

OEM Ref.

121.320

Repair Kit

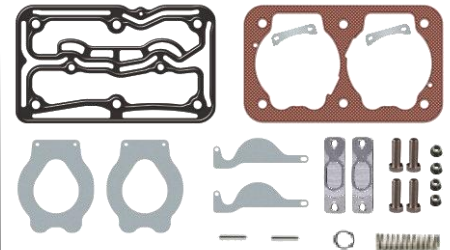

OEM Ref.

121.350

Gasket Kit

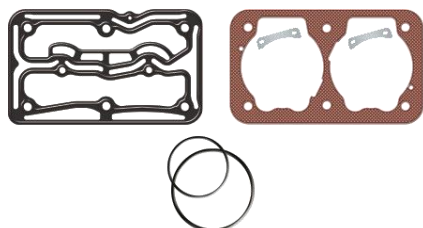

OEM Ref.

131.150

Crankcase



OEM Ref.

118.450

Connecting Rod



OEM Ref 000 131 24 17 / 911 145 737 2
3357219 / 2VF145041

121.400

Valve Kit



OEM Ref.

104.410

Valve Kit



OEM Ref.

103.760

Bushing



OEM Ref. 000 131 44 50
411 151 340 4

101.500

Ø 85,00 mm

Piston

101.510

Ø 85,25 mm

101.520

Ø 85,50 mm



OEM Ref.

101.550

Ø 85,00 mm

Piston & Ring

101.560

Ø 85,25 mm

101.570

Ø 85,50 mm



OEM Ref. 000 130 34 17 / 000 130 53 17
911 501 624 2 / 911 501 625 2

101.600

Ø 85,00 mm

Ring

101.610

Ø 85,25 mm

101.620

Ø 85,50 mm



OEM Ref. 001 131 11 11
911 501 920 2

123.800

Crankshaft



OEM Ref. 000 131 78 16
412 636 691 4

103.820

Gear



OEM Ref. 906 132 03 05
895 905 169 4

101.830

Crankshaft Flange



OEM Ref. 000 131 29 32
411 147 603 4

ASEL CODE

132.100

OEM Reference

412 636 001 0

**Kullanılan Araç
Vehicle Application**

EOBUS / CITARO / O530G / O530L / AXOR



Technical Data

Cylinder Bore	Ø 85.00 mm
Swept Volume	636 cc
Stroke	56 mm

132.200

Complete Cylinder Head

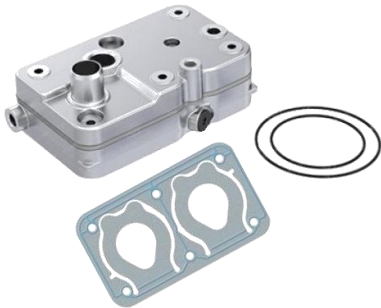

OEM Ref. 001 131 56 19
412 636 920 2

132.210

Cylinder Head



OEM Ref.

132.250

Plate



OEM Ref.

132.270

Cooling Plate



OEM Ref.

132.300

Full Repair Kit



OEM Ref.

132.310

Repair Kit

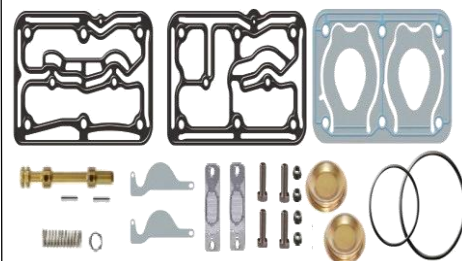

OEM Ref.

132.320 Repair Kit

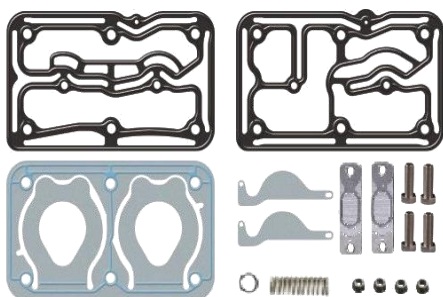

OEM Ref.

132.350 Gasket Kit

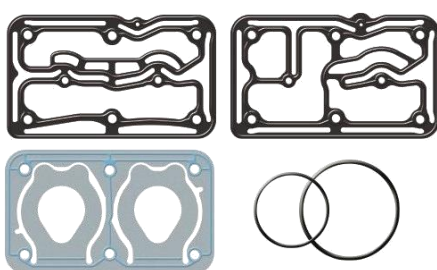

OEM Ref.

118.450 Connecting Rod



OEM Ref 000 131 24 17 / 911 145 737 2
3357219 / 2VF145041

104.400 Valve Kit

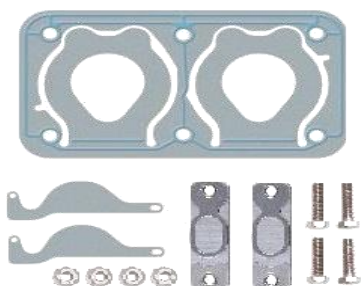

OEM Ref.

104.410 Valve Kit



OEM Ref.

132.150 Crankcase



OEM Ref.

101.500 Ø 85,00 mm Piston

101.510 Ø 85,25 mm

101.520 Ø 85,50 mm



OEM Ref.

101.550 Ø 85,00 mm Piston & Ring

101.560 Ø 85,25 mm

101.570 Ø 85,50 mm



OEM Ref. 000 130 34 17 / 000 130 53 17
911 501 624 2 / 911 501 625 2

101.600 Ø 85,00 mm Ring

101.610 Ø 85,25 mm

101.620 Ø 85,50 mm



OEM Ref. 001 131 11 11
911 501 920 2

123.800 Crankshaft



OEM Ref. 000 131 78 16
412 636 691 4

103.820 Gear



OEM Ref. 906 132 03 05
895 905 169 4

101.830 Crankshaft Flange



OEM Ref. 000 131 29 32
411 147 603 4



KOMPRESOR YEDEK PARÇALARI
COMPRESSOR SPARE PARTS

İÇİNDEKİLER / INDEX

Sayfa No / Page No

MAN

FE SERIES / D 2866 / D2876 ENGINE / 19.464	63-64
LIONS / CENTROLINER / CNG ENGINE BUS / G2866 / DUH 01 – 05 / LUH 01 - 04 / UH / UM	65-66
D2866 / TGA 18 T – 26 T / 33.840 – 33.360	67-68
TGA / F2000 / 19.422	69-70
TGA SERIES	71-72
TGA SERIES	73-74
TGA SERIES	75-76
MAN	77
MAN	78
LE SERIES / TGL / TGM / D0834 / D0836 ENGINE	79
TGL / TGM / D0834 ENGINE	80
19.260 / 19.360 / 19.361 / 1919 / 1922	81-82
1919 / 1922	83-84
F2000 – NEOPLAN / 19.422 – 19.423 / 26.281	85-86
LIONS SERIES / TOURLINER / D2866 / D2876 ENGINE	87-88
19.260 / 19.360 / 19.361 / 1919 / 1922	89-90
1919 / 1922	91-92
26.320 / 26.270	93-94
M 2000 / L 2000 / BUS / G90 / M90	95-96
26.320 / L 2000 / M 2000 / BUS / G90	97-98
TGL / TGM	99-100
32.370/ 32.370 HX/ D0834LFL/ D0834LOH D0836LFL / D0836LOH / D0836LFG	101-102
32.270 / TGA / 41 430 - 460 – 400 / TGX / TGS / FORTUNA BUS / D2066 ENGINE / NEOPLAN BUS	
STARLINER / CITYLINER / TOURLINER / SKYLINER / LIONS COACH / LIONS REGIO / LIONS CITY	103-104
TGA / TGX / TGS / NEOPLAN BUS / STARLINER / CITYLINER	
LIONS / LIONS COACH / LIONS REGIO / LIONS CITY	105-106
TGA / TGX / TGS / NEOPLAN BUS / STARLINER / CITYLINER / LIONS	107-108
TGA / TGX / TGS / NEOPLAN BUS / STARLINER / CITYLINER / LIONS	109-110
16.260 / 19.360 / 19.361	111-112
3205 / 32053 / 32054 / 4234 / 4230 / 4230-01 / MM3D245.9 / ЯМ3-236 , 238 , 7601 , 7051	113-114
M 2000	115-116
MAN	117-118
OPTARE / ALERO	119-120
TCV BUS / 18.220	121-122
M 2000 / L 2000 / BUS	123-124
TGA / TGX / TGS / TGM / D2066 ENGINE / CENTROLINER / CITYLINER / TOURLINER	
LIONS COACH / LIONS CITY / LIONS REGIO	125-126
TGA / TGX / TGS / TGM / M2000 / CENTROLINER / CITYLINER / TOURLINER	
LIONS COACH / LIONS CITY / LIONS REGIO	127-128
LION S CITY / LION S REGIO / BUS / EURO 6	129-130

ASEL CODE	201.100
OEM Reference	51.54100-6011 / 51.54100-6013 / 51.54100-6015 51.54100-7025 / 51.54100-7177 / 51.54100-7179
Kullanılan Araç Vehicle Application	FE SERIES / D2866 / D2876 / 19.464

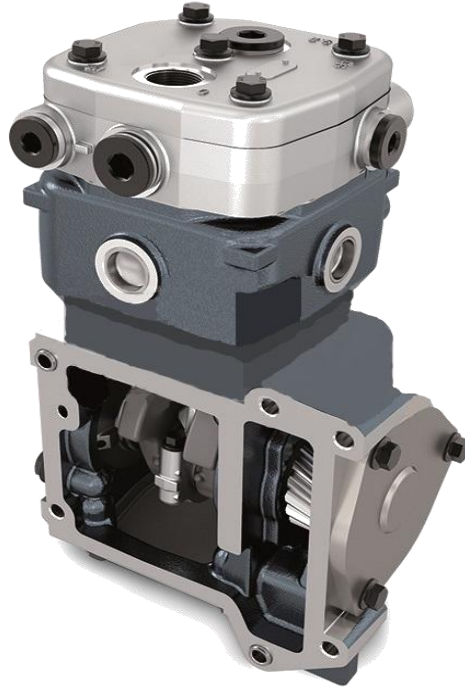

Technical Data	
Cylinder Bore	Ø 100.00 mm
Swept Volume	360 cc
Stroke	46 mm

201.200 Complete Cylinder Head

OEM Ref. 51 54114-6070 / 51 54114-6073 / 51 54114-6066
51 54114-6067 / 51 54114-6086
412 100 800 2 / 412 100 805 2 / 412 100 806 2

201.210 Cylinder Head

OEM Ref.

201.250 Plate

OEM Ref.

201.300 Full Repair Kit

OEM Ref.

201.350 Gasket Kit

OEM Ref.

201.400 Valve Kit

OEM Ref.

108.150

Crankcase

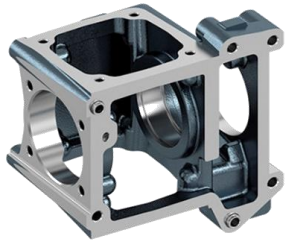

OEM Ref. 51.54112-0012

110.160

Cover



OEM Ref.

201.450

Connecting Rod



OEM Ref. 51.54106-6021

201.700

Cylinder Liner Kit



OEM Ref.

201.720

Cylinder Liner



OEM Ref. 51.54105-6016 / 51.54105-6021

110.750

Bushing



OEM Ref. 51.93020-1007

105.500

Ø 100,00 mm

Piston

105.550

Ø 100,00 mm Piston & Ring

105.600

Ø 100,00 mm

Ring

105.510

Ø 100,25mm

105.560

Ø 100,25mm

105.610

Ø 100,25mm

105.520

Ø 100,50mm

105.570

Ø 100,50mm

105.620

Ø 100,50mm



OEM Ref.

2,50*2,50*4,00



OEM Ref.

2,50*2,50*4,00



OEM Ref.

2,50*2,50*4,00

110.800

Crankshaft



OEM Ref. 403 131 07 16

110.820

Gear



OEM Ref. 466 132 00 05

110.830

Crankshaft Flange



OEM Ref. 403 130 16 45 / 403 130 06 45 / 403 130 08 45

ASEL CODE

202.100

OEM Reference

51.54100-6005 / 51.54100-6023 / 51.54100-7003
51.54100-7178 / 51.54100-9005 / 51.54100-9903

**Kullanılan Araç
Vehicle Application**

LIONS / CENTROLINER / CNG ENGINE BUS
G2866 / DUH 01 – 05 / LUH 01 – 04 / UH / UM

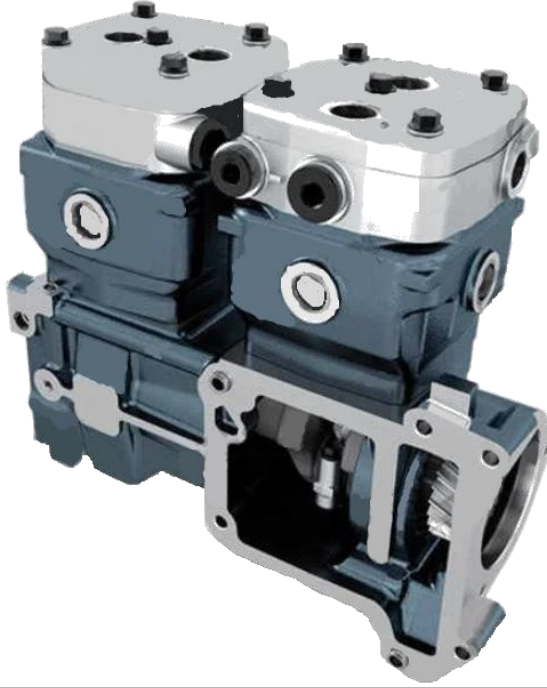

Technical Data

Cylinder Bore	Ø 100.00 mm
Swept Volume	720 cc
Stroke	46 mm

201.200

Complete Cylinder Head



OEM Ref. 51 54114-6070 / 51 54114-6073 / 51 54114-6066
51 54114-6067 / 51 54114-6086
412 100 800 2 / 412 100 805 2 / 412 100 806 2

201.210

Cylinder Head



OEM Ref

201.250

Plate



OEM Ref.

202.300

Full Repair Kit

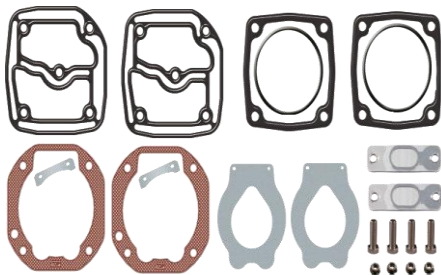

OEM Ref.

202.350

Gasket Kit

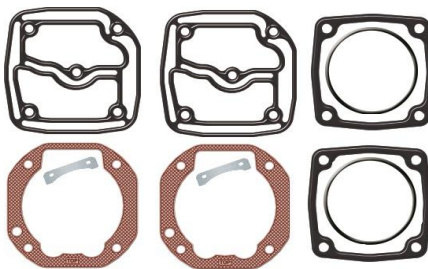

OEM Ref.

201.300

Full Repair Repair Kit

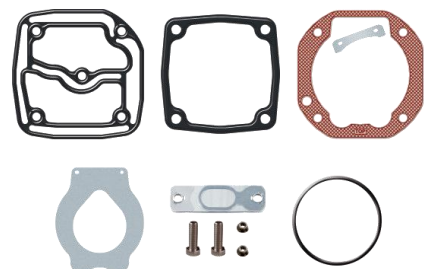

OEM Ref.

202.150 Crankcase



OEM Ref. 51.54112-6030 / 51.54112-6037

202.165 Cover



OEM Ref.

201.450 Connecting Rod



OEM Ref. 51.54106-6021

201.700 Cylinder Liner Kit



OEM Ref.

201.720 Cylinder Liner



OEM Ref. 51.54105-6016 / 51.54105-6021

202.750 Bushing



OEM Ref. 51.93020-0335

105.500 Ø 100,00 mm Piston

105.510 Ø 100,25mm

105.520 Ø 100,50mm



OEM Ref. 2,50*2,50*4,00

105.550 Ø 100,00 mm Piston & Ring

105.560 Ø 100,25mm

105.570 Ø 100,50mm



OEM Ref. 2,50*2,50*4,00

105.600 Ø 100,00 mm Ring

105.610 Ø 100,25mm

105.620 Ø 100,50mm



OEM Ref. 2,50*2,50*4,00

202.800 Crankshaft



OEM Ref. 51.54113-5044

202.820 Gear



OEM Ref. 51.54210-0182

202.760 Roller Bearing



OEM Ref. 51.93420-0016

ASEL CODE

203.100

OEM Reference

51.54100-7033 / 51.54100-7088

**Kullanılan Araç
Vehicle Application**

D2866 / TGA 18 T – 26 T / 33.480 – 33.360

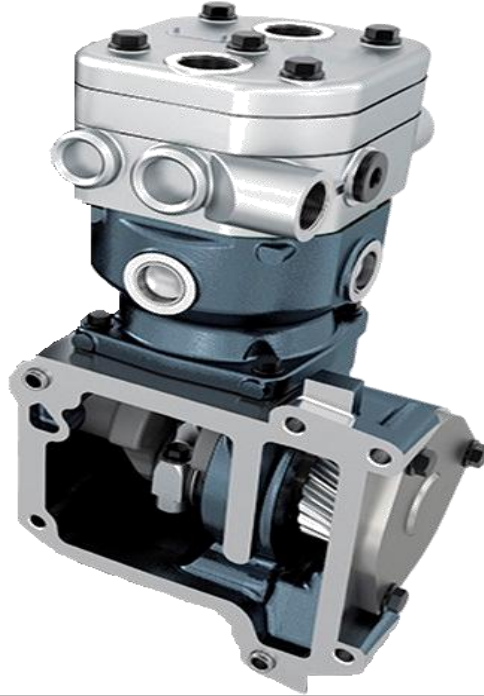

Technical Data

Cylinder Bore	Ø 90.00 mm
Swept Volume	292 cc
Stroke	46 mm

203.200

Complete Cylinder Head

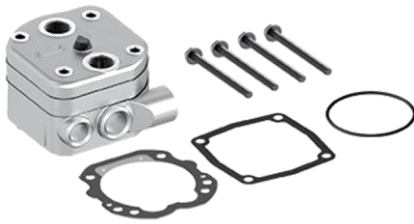

OEM Ref. 51.54114-6072 / 51.54114-6081
412.090.801.2 / 412.090.803.2 / 412.090.920.2

203.210

Cylinder Head



OEM Ref

203.250

Plate



OEM Ref.

203.270

Cooling Plate



OEM Ref.

203.300

Full Repair Kit

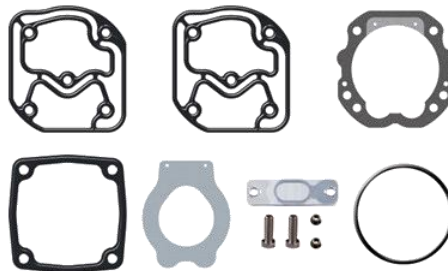

OEM Ref.

203.350

Gasket Kit

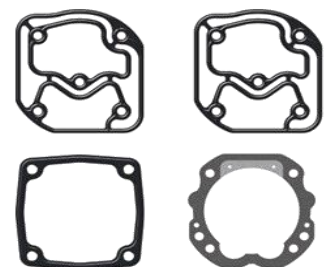

OEM Ref.

203.150 Crankcase

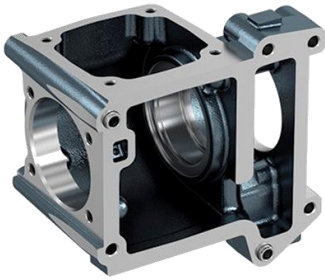

OEM Ref. 51.54112-0027 / 51.54112-0031

203.400 Valf Kit



OEM Ref.

110.450 Connecting Rod



OEM Ref. 51.54106-6013
403 130 22 16 / 403 130 36 16

113.700 Cylinder Liner Kit



OEM Ref. 402 130 06 08 / 402 130 02 08 / 427 130 00 08
402 131 05 02

113.720 Cylinder Liner



OEM Ref. STW63740 / 402 130 03 08

110.750 Bushing



OEM Ref. 51.93020-1007

110.500 Ø 90,00 mm Piston



OEM Ref. 403 130 05 17

110.550 Ø 90,00 mm Piston & Ring



OEM Ref.

106.600 Ø 90,00 mm Ring



OEM Ref. 51.02503-0562 / 51.02503-0772

110.510 Ø 90,25mm

110.560 Ø 90,25mm

106.610 Ø 90,25mm

110.520 Ø 90,50mm

110.570 Ø 90,50mm

106.620 Ø 90,50mm

110.800 Crankshaft



OEM Ref. 403 131 07 16

203.820 Gear



OEM Ref. 51.54210-0152

110.830 Crankshaft Flange



OEM Ref. 403 130 16 45 / 403 130 06 45 / 403 130 08 45

ASEL CODE

204.100

OEM Reference

51.54100-7028 / 51.54100-7130

**Kullanılan Araç
Vehicle Application**

TGA / F2000 – 19.422



Technical Data

Cylinder Bore	Ø 90.00 mm
Swept Volume	585 cc
Stroke	46 mm

203.200

Complete Cylinder Head

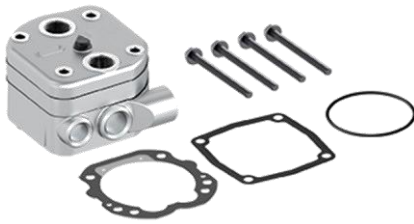

OEM Ref. 51.54114-6072 / 51.54114-6081
412 090 801 2 / 412 090 803 2 / 412 090 920 2

203.210

Cylinder Head



OEM Ref

203.250

Plate



OEM Ref.

203.270

Cooling Plate



OEM Ref.

204.300

Full Repair Kit

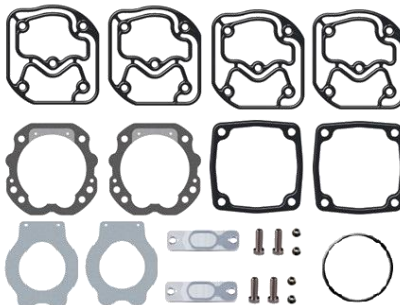

OEM Ref.

204.350

Gasket Kit

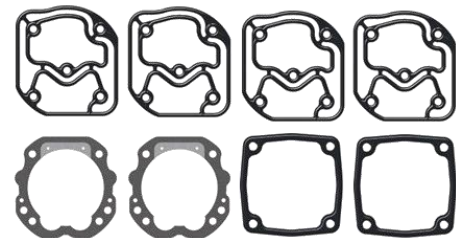

OEM Ref.

202.150 Crankcase



OEM Ref. 51.54112-6030 / 51.54112-6037

204.400 Valf Kit



OEM Ref.

110.450 Connecting Rod



OEM Ref. 51.54106-6013
403 130 22 16 / 403 130 36 16

113.700 Cylinder Liner Kit



OEM Ref. 402 130 06 08 / 402 130 02 08 / 427 130 00 08
402 131 05 02

113.720 Cylinder Liner



OEM Ref. STW63740 / 402 130 03 08

202.750 Bushing



OEM Ref. 51.93020-0335

110.500 Ø 90,00 mm Piston



OEM Ref. 403 130 05 17

110.550 Ø 90,00 mm Piston & Ring



OEM Ref.

106.600 Ø 90,00 mm Ring



OEM Ref. 51.02503-0562 / 51.02503-0772

110.510 Ø 90,25mm

110.560 Ø 90,25mm

106.610 Ø 90,25mm

110.520 Ø 90,50mm

110.570 Ø 90,50mm

106.620 Ø 90,50mm

204.800 Crankshaft



OEM Ref. 51.54113-0016 / 51.54113-0022 / 51.54113-0029
51.54113-5001 / 51.54113-5003 / 51.54113-5015

204.820 Gear



OEM Ref. 51.54210-0138

202.760 Roller Bearing



OEM Ref. 51.93420-0016

ASEL CODE

204.110

OEM Reference

51.54100-6007 / 51.54100-6008

**Kullanılan Araç
Vehicle Application**

TGA SERIES

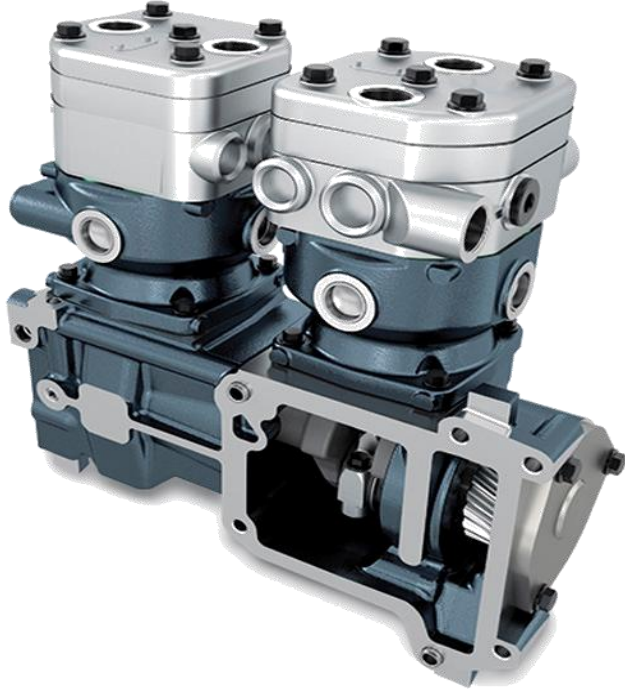

Technical Data

Cylinder Bore	Ø 90.00 mm
Swept Volume	585 cc
Stroke	46 mm

203.200

Complete Cylinder Head

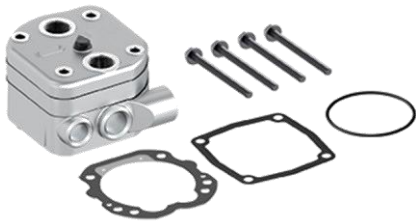

OEM Ref. 51.54114-6072 / 51.54114-6081
412 090 801 2 / 412 090 803 2 / 412 090 920 2

203.210

Cylinder Head



OEM Ref

203.250

Plate



OEM Ref.

203.270

Cooling Plate



OEM Ref.

204.300

Full Repair Kit

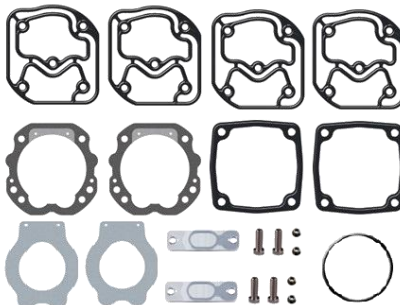

OEM Ref.

204.350

Gasket Kit

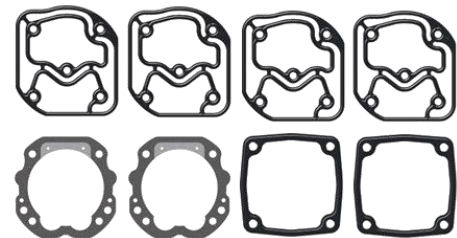

OEM Ref.

202.150 Crankcase



OEM Ref. 51.54112-6030 / 51.54112-6037

204.400 Valf Kit

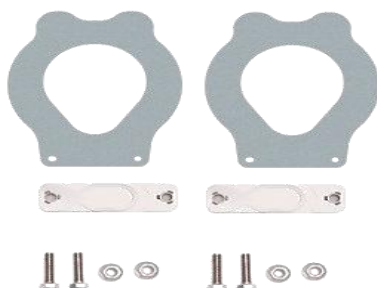

OEM Ref.

110.450 Connecting Rod



OEM Ref. 51.54106-6013
403 130 22 16 / 403 130 36 16

113.700 Cylinder Liner Kit



OEM Ref. 402 130 06 08 / 402 130 02 08 / 427 130 00 08
402 131 05 02

113.720 Cylinder Liner



OEM Ref. STW63740 / 402 130 03 08

110.775 Connecting Rod Bearing Kit



OEM Ref. 403 131 02 33

110.500 Ø 90,00 mm Piston



OEM Ref. 403 130 05 17

110.550 Ø 90,00 mm Piston & Ring



OEM Ref.

106.600 Ø 90,00 mm Ring



OEM Ref. 51.02503-0562 / 51.02503-0772

110.510 Ø 90,25mm

110.560 Ø 90,25mm

106.610 Ø 90,25mm

110.520 Ø 90,50mm

110.570 Ø 90,50mm

106.620 Ø 90,50mm

204.800 Crankshaft



OEM Ref. 51.54113-0016 / 51.54113-0022 / 51.54113-0029
51.54113-5001 / 51.54113-5003 / 51.54113-5015

204.825 Gear



OEM Ref. 51.54210-0123

202.760 Roller Bearing



OEM Ref. 51.93420-0016

ASEL CODE

204.120

OEM Reference

51.54100-6009

**Kullanılan Araç
Vehicle Application**

TGA SERIES

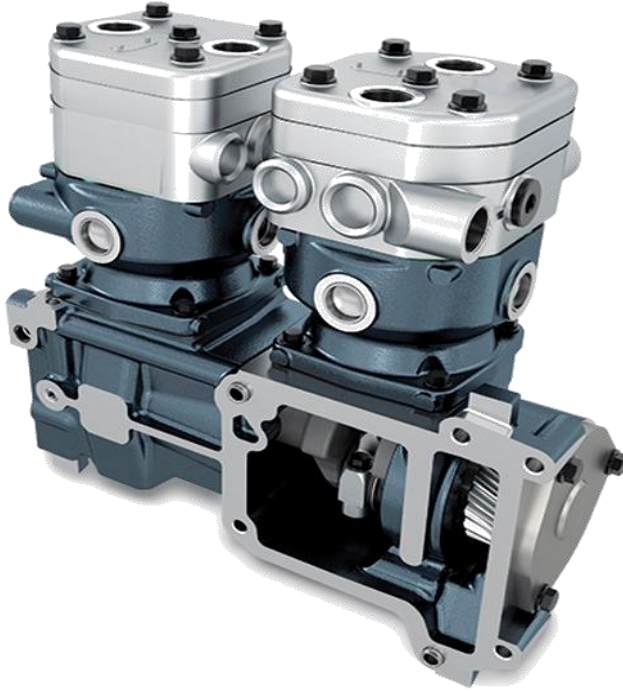

Technical Data

Cylinder Bore	Ø 90.00 mm
Swept Volume	585 cc
Stroke	46 mm

203.200

Complete Cylinder Head

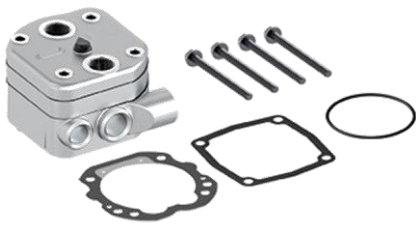

OEM Ref. 51.54114-6072 / 51.54114-6081
412.090.801.2 / 412.090.803.2 / 412.090.920.2

203.210

Cylinder Head



OEM Ref

203.250

Plate



OEM Ref.

203.270

Cooling Plate



OEM Ref.

204.300

Full Repair Kit

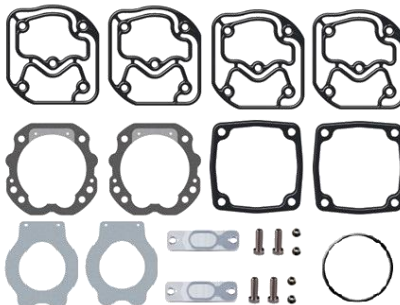

OEM Ref.

204.350

Gasket Kit

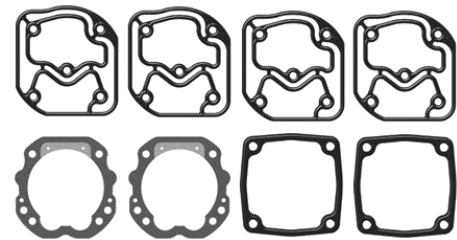

OEM Ref.

204.150 Crankcase



OEM Ref. 51.54112-6033 / 51.54112-6020

204.400 Valf Kit

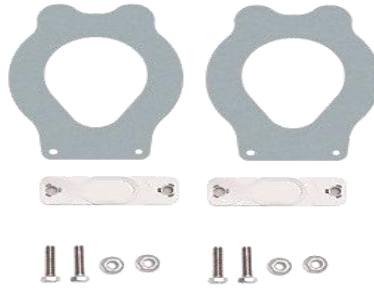

OEM Ref.

110.450 Connecting Rod



OEM Ref. 51.54106-6013
403 130 22 16 / 403 130 36 16

113.700 Cylinder Liner Kit



OEM Ref. 402 130 06 08 / 402 130 02 08 / 427 130 00 08
402 131 05 02

113.720 Cylinder Liner



OEM Ref. STW63740 / 402 130 03 08

204.855 Dirivng



OEM Ref. 51.47104-5004 / 51.47104-5005

110.500 Ø 90,00 mm Piston



OEM Ref. 403 130 05 17

110.550 Ø 90,00 mm Piston & Ring



OEM Ref.

106.600 Ø 90,00 mm Ring



OEM Ref. 51.02503-0562 / 51.02503-0772

110.510 Ø 90,25mm

110.560 Ø 90,25mm

106.610 Ø 90,25mm

110.520 Ø 90,50mm

110.570 Ø 90,50mm

106.620 Ø 90,50mm

204.810 Crankshaft



OEM Ref. 51.54113-5020

204.830 Gear



OEM Ref. 51.54210-0124

204.845 Flange



OEM Ref. 51.54130-0019

ASEL CODE

204.130

OEM Reference

51.54100-6010

**Kullanılan Araç
Vehicle Application**

TGA SERIES

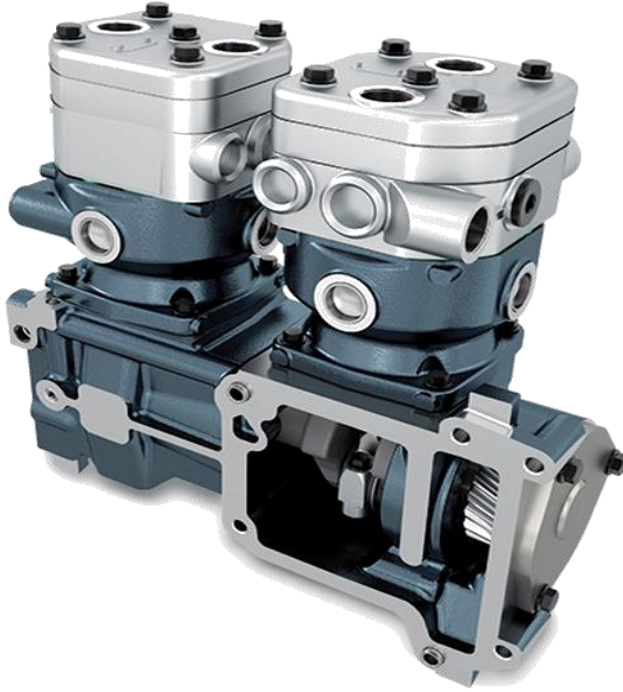

Technical Data

Cylinder Bore	Ø 90.00 mm
Swept Volume	585 cc
Stroke	46 mm

203.200

Complete Cylinder Head

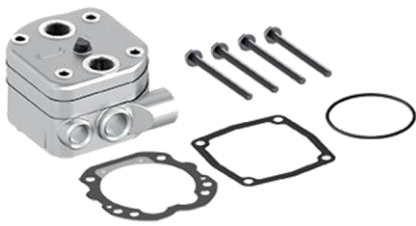

OEM Ref. 51.54114-6072 / 51.54114-6081
412.090.801.2 / 412.090.803.2 / 412.090.920.2

203.210

Cylinder Head



OEM Ref.

203.250

Plate



OEM Ref.

203.270

Cooling Plate



OEM Ref.

204.300

Full Repair Kit

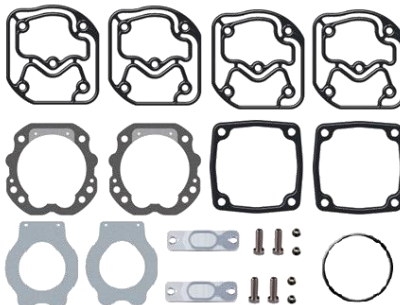

OEM Ref.

204.350

Gasket Kit

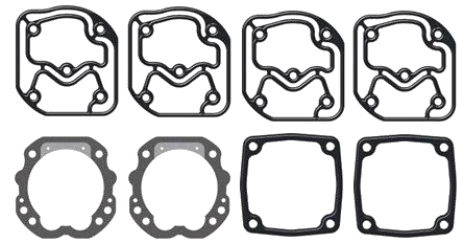

OEM Ref.

202.150

Crankcase



OEM Ref. 51.54112-6030 / 51.54112-6037

204.400

Valf Kit

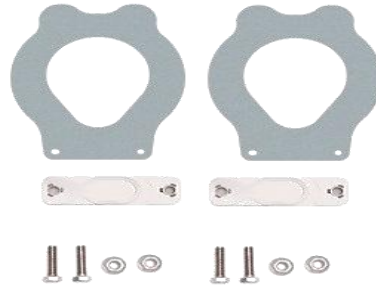

OEM Ref.

110.450

Connecting Rod



OEM Ref. 51.54106-6013
403 130 22 16 / 403 130 36 16

113.700

Cylinder Liner Kit



OEM Ref. 402 130 06 08 / 402 130 02 08 / 427 130 00 08
402 131 05 02

113.720

Cylinder Liner



OEM Ref. STW63740 / 402 130 03 08

202.165

Cover



OEM Ref.

110.500

∅ 90,00 mm

Piston

110.510

∅ 90,25mm

110.520

∅ 90,50mm



OEM Ref. 403 130 05 17

110.550

∅ 90,00 mm

Piston & Ring

110.560

∅ 90,25mm

110.570

∅ 90,50mm



OEM Ref.

106.600

∅ 90,00 mm

Ring

106.610

∅ 90,25mm

106.620

∅ 90,50mm



OEM Ref. 51.02503-0562 / 51.02503-0772

202.800

Crankshaft

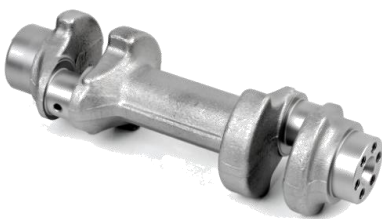

OEM Ref. 51.54113-5044

204.815

Gear



OEM Ref. 51.54210-0135

202.760

Roller Bearing



OEM Ref. 51.93420-0016

ASEL CODE	205.100
OEM Reference	51.54100-7219 / 51.54100-7254 / 51.54100-9254
Kullanılan Araç Vehicle Application	MAN



Technical Data	
Cylinder Bore	Ø 85.00 mm
Swept Volume	568 cc
Stroke	46 mm

205.200 Complete Cylinder Head

OEM Ref. 81.54114-6022
911 514 800 2

118.210 Cylinder Head

OEM Ref. 411 151 653 4 / 411 141 654 4

119.250 Plate

OEM Ref. 411 151 652 2

205.300 Full Repair Kit

OEM Ref.

205.320 Repair Kit

OEM Ref.

205.350 Gasket Kit

OEM Ref.

ASEL CODE**205.110****OEM Reference**

51.54100-7261

**Kullanılan Araç
Vehicle Application**

MAN

**Technical Data**

Cylinder Bore	Ø 85.00 mm
Swept Volume	568 cc
Stroke	46 mm

205.200**Complete Cylinder Head**OEM Ref. 81.54114-6022
911 514 800 2**118.210****Cylinder Head**

OEM Ref. 411 151 653 4 / 411 141 654 4

118.250**Plate**

OEM Ref. 411 151 652 2

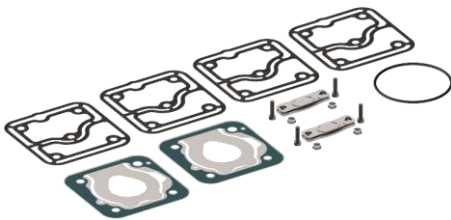
205.310**Full Repair Kit**

OEM Ref.

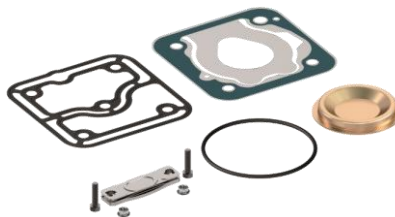
205.330**Repair Kit**

OEM Ref.

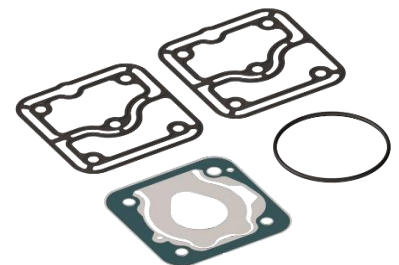
205.360**Gasket Kit**

OEM Ref.

ASEL CODE**206.100****OEM Reference**

51.54100-7240 / 9500928

**Kullanılan Araç
Vehicle Application**

LE SERIES / TGL / TGM / D0834 – D0836 ENGINE

**Technical Data**

Cylinder Bore	Ø 85.00 mm
Swept Volume	352 cc
Stroke	62 mm

206.200**Complete Cylinder Head**OEM Ref. 51.54100-6043
411 151 920 2**118.210****Cylinder Head**

OEM Ref. 411 151 653 4 / 411 141 654 4

119.250**Plate**

OEM Ref. 411 151 652 2

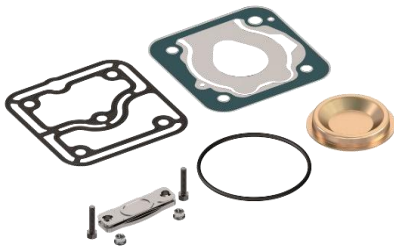
205.330**Full Repair Kit**

OEM Ref.

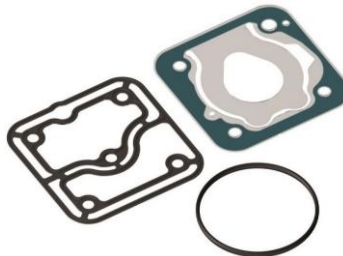
206.350**Gasket Kit**

OEM Ref.

101.450**Connecting Rod**OEM Ref. 51.54106-6023
911 145 738 2 / 912 000 730 2

ASEL CODE	206.110
OEM Reference	51.54100-7171 / 912 116 001 0
Kullanılan Araç Vehicle Application	TGL / TGM / D0834 ENGINE



Technical Data	
Cylinder Bore	Ø 85.00 mm
Swept Volume	352 cc
Stroke	62 mm

206.200 Complete Cylinder Head



OEM Ref. 51.54100-6043
411 151 920 2

118.210 Cylinder Head



OEM Ref. 411 151 653 4 / 411 141 654 4

119.250 Plate



OEM Ref. 411 151 652 2

205.330 Full Repair Kit



OEM Ref.

205.410 Valf Kit

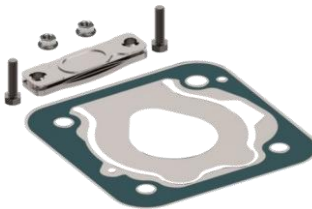

OEM Ref.

101.550 Ø 85,00 mm Piston & Ring

101.560 Ø 85,25 mm

101.570 Ø 85,50 mm



OEM Ref. 000 130 34 17 / 000 130 53 17
911 501 624 2 / 911 501 625 2

ASEL CODE

207.100

OEM Reference

51.54000-7110 / 51.54000-7059

**Kullanılan Araç
Vehicle Application**

19.260 / 19.360 / 19.361 / 1919 / 1922

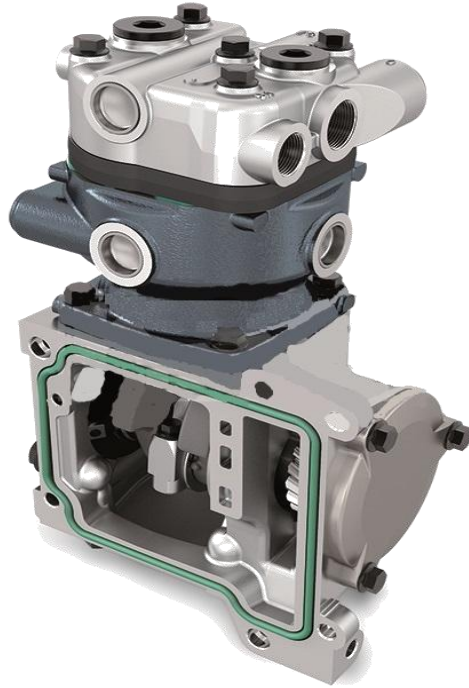

Technical Data

Cylinder Bore	Ø 90.00 mm
Swept Volume	292 cc
Stroke	46 mm

125.200

Complete Cylinder Head

125.210

Cylinder Head

125.250

Plate

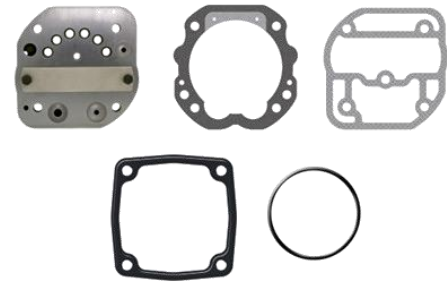
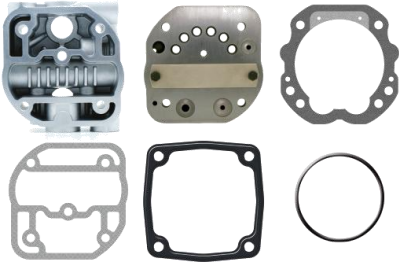

OEM Ref. 411 033 801 2 / 411 033 806 2 / 411 033 808 2

OEM Ref 411 033 653 2

OEM Ref. 411 033 503 2 / 411 033 505 2
81 54124 6013

125.300

Full Repair Kit

125.320

Repair Kit

125.350

Gasket Kit

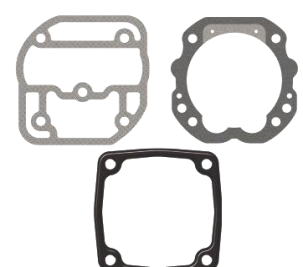
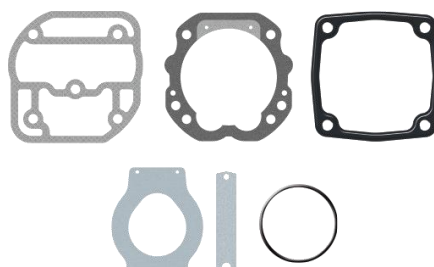
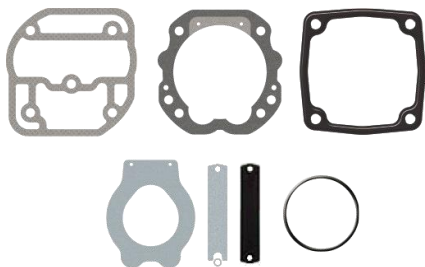

OEM Ref.

OEM Ref.

OEM Ref.

110.150 Crankcase

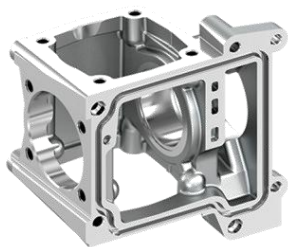

OEM Ref. 51.54112-6003 / 51.54112-6008
407 130 06 10

110.400 Valve Kit

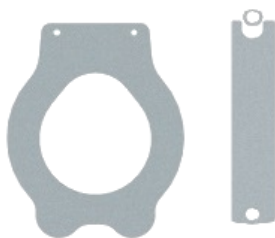

OEM Ref.

110.450 Connecting Rod



OEM Ref. 51.54106-6013
403 130 28 16 / 403 130 22 16

113.700 Cylinder Liner Kit



OEM Ref. 402 130 06 08 / 402 130 02 08 / 427 130 00 08
402 131 05 02

113.720 Cylinder Liner



OEM Ref. STW63740 / 402 130 03 08

110.160 Cover



OEM Ref.

110.500 Ø 90,00 mm Piston



OEM Ref. 403 130 05 17

110.550 Ø 90,00 mm Piston & Ring



OEM Ref.

106.600 Ø 90,00 mm Ring



OEM Ref.

110.510 Ø 90,25mm

110.560 Ø 90,25mm

106.610 Ø 90,25mm

110.520 Ø 90,50mm

110.570 Ø 90,50mm

106.620 Ø 90,50mm

110.800 Crankshaft



OEM Ref. 51.54113-5017 / 51.54113-5027
403 131 07 16

110.820 Gear



OEM Ref. 51.54210-0038
466 132 00 05

110.830 Crankshaft Flange



OEM Ref. 51.54130-6021 / 51.54130-6011 / 51.54130-0040
403 130 16 45 / 403 130 06 45 / 403 130 08 45

ASEL CODE	208.100
OEM Reference	51.54000-7074
Kullanılan Araç Vehicle Application	1919 / 1922

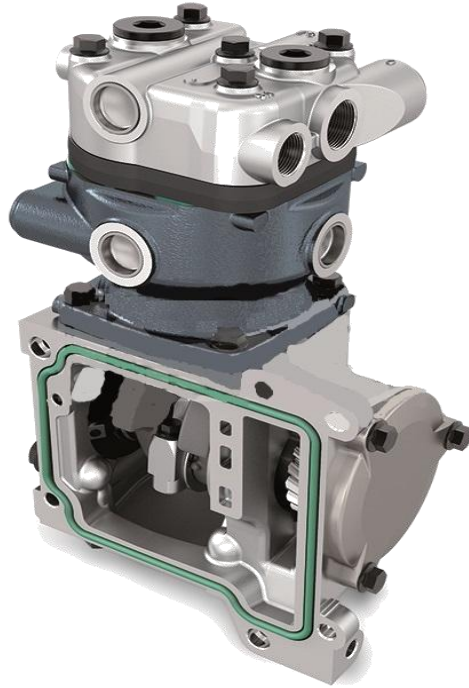

Technical Data	
Cylinder Bore	Ø 90.00 mm
Swept Volume	292 cc
Stroke	46 mm

208.200 Complete Cylinder Head

OEM Ref. 51.54114-6019
ZB4275 / I88057ES / I88057M1

208.210 Cylinder Head

OEM Ref. STW63970
ZB4275

208.250 Plate

OEM Ref. I38715F004

208.300 Full Repair Kit

OEM Ref.

208.320 Repair Kit

OEM Ref.

208.350 Gasket Kit

OEM Ref.

110.150 Crankcase

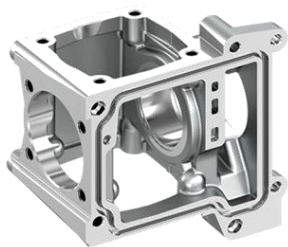

OEM Ref. 51.54112-6003 / 51.54112-6008
407 130 06 10

110.400 Valve Kit

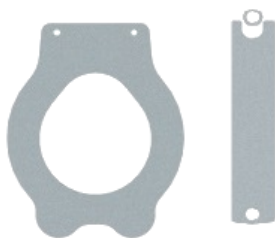

OEM Ref.

110.450 Connecting Rod



OEM Ref. 51.54106-6013
403 130 28 16 / 403 130 22 16

113.700 Cylinder Liner Kit



OEM Ref. 402 130 06 08 / 402 130 02 08 / 427 130 00 08
402 131 05 02

113.720 Cylinder Liner



OEM Ref. STW63740 / 402 130 03 08

110.160 Cover



OEM Ref.

110.500 Ø 90,00 mm Piston



OEM Ref. 403 130 05 17

110.550 Ø 90,00 mm Piston & Ring



OEM Ref.

106.600 Ø 90,00 mm Ring



OEM Ref.

110.510 Ø 90,25mm

110.560 Ø 90,25mm

106.610 Ø 90,25mm

110.520 Ø 90,50mm

110.570 Ø 90,50mm

106.620 Ø 90,50mm

110.800 Crankshaft



OEM Ref. 51.54113-5017 / 51.54113-5027
403 131 07 16

110.820 Gear



OEM Ref. 51.54210-0038
466 132 00 05

110.830 Crankshaft Flange



OEM Ref. 51.54130-6021 / 51.54130-6011 / 51.54130-0040
403 130 16 45 / 403 130 06 45 / 403 130 08 45

ASEL CODE

209.100

OEM Reference

51.54000-7130 / 51.54000-7135 / 51.54000-7079 / 447 130 04 15

**Kullanılan Araç
Vehicle Application**

F2000 – NEOPLAN / 19.422 – 19.423 / 26.281

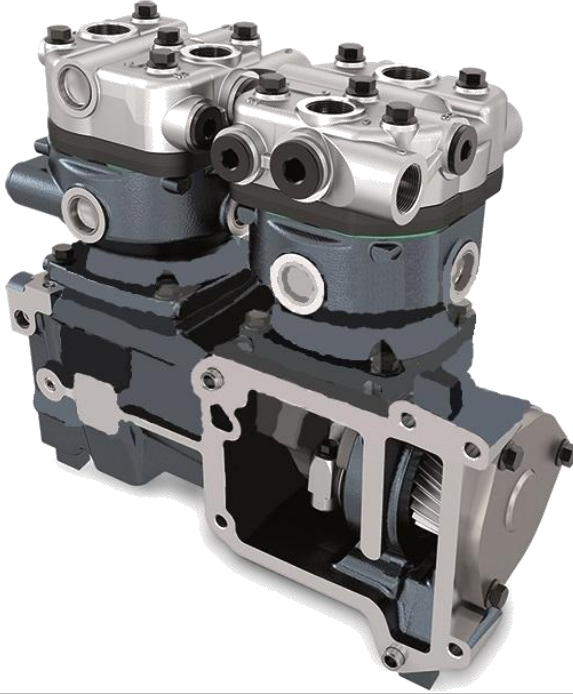

Technical Data

Cylinder Bore	Ø 90.00 mm
Swept Volume	585 cc
Stroke	46 mm

125.200

Complete Cylinder Head

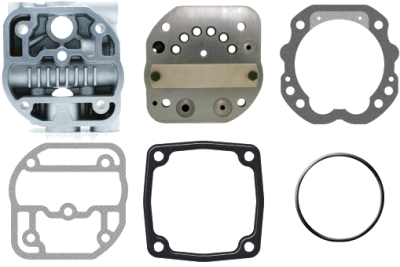

OEM Ref. 51.54114-6514 / 51.54114-6045 / 51.54111-6054
411 033 801 2 / 411 033 806 2 / 411 033 808 2

125.210

Cylinder Head



OEM Ref. 81.54111-0026
000 131 43 19 / 000 131 16 21
411 033 653 2 / 411 033 657 2

125.250

Plate



OEM Ref. 81.54124-6013 / 81.54124-6017
411 033 503 2 / 411 033 505 2
000 130 56 20 / 000 130 51 20

209.300

Full Repair Kit

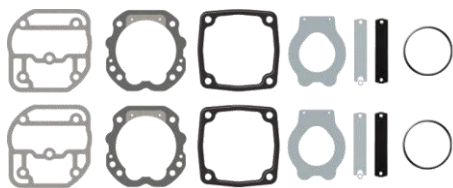

OEM Ref.

209.320

Repair Kit



OEM Ref.

209.350

Gasket Kit

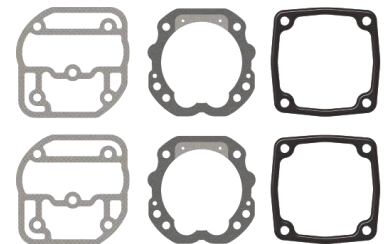

OEM Ref.

204.150

Crankcase



OEM Ref. 51.54112-6033 / 51.54112-6020

110.400

Valve Kit



OEM Ref.

110.450

Connecting Rod



OEM Ref. 51.54106-6013
403 130 36 16 / 403 130 22 16

113.700

Cylinder Liner Kit



OEM Ref. 402 130 06 08 / 402 130 02 08 / 427 130 00 08
402 131 05 02

113.720

Cylinder Liner



OEM Ref. STW63740 / 402 130 03 08

110.775

Connecting Rod Bearing Kit



OEM Ref. 51.54121-6001
403 131 02 33

110.500

Ø 90,00 mm

Piston

110.510

Ø 90,25mm

110.520

Ø 90,50mm



OEM Ref. 403 130 05 17

110.550

Ø 90,00 mm

Piston & Ring

110.560

Ø 90,25mm

110.570

Ø 90,50mm



OEM Ref.

106.600

Ø 90,00 mm

Ring

106.610

Ø 90,25mm

106.620

Ø 90,50mm



OEM Ref.

209.800

Crankshaft



OEM Ref. 51.54113-0038 / 51.54113-5014
51.54113-5025

204.820

Gear



OEM Ref. 51.54210-0138

209.760

Roller Bearing



OEM Ref. 51.93420-0015 / 51.93420-0009

ASEL CODE

209.110

OEM Reference

51.54100-6001 / 51.54100-6021

**Kullanılan Araç
Vehicle Application**

LIONS SERIES / TOURLINER / D2866 / D2876 ENGINE

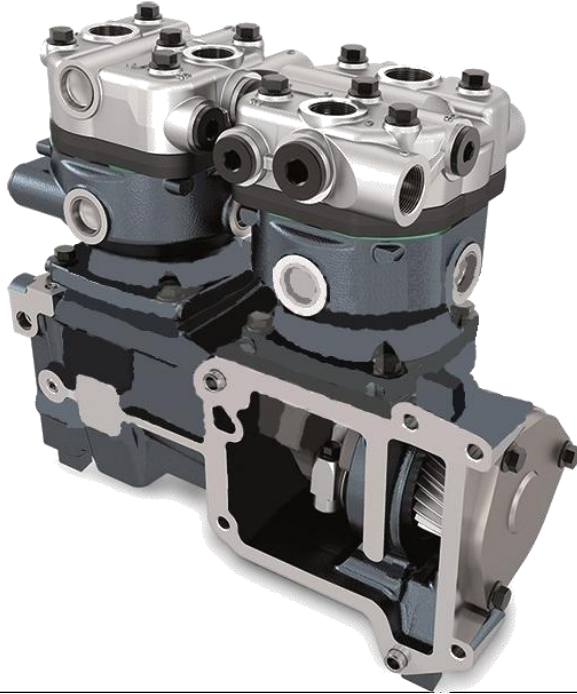

Technical Data

Cylinder Bore	Ø 90.00 mm
Swept Volume	585 cc
Stroke	46 mm

125.200

Complete Cylinder Head

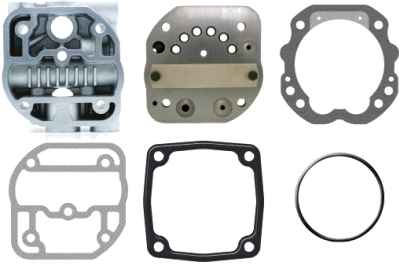

OEM Ref. 51.54114-6514 / 51.54114-6045 / 51.54111-6054
411 033 801 2 / 411 033 806 2 / 411 033 808 2

125.210

Cylinder Head



OEM Ref. 81.54111-0026
000 131 43 19 / 000 131 16 21
411 033 653 2 / 411 033 657 2

125.250

Plate

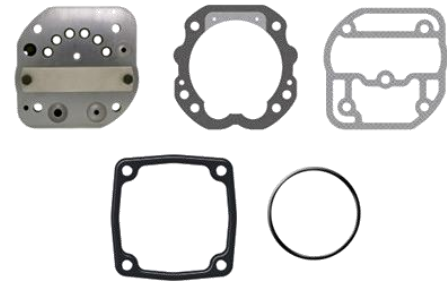

OEM Ref. 81.54124-6013 / 81.54124-6017
411 033 503 2 / 411 033 505 2
000 130 56 20 / 000 130 51 20

209.300

Full Repair Kit

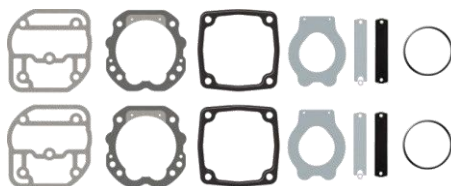

OEM Ref.

209.320

Repair Kit



OEM Ref.

209.350

Gasket Kit

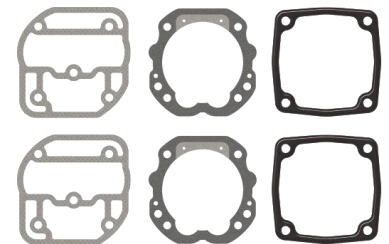

OEM Ref.

202.150

Crankcase



OEM Ref. 51.54112-6030 / 51.54112-6037

204.400

Valf Kit

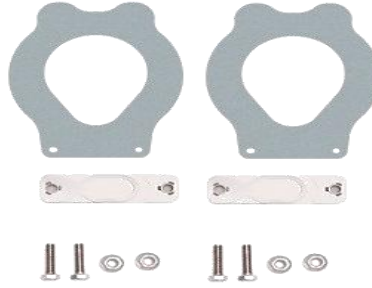

OEM Ref.

110.450

Connecting Rod



OEM Ref. 51.54106-6013
403 130 22 16 / 403 130 36 16

113.700

Cylinder Liner Kit



OEM Ref. 402 130 06 08 / 402 130 02 08 / 427 130 00 08
402 131 05 02

113.720

Cylinder Liner



OEM Ref. STW63740 / 402 130 03 08

110.775

Connecting Rod Bearing Kit



OEM Ref. 51.54121-6001
403 131 02 33

110.500

Ø 90,00 mm

Piston

110.510

Ø 90,25mm

110.520

Ø 90,50mm



OEM Ref. 403 130 05 17

110.550

Ø 90,00 mm

Piston & Ring

110.560

Ø 90,25mm

110.570

Ø 90,50mm



OEM Ref.

106.600

Ø 90,00 mm

Ring

106.610

Ø 90,25mm

106.620

Ø 90,50mm



OEM Ref.

202.800

Crankshaft

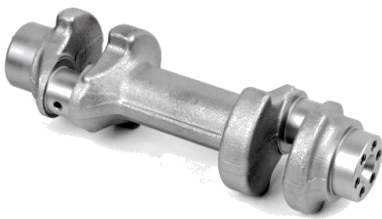

OEM Ref. 51.54113-5044

202.820

Gear



OEM Ref. 51.54210-0182

202.760

Roller Bearing



OEM Ref. 51.93420-0016

ASEL CODE

210.100

OEM Reference

51.541000-7058 / 51.54000-7112

**Kullanılan Araç
Vehicle Application**

19.260 / 19.360 / 19.361 / 1919 / 1922

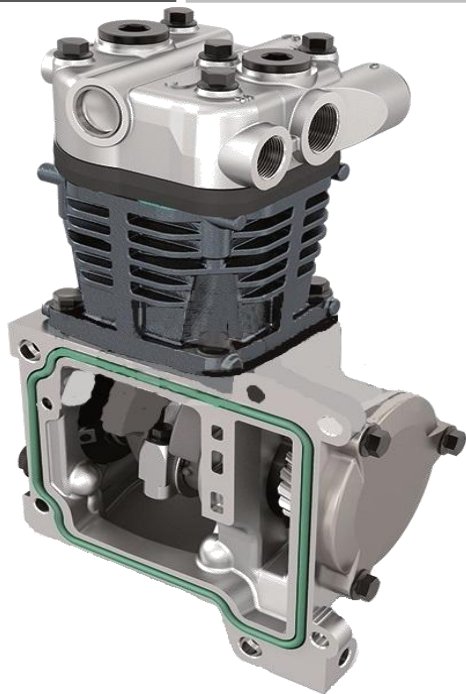

Technical Data

Cylinder Bore	Ø 90.00 mm
Swept Volume	292 cc
Stroke	46 mm

125.200

Complete Cylinder Head

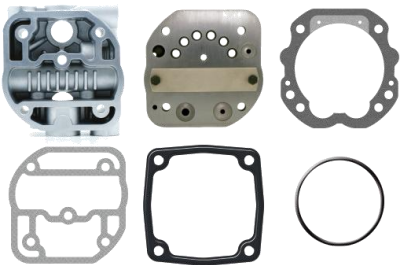

OEM Ref. 51.54114-6514 / 51.54114-6045 / 51.54111-6054
411 033 801 2 / 411 033 806 2 / 411 033 808 2

125.210

Cylinder Head



OEM Ref 81.54111 0026
411 033 653 2

125.250

Plate



OEM Ref. 411 033 503 2 / 411 033 505 2
81 54124 6013

125.300

Full Repair Kit

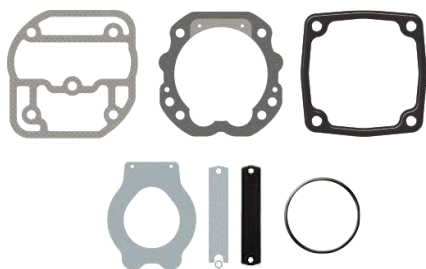

OEM Ref.

125.320

Repair Kit

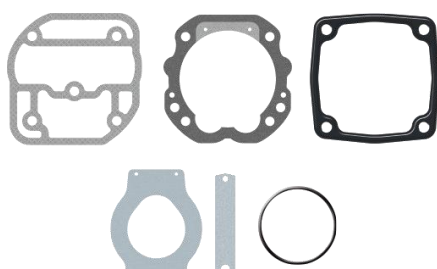

OEM Ref.

125.350

Gasket Kit

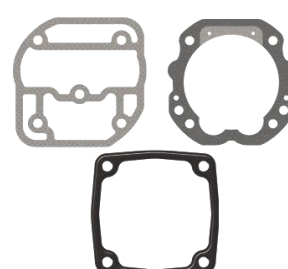

OEM Ref.

110.150

Crankcase

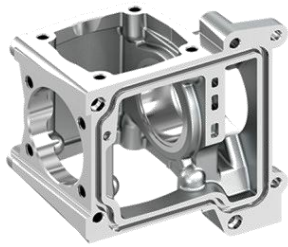

OEM Ref. 407 130 06 10

110.450

Connecting Rod



OEM Ref. 403 130 28 16 / 403 130 22 16

110.775

Connecting Rod Bearing Kit



OEM Ref. 51.54121-6001
403 131 02 33

110.700

Cylinder Liner Kit



OEM Ref. 403 130 00 08 / 403 131 00 02 / 442 130 00 02 403 130 01 17 / 442 130 00 08 / 51 54160 6005 / 51 54105 0007 / 51 54105 6008

110.720

Cylinder Liner



OEM Ref. 403 131 20 02
51 54160 6006

110.750

Bushing



OEM Ref. 51.93020-1007
403 131 04 50

110.500

∅ 90,00 mm

Piston

110.510

∅ 90,25mm

110.520

∅ 90,50mm



OEM Ref. 403 130 05 17

110.550

∅ 90,00 mm

Piston & Ring

110.560

∅ 90,25mm

110.570

∅ 90,50mm



OEM Ref.

106.600

∅ 90,00 mm

Ring

106.610

∅ 90,25mm

106.620

∅ 90,50mm



OEM Ref. 51.02503-0638 / 51.02503-0562

110.800

Crankshaft



OEM Ref. 51.54113-5017 / 51.54113-5027
403 131 07 16

110.820

Gear



OEM Ref. 51.54210-0038
466 132 00 05

110.830

Crankshaft Flange



OEM Ref. 51.54130-6021 / 51.54130-6011 / 51.54130-0040
403 130 16 45 / 403 130 06 45 / 403 130 08 45

ASEL CODE	211.100
OEM Reference	51.541000-7058
Kullanılan Araç Vehicle Application	1919 / 1922



Technical Data	
Cylinder Bore	Ø 90.00 mm
Swept Volume	292 cc
Stroke	46 mm

208.200 Complete Cylinder Head

OEM Ref. 51.54114-6019
ZB4275 / I88057ES / I88057M1

208.210 Cylinder Head

OEM Ref. STW63970
ZB4275

208.250 Plate

OEM Ref. I38715F004

208.300 Full Repair Kit

OEM Ref.

208.320 Repair Kit

OEM Ref.

208.350 Gasket Kit

OEM Ref.

110.150 Crankcase

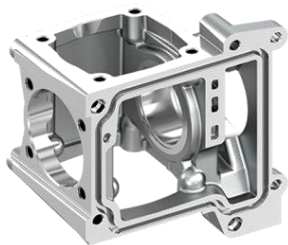

OEM Ref. 407 130 06 10

110.450 Connecting Rod



OEM Ref. 51.54106-6013
403 130 28 16 / 403 130 22 16

110.775 Connecting Rod Bearing Kit



OEM Ref. 51.54121-6001
403 131 02 33

110.700 Cylinder Liner Kit



OEM Ref. 403 130 00 08 / 403 131 00 02 / 442 130 00 02 403 130 01 17 / 442 130 00 08 / 51 54160 6005 / 51 54105 0007 / 51 54105 6008

110.720 Cylinder Liner



OEM Ref. 403 131 20 02
51 54160 6006

110.750 Bushing



OEM Ref. 51.93020-1007
403 131 04 50

110.500 Ø 90,00 mm Piston



OEM Ref. 403 130 05 17

110.550 Ø 90,00 mm Piston & Ring



OEM Ref.

106.600 Ø 90,00 mm Ring



OEM Ref. 51.02503-0638 / 51.02503-0562

110.510 Ø 90,25mm

110.560 Ø 90,25mm

106.610 Ø 90,25mm

110.520 Ø 90,50mm

110.570 Ø 90,50mm

106.620 Ø 90,50mm

110.800 Crankshaft



OEM Ref. 51.54113-5017 / 51.54113-5027
403 131 07 16

110.820 Gear



OEM Ref. 51.54210-0038
466 132 00 05

110.830 Crankshaft Flange



OEM Ref. 51.54130-6021 / 51.54130-6011 / 51.54130-0040
403 130 16 45 / 403 130 06 45 / 403 130 08 45

ASEL CODE

212.100

OEM Reference

51.54101-7201 / 51.54101-7205
LK3927 / I94064**

**Kullanılan Araç
Vehicle Application**

26.320 / 26.270



Technical Data

Cylinder Bore	Ø 88.00 mm
Swept Volume	300 cc
Stroke	50 mm

212.200

Complete Cylinder Head

208.210

Cylinder Head

212.250

Plate

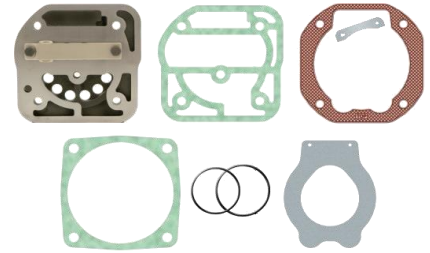

OEM Ref. ZB5275
I90153004 / I93078004

OEM Ref. STW63970

OEM Ref. I880570061

212.300

Full Repair Kit

212.320

Repair Kit

212.350

Gasket Kit

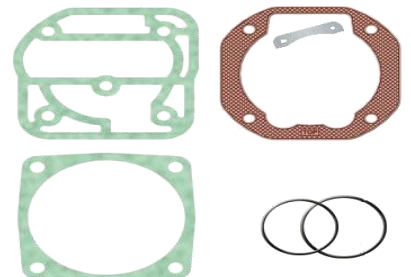
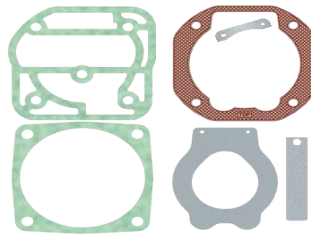
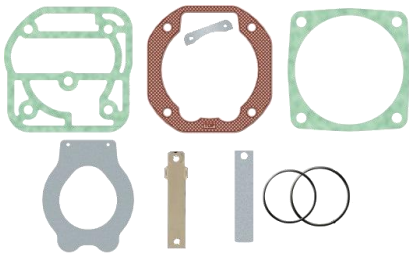

OEM Ref.

OEM Ref.

OEM Ref.

212.150

Crankcase



OEM Ref.

212.450

Connecting Rod



OEM Ref. 81.54106-0013

212.400

Valf Kit



OEM Ref.

212.700

Cylinder Liner Kit



OEM Ref. 81.54105-6009
I789790061

212.720

Cylinder Liner



OEM Ref. 81.54105-0024

212.750

Bushing



OEM Ref.

107.500

Ø 88,00 mm

Piston

107.510

Ø 88,25 mm

10.520

Ø 88,50 mm



OEM Ref.

107.550

Ø 88,00 mm

Piston & Ring

107.560

Ø 88,25 mm

107.570

Ø 88,50 mm



OEM Ref. 000 130 11 17
411 042 620 2

107.600

Ø 88,00 mm

Ring

107.610

Ø 88,25 mm

107.620

Ø 88,50 mm



OEM Ref. 81.54103-6000
001 131 06 11 / I139526F0061 / I811690062

212.800

Crankshaft



OEM Ref.

212.820

Gear



OEM Ref. 51.54210-0070 / 51.54210-0108
51.54210-0089 / 51.54210-0084

212.830

Crankshaft Flange



OEM Ref.

ASEL CODE

212.110

OEM Reference

51.54101-7204 / 51.54101-7171 51.54101-7186 / 51.54101-7197
LK3812 / LK3868 / I134069 / I94063

**Kullanılan Araç
Vehicle Application**

M2000 / L2000 / BUS / G90 / M90



Technical Data

Cylinder Bore	Ø 88.00 mm
Swept Volume	225 cc
Stroke	37 mm

212.200

Complete Cylinder Head



OEM Ref. ZB5275
I90153004 / I93078004

208.210

Cylinder Head



OEM Ref. STW63970

212.250

Plate

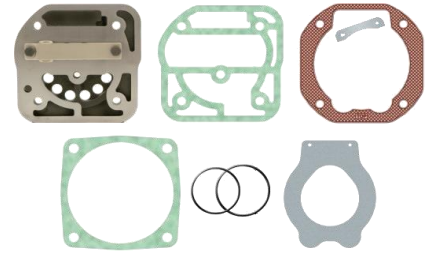

OEM Ref. I880570061

212.300

Full Repair Kit

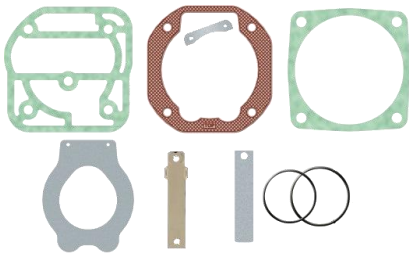

OEM Ref.

212.320

Repair Kit

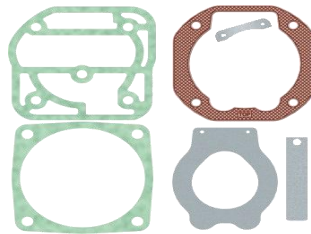

OEM Ref.

212.350

Gasket Kit

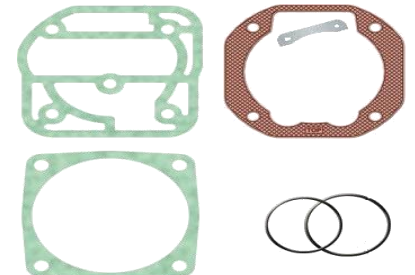

OEM Ref.

212.150

Crankcase



OEM Ref.

107.450

Connecting Rod



OEM Ref. 000 131 18 17 / 000 130 19 16
000 130 25 17 / I80110 / I60599

212.400

Valf Kit



OEM Ref.

212.700

Cylinder Liner Kit



OEM Ref. 81.54105-6009
I789790061

212.720

Cylinder Liner



OEM Ref. 81.54105-0024

212.750

Bushing



OEM Ref.

107.500

Ø 88,00 mm

Piston

107.510

Ø 88,25 mm

10.520

Ø 88,50 mm



OEM Ref.

107.550

Ø 88,00 mm

Piston & Ring

107.560

Ø 88,25 mm

107.570

Ø 88,50 mm



OEM Ref. 000 130 11 17
411 042 620 2

107.600

Ø 88,00 mm

Ring

107.610

Ø 88,25 mm

107.620

Ø 88,50 mm



OEM Ref. 81.54103-6000
001 131 06 11 / I139526F0061 / I811690062

212.810

Crankshaft



OEM Ref.

212.820

Gear



OEM Ref. 51.54210-0070 / 51.54210-0108
51.54210-0089 / 51.54210-0084

212.830

Crankshaft Flange



OEM Ref.

ASEL CODE

212.120

OEM Reference

51.54101-7247 / 51.54101-9247 / LK3980 / I136925

**Kullanılan Araç
Vehicle Application**

26.230 / M2000 / L2000/ BUS/ G90 / M90



Technical Data

Cylinder Bore	Ø 88.00 mm
Swept Volume	300 cc
Stroke	50 mm

212.200

Complete Cylinder Head



OEM Ref. ZB5275
I90153004 / I93078004

208.210

Cylinder Head



OEM Ref. STW63970

212.250

Plate

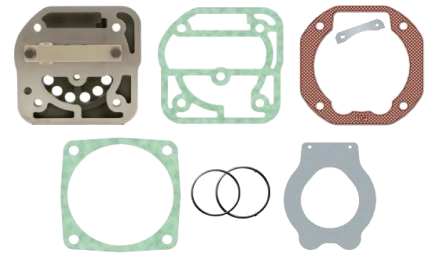

OEM Ref. I880570061

212.300

Full Repair Kit

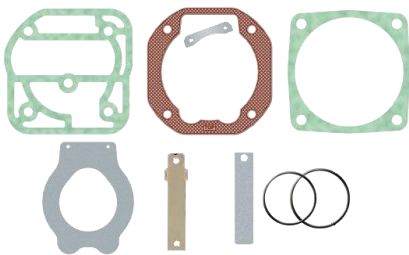

OEM Ref.

212.320

Repair Kit

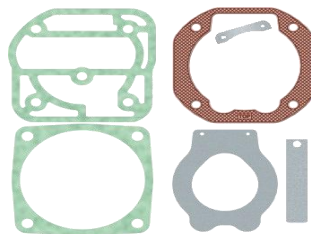

OEM Ref.

212.350

Gasket Kit

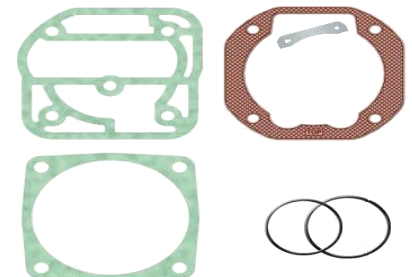

OEM Ref.

212.150

Crankcase



OEM Ref.

107.450

Connecting Rod



OEM Ref. 000 131 18 17 / 000 130 19 16
000 130 25 17 / I80110 / I60599

212.400

Valf Kit



OEM Ref.

212.700

Cylinder Liner Kit



OEM Ref. 81.54105-6009
I789790061

212.720

Cylinder Liner



OEM Ref. 81.54105-0024

212.750

Bushing



OEM Ref.

107.500

Ø 88,00 mm

Piston

107.510

Ø 88,25 mm

10.520

Ø 88,50 mm



OEM Ref.

107.550

Ø 88,00 mm

Piston & Ring

107.560

Ø 88,25 mm

107.570

Ø 88,50 mm



OEM Ref. 000 130 11 17
411 042 620 2

107.600

Ø 88,00 mm

Ring

107.610

Ø 88,25 mm

107.620

Ø 88,50 mm



OEM Ref. 81.54103-6000
001 131 06 11 / I139526F0061 / I811690062

212.800

Crankshaft



OEM Ref.

212.820

Gear



OEM Ref. 51.54210-0070 / 51.54210-0108
51.54210-0089 / 51.54210-0084

212.830

Crankshaft Flange



OEM Ref.

ASEL CODE	213.100
OEM Reference	51.54100-7070 / 51.54100-7071 / 912 116 000 0
Kullanılan Araç Vehicle Application	TGL / TGM



Technical Data	
Cylinder Bore	Ø 85.00 mm
Swept Volume	352 cc
Stroke	62 mm

213.200 Complete Cylinder Head

OEM Ref. 51.54114-6082
412 352 924 2

213.210 Cylinder Head

OEM Ref.

213.250 Plate

OEM Ref.

213.300 Full Repair Kit

OEM Ref.

213.320 Repair Kit

OEM Ref.

213.350 Gasket Kit

OEM Ref.

213.150 Crankcase



OEM Ref.

205.410 Valve Kit

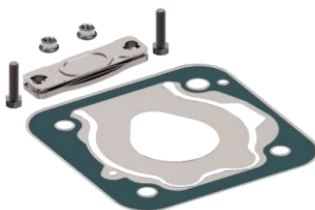

OEM Ref.

101.450 Connecting Rod



OEM Ref. 000 131 25 17 / 000 131 29 17
911 145 738 2 / 912 000 730 2 / 51.54106-6023

213.750 Bushing



OEM Ref. 81.93020-0861
000 131 33 50 / 0697288 / 411 141 205 4

213.800 Crankshaft



OEM Ref.

213.820 Gear



OEM Ref. 51.54210-0205

101.500 Ø 85,00 mm Piston

101.510 Ø 85,25 mm

101.520 Ø 85,50 mm



OEM Ref.

101.550 Ø 85,00 mm Piston & Ring

101.560 Ø 85,25 mm

101.570 Ø 85,50 mm



OEM Ref. 0697442 / 1698686 / 128371
000 130 34 17 / 911 501 624 2 / 911 501 625 2

101.600 Ø 85,00 mm Ring

101.610 Ø 85,25 mm

101.620 Ø 85,50 mm



OEM Ref. 3094621
911 501 920 2

213.830 Crankshaft Flange



OEM Ref.

213.160 Cover



ASEL CODE

213.110

OEM Reference

51.54100-7005 / 412 352 003 0

**Kullanılan Araç
Vehicle Application**

32.370/ 32.370 HX/ D0834LFL/ D0834LOH D0836LFL / D0836LOH / D0836LFG



Technical Data

Cylinder Bore	Ø 85.00 mm
Swept Volume	352 cc
Stroke	62 mm

213.200

Complete Cylinder Head



OEM Ref. 51.54114-6082
412 352 924 2

213.210

Cylinder Head

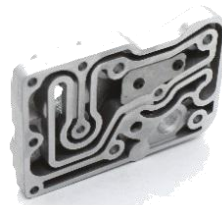

OEM Ref

213.250

Plate

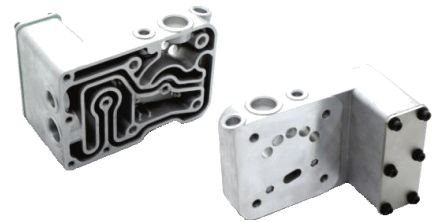

OEM Ref.

213.300

Full Repair Kit

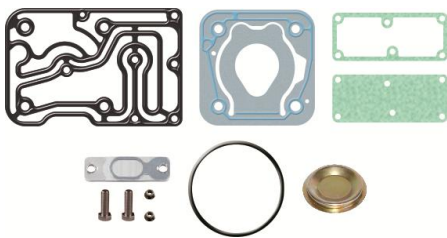

OEM Ref.

213.320

Repair Kit

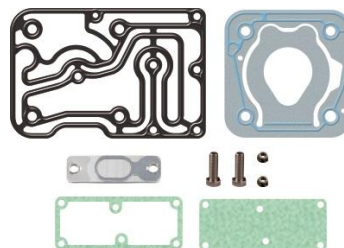

OEM Ref.

213.350

Gasket Kit

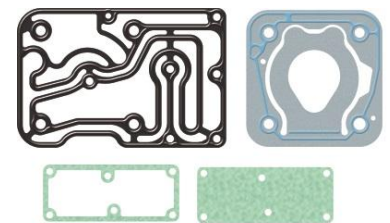

OEM Ref.

213.150 Crankcase



OEM Ref.

205.410 Valve Kit

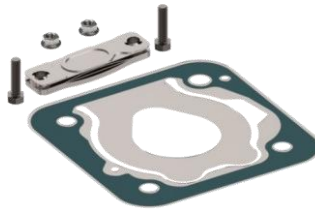

OEM Ref.

101.450 Connecting Rod



OEM Ref. 000 131 25 17 / 000 131 29 17
911 145 738 2 / 912 000 730 2 / 51.54106-6023

213.750 Bushing



OEM Ref. 81.93020-0861
000 131 33 50 / 0697288 / 411 141 205 4

213.810 Crankshaft



OEM Ref. 51.54113-0050

213.825 Gear



OEM Ref. 51.54210-0167 / 51.54210-0118

101.500 Ø 85,00 mm Piston

101.510 Ø 85,25 mm

101.520 Ø 85,50 mm



OEM Ref.

101.550 Ø 85,00 mm Piston & Ring

101.560 Ø 85,25 mm

101.570 Ø 85,50 mm



OEM Ref. 0697442 / 1698686 / 128371
000 130 34 17 / 911 501 624 2 / 911 501 625 2

101.600 Ø 85,00 mm Ring

101.610 Ø 85,25 mm

101.620 Ø 85,50 mm



OEM Ref. 3094621
911 501 920 2

213.840 Crankshaft Flange



OEM Ref.

213.160 Cover



ASEL CODE

214.100

OEM Reference

51 54100 7232 / 51 54100 7247 / LK8901 / K082139N00 / K118694N04 / K118694N00

**Kullanılan Araç
Vehicle Application**

TGA / 41 430-460-400 / TGX / TGS / FORTUNA BUS / D2066 ENGINE / NEOPLAN BUS
STARLINER / CITYLINER TOURLINER / SKYLINER / LIONS COACH LIONS REGIO / LIONS CITY



Technical Data

Cylinder Bore	Ø 92.00 mm
Swept Volume	360 cc
Stroke	54 mm

214.200

Complete Cylinder Head



OEM Ref. K114439K50

214.210

Cylinder Head



OEM Ref

214.250

Plate



OEM Ref.

214.270

Cooling Plate



OEM Ref.

214.300

Full Repair Kit

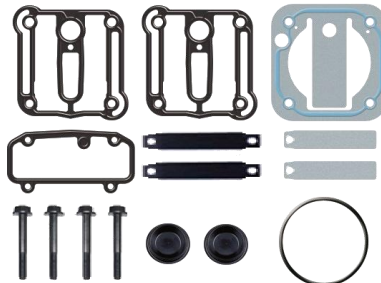

OEM Ref.

214.320

Repair Kit

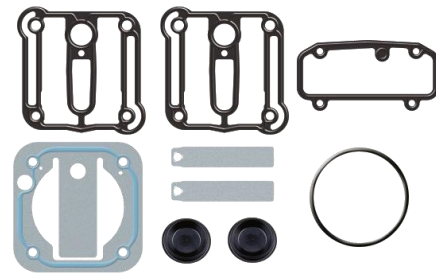

OEM Ref.

214.150 **Crankcase**



OEM Ref.

214.350 **Gasket Kit**



OEM Ref.

214.450 **Connecting Rod**



OEM Ref. SEB22464 / EB02800

214.750 **Bushing**



OEM Ref.

214.800 **Crankshaft**



OEM Ref.

214.810 **Drive Shaft**



OEM Ref.

214.500 **Ø 92,00 mm** **Piston**

214.510 **Ø 92,25 mm**

214.520 **Ø 92,50 mm**



OEM Ref.

214.550 **Ø 92,00 mm** **Piston & Ring**

214.560 **Ø 92,25 mm**

214.570 **Ø 92,50 mm**



OEM Ref. 51.54119-6008 / 51.54119-6009
K006026 / K012079 / K012079K56 / SEB22530

214.600 **Ø 92,00 mm** **Ring**

214.610 **Ø 92,25 mm**

214.620 **Ø 92,50 mm**



OEM Ref.

214.825 **Gear**



OEM Ref.

214.820 **Gear**



214.400 **Valf Kit**



ASEL CODE

214.110

OEM Reference

51.54100-7117 / 51.54100-7205 / LK8901 / K015410 / K070986 / K070986X00

**Kullanılan Araç
Vehicle Application**

TGA/41 430-460-400 / TGX / TGS / FORTUNA BUS / D2066 ENGINE / NEOPLAN BUS
STARLINER / CITYLINER TOURLINER / SKYLINER / LIONS COACH LIONS REGIO / LIONS CITY

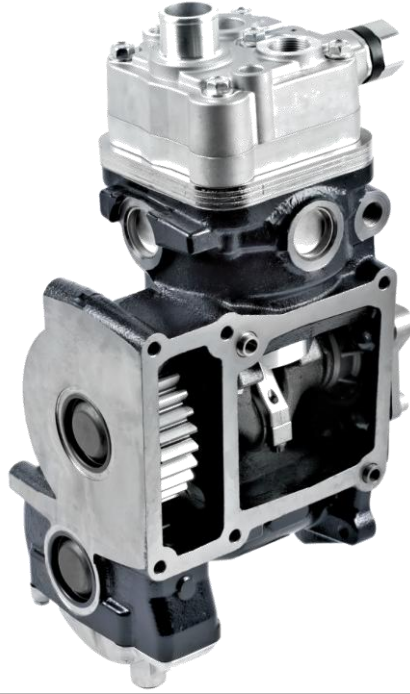

Technical Data

Cylinder Bore	Ø 92.00 mm
Swept Volume	360 cc
Stroke	54 mm

214.205

Complete Cylinder Head

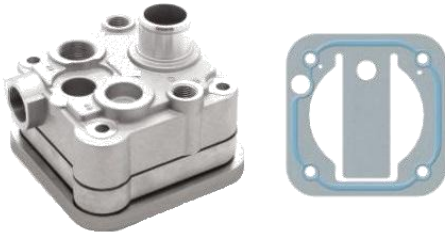

OEM Ref. 51.54114-6084
K019286

214.215

Cylinder Head



OEM Ref

214.260

Plate

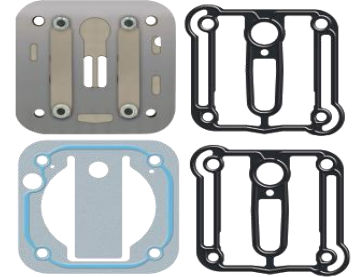

OEM Ref. 51.54124-6004
K015040

214.275

Cooling Plate



OEM Ref.

214.310

Full Repair Kit



OEM Ref.

214.330

Repair Kit

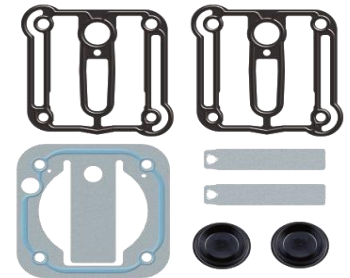

OEM Ref.

214.360 Gasket Kit

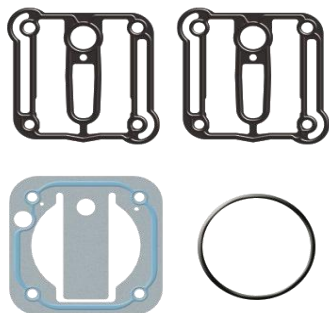

OEM Ref.

214.400 Valve Kit

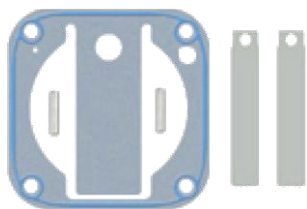

OEM Ref.

214.450 Connecting Rod



OEM Ref. SEB22464 / EB02800

214.160 Cover



OEM Ref.

214.800 Crankshaft



OEM Ref.

214.810 Drive Shaft



OEM Ref.

214.500 Ø 92,00 mm Piston

214.510 Ø 92,25 mm

214.520 Ø 92,50 mm



OEM Ref.

214.550 Ø 92,00 mm Piston & Ring

214.560 Ø 92,25 mm

214.570 Ø 92,50 mm



OEM Ref. 51.54119-6008 / 51.54119-6009
K006026 / K012079 / K012079K56 / SEB22530

214.600 Ø 92,00 mm Ring

214.610 Ø 92,25 mm

214.620 Ø 92,50 mm



OEM Ref.

214.150 Crankcase



OEM Ref.

214.820 Gear



OEM Ref.

214.830 Crankshaft Flange



OEM Ref.

ASEL CODE

215.100

OEM Reference

51.54100-7078 / 51.54100-7087 / 51.54100-7095 / LP3980 / K004489

**Kullanılan Araç
Vehicle Application**

TGA / TGX / TGS / NEOPLAN BUS / STARLINER / CITYLINER / LIONS

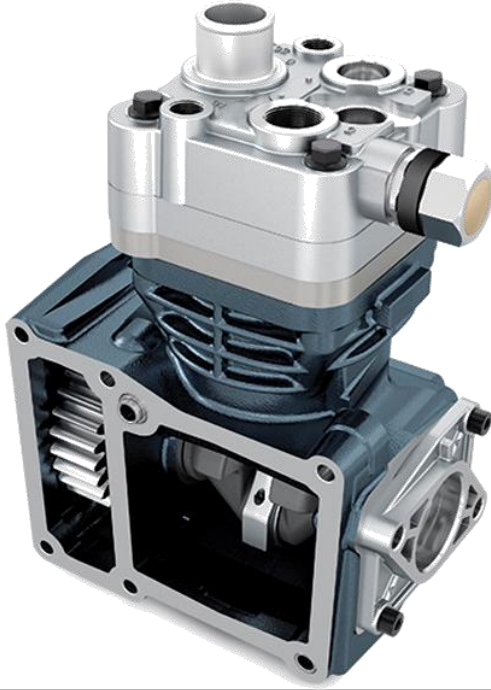

Technical Data

Cylinder Bore	Ø 92.00 mm
Swept Volume	360 cc
Stroke	54 mm

215.200

Complete Cylinder Head

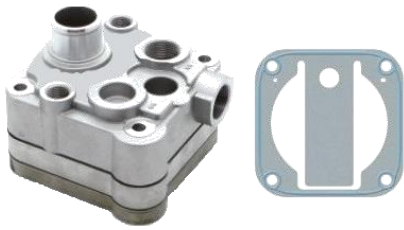

OEM Ref.

214.215

Cylinder Head



OEM Ref.

215.250

Plate

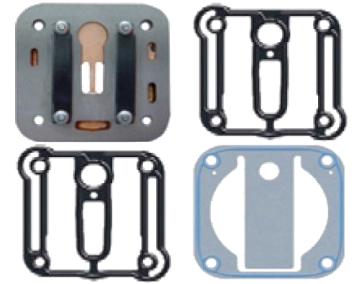

OEM Ref.

214.275

Cooling Plate



OEM Ref.

215.300

Full Repair Kit

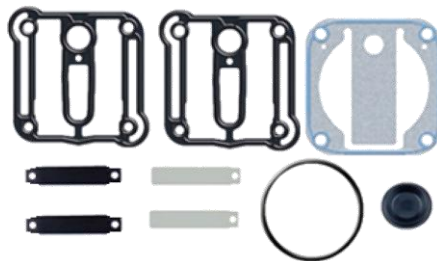

OEM Ref.

215.320

Repair Kit



OEM Ref.

215.350

Gasket Kit



OEM Ref.

215.400

Valve Kit

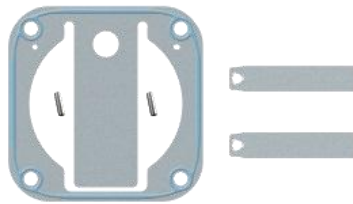

OEM Ref.

215.150

Crankcase



OEM Ref.

214.450

Connecting Rod



OEM Ref. SEB22464 / EB02800

214.800

Crankshaft



OEM Ref.

214.750

Bushing



OEM Ref.

214.500

Ø 92,00 mm

Piston

214.510

Ø 92,25 mm

214.520

Ø 92,50 mm



OEM Ref.

214.550

Ø 92,00 mm

Piston & Ring

214.560

Ø 92,25 mm

214.570

Ø 92,50 mm



OEM Ref. 51.54119-6008 / 51.54119-6009
K006026 / K012079 / K012079K56 / SEB22530

214.600

Ø 92,00 mm

Ring

214.610

Ø 92,25 mm

214.620

Ø 92,50 mm



OEM Ref.

214.820

Gear



OEM Ref.

214.830

Crankshaft Flange

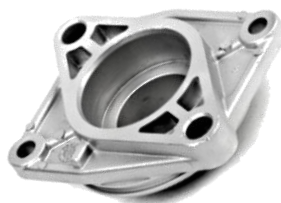

OEM Ref.

214.410

Pressure Control Valve



OEM Ref. 51.54122-8001
DR5125 / K081929K50

ASEL CODE**216.100****OEM Reference**

51.54100-7231 / 51.54100-7246 / 51.54100/9231 / LP3997 / K082069N00

**Kullanılan Araç
Vehicle Application**

TGA / TGX / TGS / NEOPLAN BUS / STARLINER / CITYLINER / LIONS

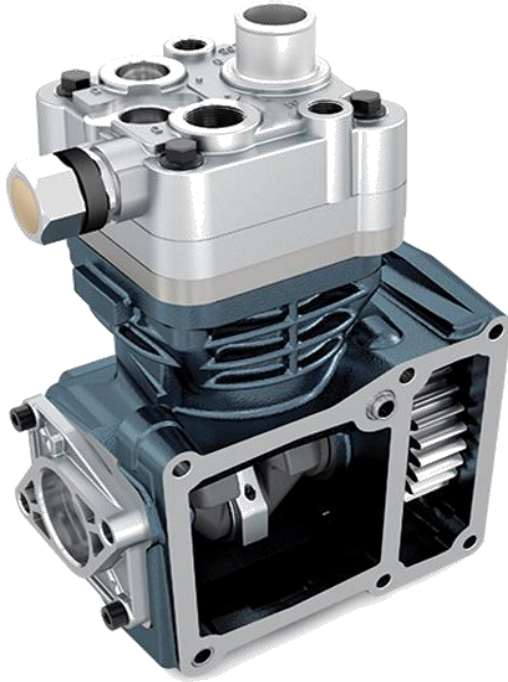
**Technical Data**

Cylinder Bore	Ø 92.00 mm
Swept Volume	360 cc
Stroke	54 mm

214.200**Complete Cylinder Head**

OEM Ref. K114439K50

214.210**Cylinder Head**

OEM Ref

214.250**Plate**

OEM Ref.

214.270**Cooling Plate**

OEM Ref.

214.310**Full Repair Kit**

OEM Ref.

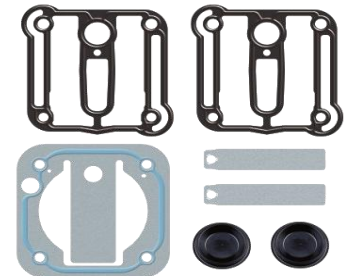
214.330**Repair Kit**

OEM Ref.

214.360

Gasket Kit

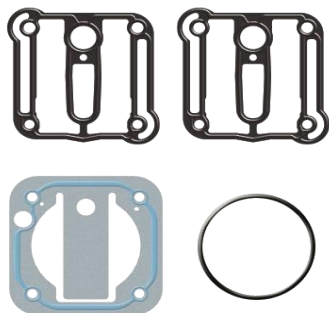

OEM Ref.

214.400

Valve Kit

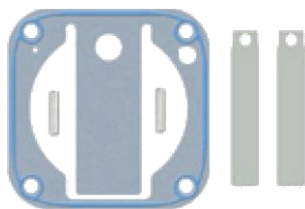

OEM Ref.

216.150

Crankcase



OEM Ref.

214.450

Connecting Rod



OEM Ref. SEB22464 / EB02800

214.800

Crankshaft



OEM Ref.

214.750

Bushing



OEM Ref.

214.500

Ø 92,00 mm

Piston

214.510

Ø 92,25 mm

214.520

Ø 92,50 mm



OEM Ref.

214.550

Ø 92,00 mm

Piston & Ring

214.560

Ø 92,25 mm

214.570

Ø 92,50 mm



OEM Ref. 51.54119-6008 / 51.54119-6009
K006026 / K012079 / K012079K56 / SEB22530

214.600

Ø 92,00 mm

Ring

214.610

Ø 92,25 mm

214.620

Ø 92,50 mm



OEM Ref.

214.820

Gear



OEM Ref.

214.830

Crankshaft Flange

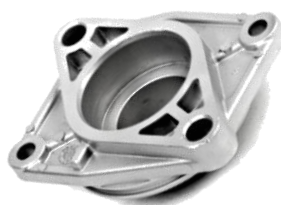

OEM Ref.

214.410

Pressure Control Valve



OEM Ref. 51.54122-8001
DR5125 / K081929K50

ASEL CODE

217.100 – 217.110

OEM Reference

**Kullanılan Araç
Vehicle Application**

16.260 / 19.360 / 19.361



217.100



217.110

Technical Data

Cylinder Bore	Ø 90.00 mm
Swept Volume	547 cc
Stroke	43 mm

110.200

Complete Cylinder Head

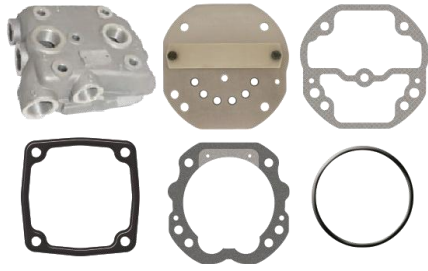

OEM Ref. ZB4187 / ZB4224 ZB4229
000 130 24 19 / 000 130 25 19 / 000 130 26 19

110.210

Cylinder Head



OEM Ref 407 131 05 19

110.250

Plate

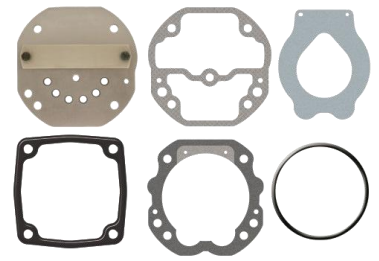

OEM Ref. 402 130 01 20 / 402 130 03 20

110.300

Full Repair Kit

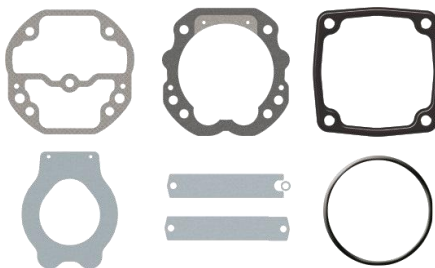

OEM Ref.

110.320

Repair Kit

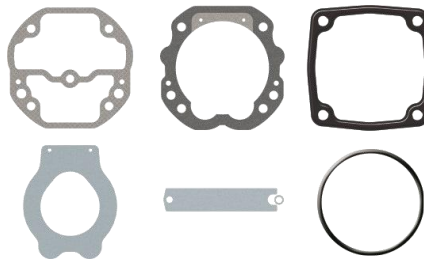

OEM Ref. 402 130 00 20 / 402 130 02 20 / 402 586 50 13

110.350

Gasket Kit

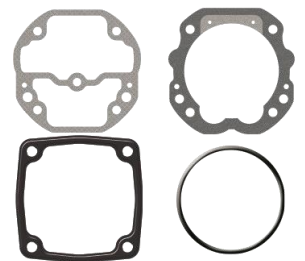

OEM Ref.

110.400

Valve Kit

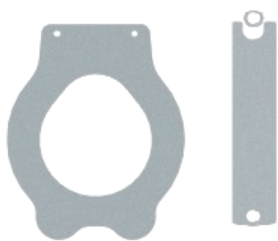

OEM Ref.

110.450

Connecting Rod



OEM Ref. 51.54106-6031 / 51.54106-6015
403 130 27 16

110.750

Bushing



OEM Ref. 51.93020-1007

217.700

Cylinder Liner Kit



OEM Ref.

110.720

Cylinder Liner



OEM Ref. 403 131 20 02
51 54160 6006

110.830

Crankshaft Flange

OEM Ref.
403 130 16 45
403 130 06 45
403 130 08 45



110.835

Crankshaft Flange

OEM Ref.



217.500

Ø 90,00 mm

Piston

217.510

Ø 90,25mm

217.520

Ø 90,50mm



OEM Ref.

217.550

Ø 90,00 mm

Piston & Ring

217.560

Ø 90,25mm

217.570

Ø 90,50mm



OEM Ref.

106.600

Ø 90,00 mm

Ring

106.610

Ø 90,25mm

106.620

Ø 90,50mm



OEM Ref.

217.705

Cylinder Liner Kit



OEM Ref.

113.720

Cylinder Liner



OEM Ref. STW63740
402 130 03 08

217.800

Crankshaft

OEM Ref.
51.54113-0021
51.54113-5032
403 130 03 14
403 131 08 16



217.820

Gear

OEM Ref. 403 130 00 30 / 442 130 05 03



ASEL CODE

218.100

OEM Reference

004 131 94 01 / 004 131 77 01 / 004 131 74 01 / LK1813 / II14570

**Kullanılan Araç
Vehicle Application**

3205 / 32053 / 32054 / 4234 / 4230 / 4230-01 / MM3D245.9
ЯМ3-236 , 238 , 7601 , 7051

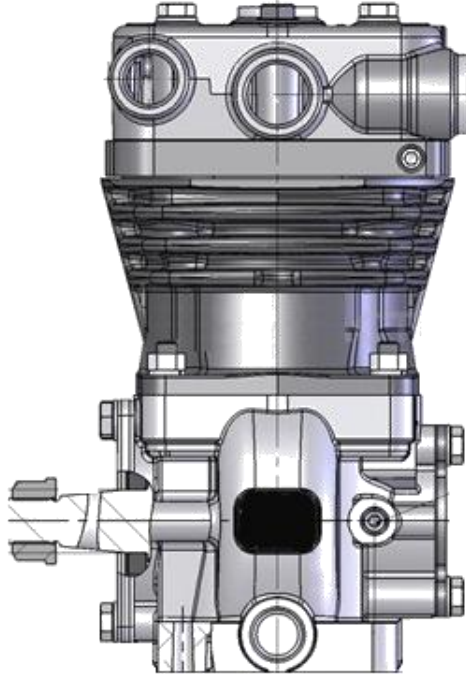

Technical Data

Cylinder Bore	Ø 88.00 mm
Swept Volume	225 cc
Stroke	37 mm

218.200

Complete Cylinder Head



OEM Ref.

218.210

Cylinder Head



OEM Ref.

218.250

Plate

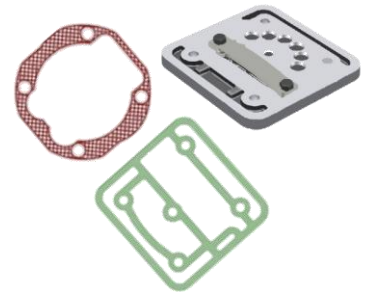

OEM Ref.

218.300

Full Repair Kit

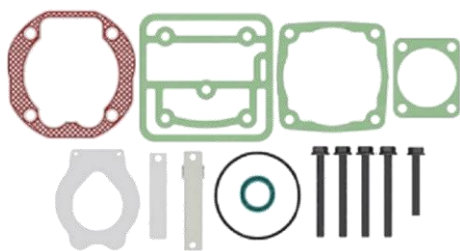

OEM Ref.

218.320

Repair Kit

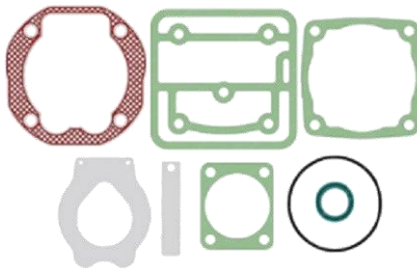

OEM Ref.

218.350

Gasket Kit

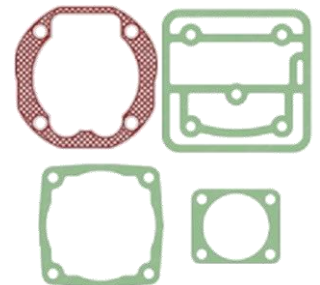

OEM Ref.

218.150

Crankcase



OEM Ref.

218.400

Valve Kit



OEM Ref.

107.450

Connecting Rod



OEM Ref. 000 131 18 17 / 000 130 19 16
000 130 25 17 / I80110 / I60599

107.700

Cylinder Liner Kit



OEM Ref. I808640061

107.720

Cylinder Liner



OEM Ref. 000 131 42 02
C63059

107.750

Bushing



OEM Ref. 000 131 31 50
B44935

107.500

Ø 88,00 mm

Piston

107.510

Ø 88,25 mm

10.520

Ø 88,50 mm



OEM Ref.

107.550

Ø 88,00 mm

Piston & Ring

107.560

Ø 88,25 mm

107.570

Ø 88,50 mm



OEM Ref. 000 130 11 17
411 042 620 2

107.600

Ø 88,00 mm

Ring

107.610

Ø 88,25 mm

107.620

Ø 88,50 mm



OEM Ref. 001 131 06 11
I139526F0061

107.800

Crankshaft



OEM Ref. 000 131 46 16 / 000 131 59 16 / 000 131 60 16

107.830

Crankshaft Flange



OEM Ref.

207.760

Roller Bearing



OEM Ref.

ASEL CODE

219.100

OEM Reference

LP3993 / K001611 / LK3960 / II402278F / 51 54100 7080 / 51 54101 7225

**Kullanılan Araç
Vehicle Application**

M 2000



Technical Data

Cylinder Bore	Ø 88.00 mm
Swept Volume	300 cc
Stroke	50 mm

212.200

Complete Cylinder Head



OEM Ref. ZB5275
I90153004 / I93078004

208.210

Cylinder Head



OEM Ref. STW63970

212.250

Plate

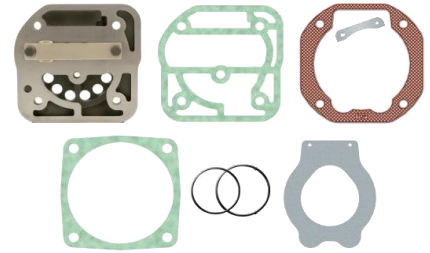

OEM Ref. I880570061

219.300

Full Repair Kit

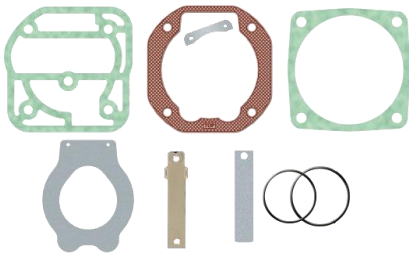

OEM Ref.

219.320

Repair Kit

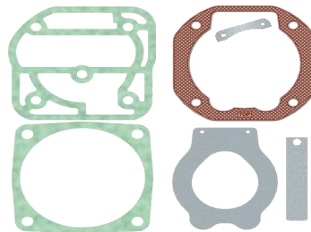

OEM Ref.

219.350

Gasket Kit

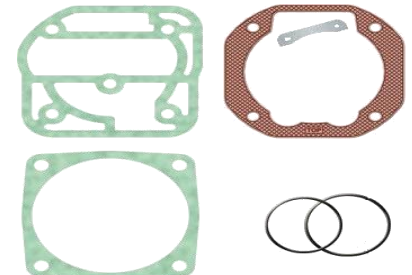

OEM Ref.

218.150

Crankcase



OEM Ref.

107.450

Connecting Rod



OEM Ref. 000 131 18 17 / 000 130 19 16
000 130 25 17 / I80110 / I60599

212.400

Valf Kit



OEM Ref.

212.700

Cylinder Liner Kit



OEM Ref. 81.54105-6009
I789790061

212.720

Cylinder Liner



OEM Ref. 81.54105-0024

107.750

Bushing



OEM Ref. 000 131 31 50
B44935

107.500

Ø 88,00 mm

Piston

107.510

Ø 88,25 mm

10.520

Ø 88,50 mm



OEM Ref.

107.550

Ø 88,00 mm

Piston & Ring

107.560

Ø 88,25 mm

107.570

Ø 88,50 mm



OEM Ref. 000 130 11 17
411 042 620 2

107.600

Ø 88,00 mm

Ring

107.610

Ø 88,25 mm

107.620

Ø 88,50 mm



OEM Ref. 81.54103-6000
001 131 06 11 / I139526F0061 / I811690062

212.800

Crankshaft



OEM Ref.

107.830

Crankshaft Flange



OEM Ref.

219.760

Roller Bearing



OEM Ref.

ASEL CODE	220.100
OEM Reference	LK1506 / LP1580 / 51.54101-7125
Kullanılan Araç Vehicle Application	MAN



Technical Data	
Cylinder Bore	Ø 75.00 mm
Swept Volume	155 cc
Stroke	35 mm

109.200 Complete Cylinder Head

OEM Ref. STW63841

109.210 Cylinder Head

OEM Ref 000 131 27 1
1138602F004

109.250 Plate

OEM Ref. 000 130 49 20
1138717F004 / 180408-004

109.300 Full Repair Kit

OEM Ref.

109.320 Repair Kit

OEM Ref.

109.350 Gasket Kit

OEM Ref.

109.150 Crankcase

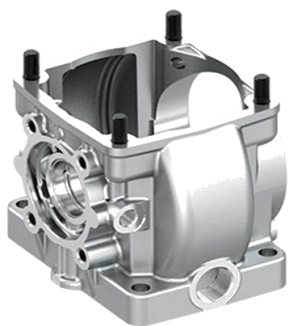

OEM Ref.

109.400 Valve Kit

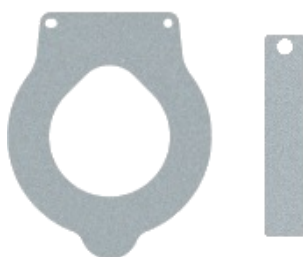

OEM Ref.

107.450 Connecting Rod



OEM Ref. 000 131 18 17 / 000 130 19 16
000 130 25 17 / I80110 / I60599

109.700 Cylinder Liner Kit



OEM Ref. 000 131 42 02
ZB4265 / I177246

109.720 Cylinder Liner



OEM Ref. 000 131 34 02

107.750 Bushing



OEM Ref. 000 131 31 50
B44935

109.500 Ø 75,00 mm Piston



OEM Ref.

109.550 Ø 75,00 mm Piston & Ring



OEM Ref. SEB22539 / SEB22540

109.600 Ø 75,00 mm Ring



OEM Ref. I801770061

109.510 Ø 75,25mm

109.560 Ø 75,25mm

109.610 Ø 75,25mm

109.520 Ø 75,50mm

109.570 Ø 75,50mm

109.620 Ø 75,50mm

220.800 Crankshaft



OEM Ref.

220.830 Crankshaft Flange



OEM Ref. B70756
I1152040069 / I86897

ASEL CODE

221.100

OEM Reference

LP 8106 / 51.54101-7084

**Kullanılan Araç
Vehicle Application**

OPTARE / ALERO



Technical Data

Cylinder Bore	Ø 88.00 mm
Swept Volume	225 cc
Stroke	37 mm

221.200

Complete Cylinder Head



OEM Ref.

221.210

Cylinder Head



OEM Ref.

107.250

Plate

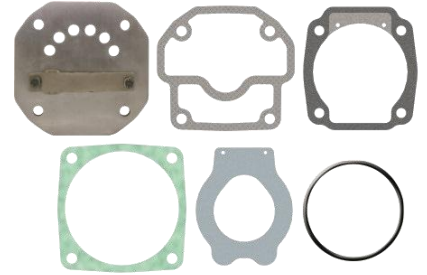

OEM Ref. 000 130 71 20
I138714F004 / I80398004

107.300

Full Repair Kit

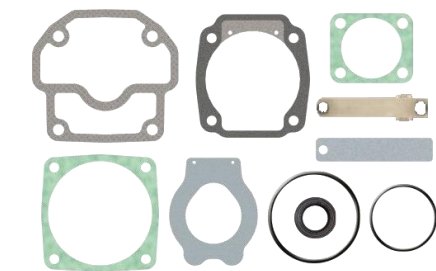

OEM Ref.

107.320

Repair Kit

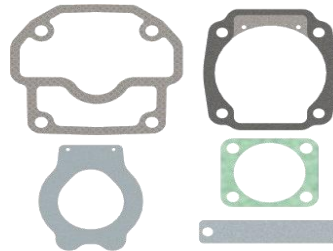

OEM Ref. STW63784

107.350

Gasket Kit

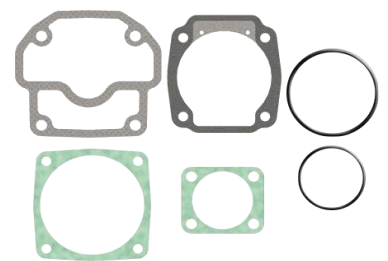

OEM Ref.

218.150

Crankcase



OEM Ref.

107.400

Valve Kit



OEM Ref.

107.450

Connecting Rod



OEM Ref. 000 131 18 17 / 000 130 19 16
000 130 25 17 / I80110 / I60599

107.700

Cylinder Liner Kit



OEM Ref. I808640061

107.720

Cylinder Liner



OEM Ref. 000 131 42 02
C63059

107.750

Bushing



OEM Ref. 000 131 31 50
B44935

107.500

Ø 88,00 mm

Piston

107.550

Ø 88,00 mm

Piston & Ring

107.600

Ø 88,00 mm

Ring

107.510

Ø 88,25 mm

107.560

Ø 88,25 mm

107.610

Ø 88,25 mm

10.520

Ø 88,50 mm

107.570

Ø 88,50 mm

107.620

Ø 88,50 mm



OEM Ref.



OEM Ref. 000 130 11 17
411 042 620 2



OEM Ref. 001 131 06 11
I139526F0061

221.800

Crankshaft



OEM Ref. 000 131 46 16

220.830

Crankshaft Flange



OEM Ref. B70756
I1152040069 / I86897

ASEL CODE

223.100

OEM Reference

51.54100-7069 / 51.54100-9069 / K001998 / K095873N04 / K0955873N00 / LK4939

**Kullanılan Araç
Vehicle Application**

TCV BUS / 18.220



Technical Data

Cylinder Bore	Ø 88.00 mm
Swept Volume	608 cc
Stroke	50 mm

223.200

Complete Cylinder Head



OEM Ref.

223.210

Cylinder Head



OEM Ref.

223.250

Plate

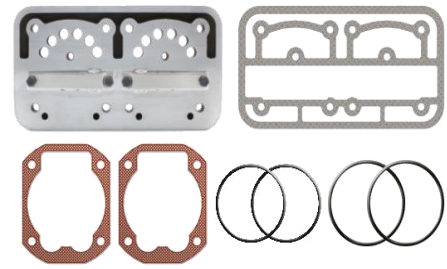

OEM Ref. 81.54124-6029
1117974004

223.300

Full Repair Kit

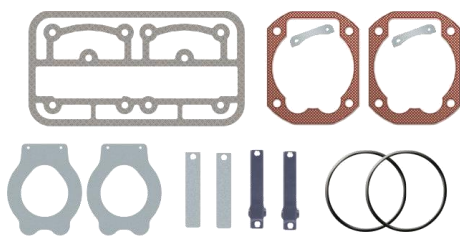

OEM Ref.

223.320

Repair Kit

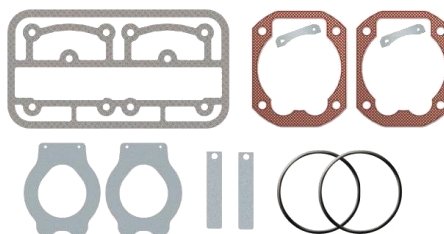

OEM Ref.

223.350

Gasket Kit

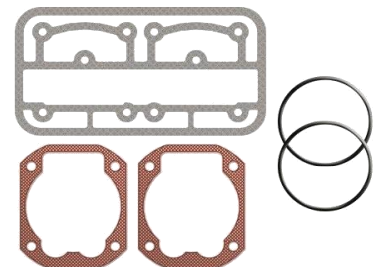

OEM Ref.

223.150

Crankcase

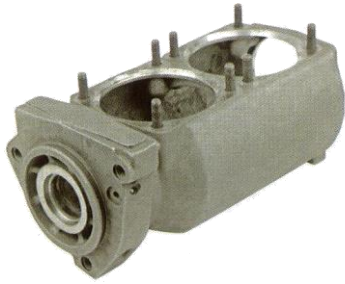

OEM Ref.

223.400

Valve Kit



OEM Ref. II179740061

107.450

Connecting Rod



OEM Ref. 000 131 18 17 / 000 130 19 16
000 130 25 17 / I80110 / I60599

223.700

Cylinder Liner Kit



OEM Ref. 51.54119-6003

223.720

Cylinder Liner



OEM Ref. 81.54105-0025 / 81.54105-0026

223.750

Bushing



OEM Ref.

107.500

Ø 88,00 mm

Piston

107.510

Ø 88,25 mm

10.520

Ø 88,50 mm



OEM Ref.

107.550

Ø 88,00 mm

Piston & Ring

107.560

Ø 88,25 mm

107.570

Ø 88,50 mm



OEM Ref. 000 130 11 17
411 042 620 2

107.600

Ø 88,00 mm

Ring

107.610

Ø 88,25 mm

107.620

Ø 88,50 mm



OEM Ref. 001 131 06 11
II39526F0061

223.800

Crankshaft



OEM Ref.

223.820

Gear



OEM Ref. 51.54210-0205

223.830

Crankshaft Flange



OEM Ref. SEB01691

ASEL CODE

223.110

OEM Reference

51.54101-7215 / 51.54101-9215 / LK4931 / II40277F

**Kullanılan Araç
Vehicle Application**

M 2000 / L 2000 / BUS



Technical Data

Cylinder Bore	Ø 88.00 mm
Swept Volume	608 cc
Stroke	50 mm

223.200

Complete Cylinder Head



OEM Ref.

223.210

Cylinder Head



OEM Ref.

223.250

Plate

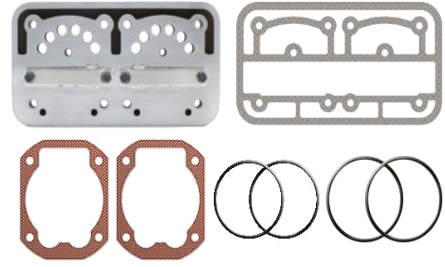

OEM Ref. 81.54124-6029
II17974004

223.300

Full Repair Kit

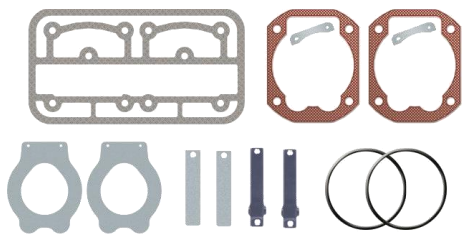

OEM Ref.

223.320

Repair Kit

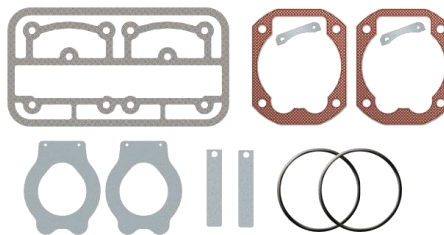

OEM Ref.

223.350

Gasket Kit

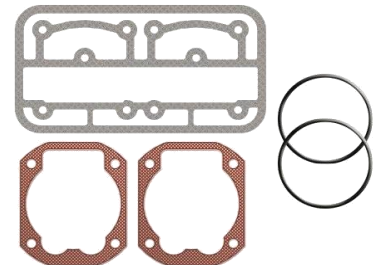

OEM Ref.

223.160

Crankcase



OEM Ref.

223.400

Valve Kit



OEM Ref. II179740061

107.450

Connecting Rod



OEM Ref. 000 131 18 17 / 000 130 19 16
000 130 25 17 / I80110 / I60599

223.700

Cylinder Liner Kit



OEM Ref. 51.54119-6003

223.720

Cylinder Liner



OEM Ref. 81.54105-0025 / 81.54105-0026

223.760

Bushing



OEM Ref.

107.500

Ø 88,00 mm

Piston

107.510

Ø 88,25 mm

10.520

Ø 88,50 mm



OEM Ref.

107.550

Ø 88,00 mm

Piston & Ring

107.560

Ø 88,25 mm

107.570

Ø 88,50 mm



OEM Ref. 000 130 11 17
411 042 620 2

107.600

Ø 88,00 mm

Ring

107.610

Ø 88,25 mm

107.620

Ø 88,50 mm



OEM Ref. 001 131 06 11
II39526F0061

223.810

Crankshaft



OEM Ref.

223.825

Gear



OEM Ref. 51.54210-0109

223.840

Crankshaft Flange



OEM Ref.

ASEL CODE

224.100

OEM Reference

51.54100-7115 / 51.54100-7197 / 51.54100-7228 / 51.54100-7249
LK4960 / K015108 / K089063N00 / K089063N04 / K118706N04

**Kullanılan Araç
Vehicle Application**

TGA / TGX / TGS / TGM / D2066 ENGINE / CENTROLINER / CITYLINER / TOURLINER / LIONS
COACH / LIONS CITY / LIONS REGIO

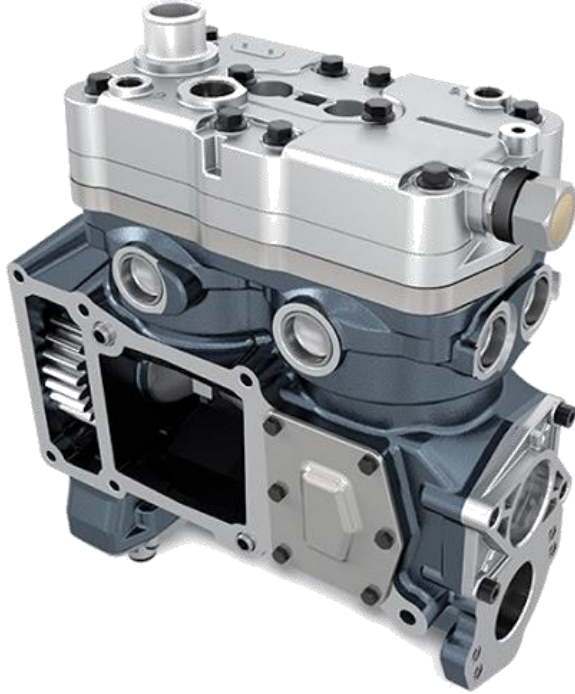

Technical Data

Cylinder Bore	Ø 92.00 mm
Swept Volume	720 cc
Stroke	54 mm

224.200

Complete Cylinder Head

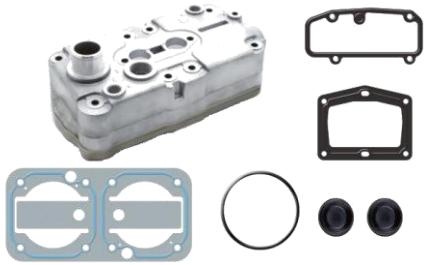

OEM Ref.

224.210

Cylinder Head

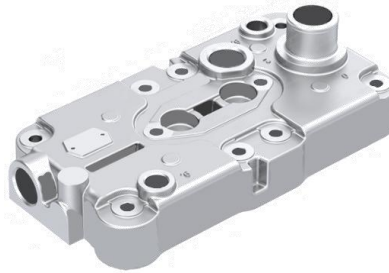

OEM Ref. SEB01903004

224.250

Plate

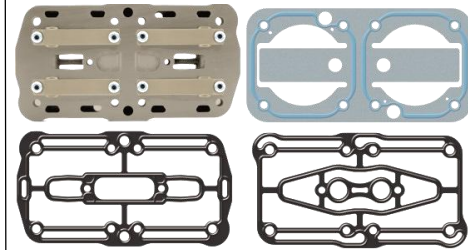

OEM Ref. 51.54124-6005
K019525

224.270

Cooling Plate



OEM Ref.

224.300

Full Repair Kit

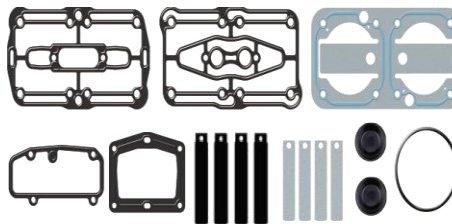

OEM Ref.

224.320

Repair Kit

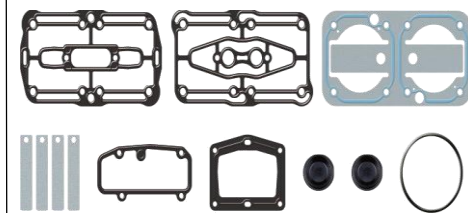

OEM Ref.

224.350 **Gasket Kit**

OEM Ref.

214.400 **Valve Kit**

OEM Ref.

224.150 **Crankcase**

OEM Ref.

224.450 **Connecting Rod**

OEM Ref.

224.800 **Crankshaft**

OEM Ref.

214.750 **Bushing**

OEM Ref.

214.500 **Ø 92,00 mm** **Piston**

214.510 **Ø 92,25 mm**

214.520 **Ø 92,50 mm**

OEM Ref.

214.550 **Ø 92,00 mm** **Piston & Ring**

214.560 **Ø 92,25 mm**

214.570 **Ø 92,50 mm**

OEM Ref. 51.54119-6008 / 51.54119-6009
K006026 / K012079 / K012079K56 / SEB22530

214.600 **Ø 92,00 mm** **Ring**

214.610 **Ø 92,25 mm**

214.620 **Ø 92,50 mm**

OEM Ref.

224.810 **Drive Shaft**

OEM Ref.

214.820 **Gear**

OEM Ref.

214.825 **Gear**

OEM Ref.

214.160 **Cover**

OEM Ref.

224.160 **Cover**

OEM Ref.

ASEL CODE

224.110

OEM Reference

51.54100-7024 / 51.54100-7114 51.54100-7196 / 51.54100-7227 / 51.54100-7248
K088948N04 / LK4928 / K015965

**Kullanılan Araç
Vehicle Application**

TGA / TGX / TGS / TGM / D2066 ENGINE / CENTROLINER / CITYLINER / TOURLINER
LIONS COACH / LIONS CITY / LIONS REGIO

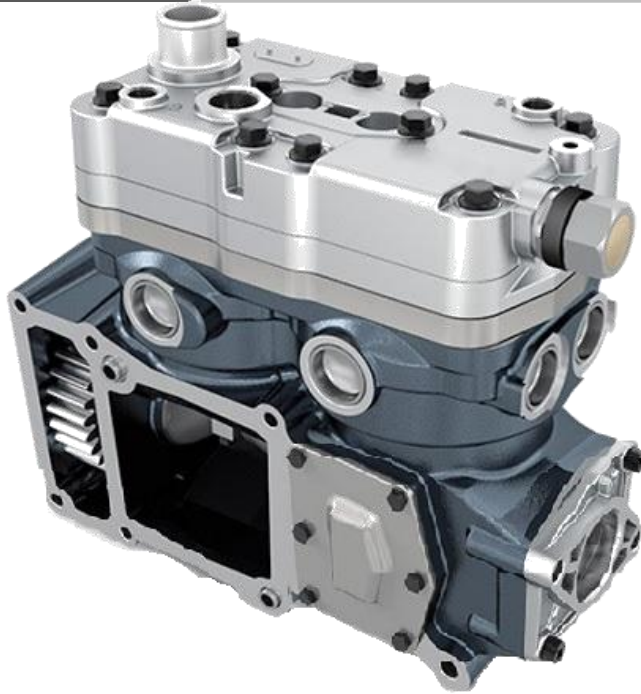

Technical Data

Cylinder Bore	Ø 92.00 mm
Swept Volume	720 cc
Stroke	54 mm

224.200

Complete Cylinder Head

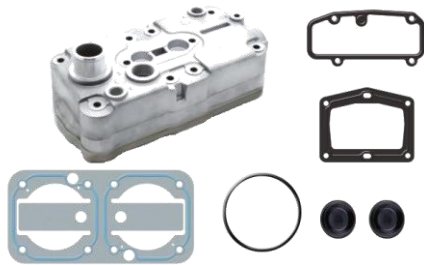

OEM Ref.

224.210

Cylinder Head

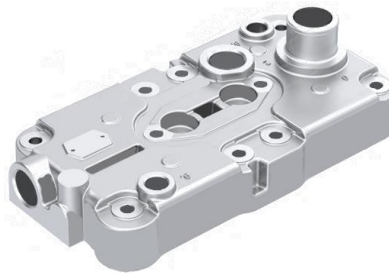

OEM Ref SEB01903004

224.250

Plate

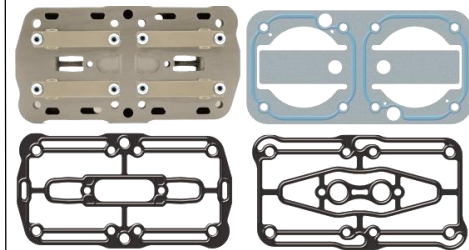

OEM Ref. 51.54124-6005
K019525

224.270

Cooling Plate



OEM Ref.

224.300

Full Repair Kit

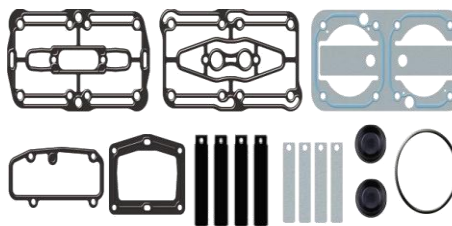

OEM Ref.

224.320

Repair Kit

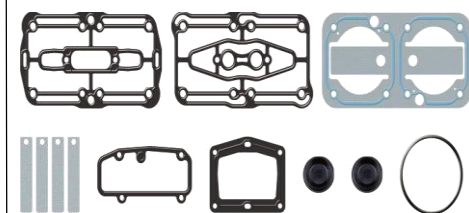

OEM Ref.

224.350

Gasket Kit

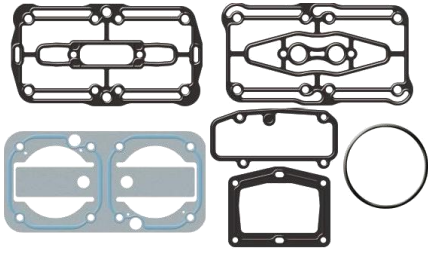

OEM Ref.

214.400

Valve Kit

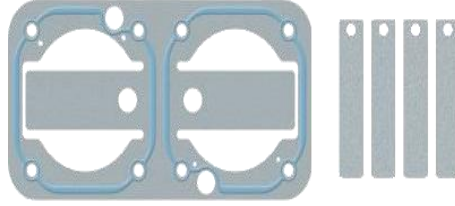

OEM Ref.

224.160

Crankcase



OEM Ref.

224.450

Connecting Rod



OEM Ref.

214.750

Bushing



OEM Ref.

224.800

Crankshaft



OEM Ref.

214.500

Ø 92,00 mm

Piston

214.510

Ø 92,25 mm

214.520

Ø 92,50 mm



OEM Ref.

214.550

Ø 92,00 mm

Piston & Ring

214.560

Ø 92,25 mm

214.570

Ø 92,50 mm



OEM Ref. 51.54119-6008 / 51.54119-6009
K006026 / K012079 / K012079K56 / SEB22530

214.600

Ø 92,00 mm

Ring

214.610

Ø 92,25 mm

214.620

Ø 92,50 mm



OEM Ref.

224.160

Cover



OEM Ref.

214.820

Gear



OEM Ref.

214.830

Crankshaft Flange



OEM Ref.

ASEL CODE	225.100
OEM Reference	LP490 TYPE / 51.54100-7258
Kullanılan Araç Vehicle Application	LION S CITY / LION S REGIO / BUS / EURO 6



Technical Data	
Cylinder Bore	∅ 92 – 60 mm
Swept Volume	490 cc
Stroke	60 / 30 mm

225.200 Complete Cylinder Head

OEM Ref. 51.54100-6055 / 51.54901-6008
14900138310 / 14900138410

225.210 Cylinder Head

OEM Ref.

129.250 Plate

OEM Ref.

225.270 Cooling Plate

OEM Ref.

129.300 Full Repair Kit

OEM Ref.

129.320 Repair Kit

OEM Ref.

129.350 **Gasket Kit**

OEM Ref.

129.400 **Valve Kit**

OEM Ref.

129.450 **Connecting Rod**

OEM Ref.

129.460 **Connecting Rod**

OEM Ref.

225.750 **Bushing**

OEM Ref.

225.800 **Crankshaft**

OEM Ref.

129.500 **∅ 92,00 mm** **Piston**

129.510 **∅ 92,25 mm**

129.520 **∅ 92,50 mm**

OEM Ref. 149000305 2,50*2,50*3,00

129.550 **∅ 92,00 mm** **Piston & Ring**

129.560 **∅ 92,25 mm**

129.570 **∅ 92,50 mm**

OEM Ref. 2,50*2,50*3,00

129.600 **∅ 92,00 mm** **Ring**

129.610 **∅ 92,25 mm**

129.620 **∅ 92,50 mm**

OEM Ref. 2,50*2,50*3,00

129.505 **∅ 60,00 mm**

129.515 **∅ 60,25 mm**

129.525 **∅ 60,50 mm**

OEM Ref. 14900025920 2,00*2,00*3,00

129.555 **∅ 60,00 mm**

129.565 **∅ 60,25 mm**

129.575 **∅ 60,50 mm**

OEM Ref. 2,00*2,00*3,00

129.605 **∅ 60,00 mm**

129.615 **∅ 60,25 mm**

129.625 **∅ 60,50 mm**

OEM Ref. 2,00*2,00*3,00

223.820 **Gear**

OEM Ref. 51.54210-0205

225.830 **Crankshaft Flange**

OEM Ref.



KOMPRESÖR YEDEK PARÇALARI
COMPRESSOR SPARE PARTS

İÇİNDEKİLER / INDEX

Sayfa No / Page No

FORD

<u>CARGO 2520</u>	<u>131</u>
<u>CARGO 2524 / 2526 / 2520 L / 1826</u>	<u>132-133</u>
<u>CARGO 3230 / 2532 / 3232</u>	<u>134-135</u>
<u>CARGO 3227</u>	<u>136-137</u>
<u>CARGO 1835 / 3235</u>	<u>138-139</u>
<u>CARGO 1835 / 3235 / 3238</u>	<u>140-141</u>

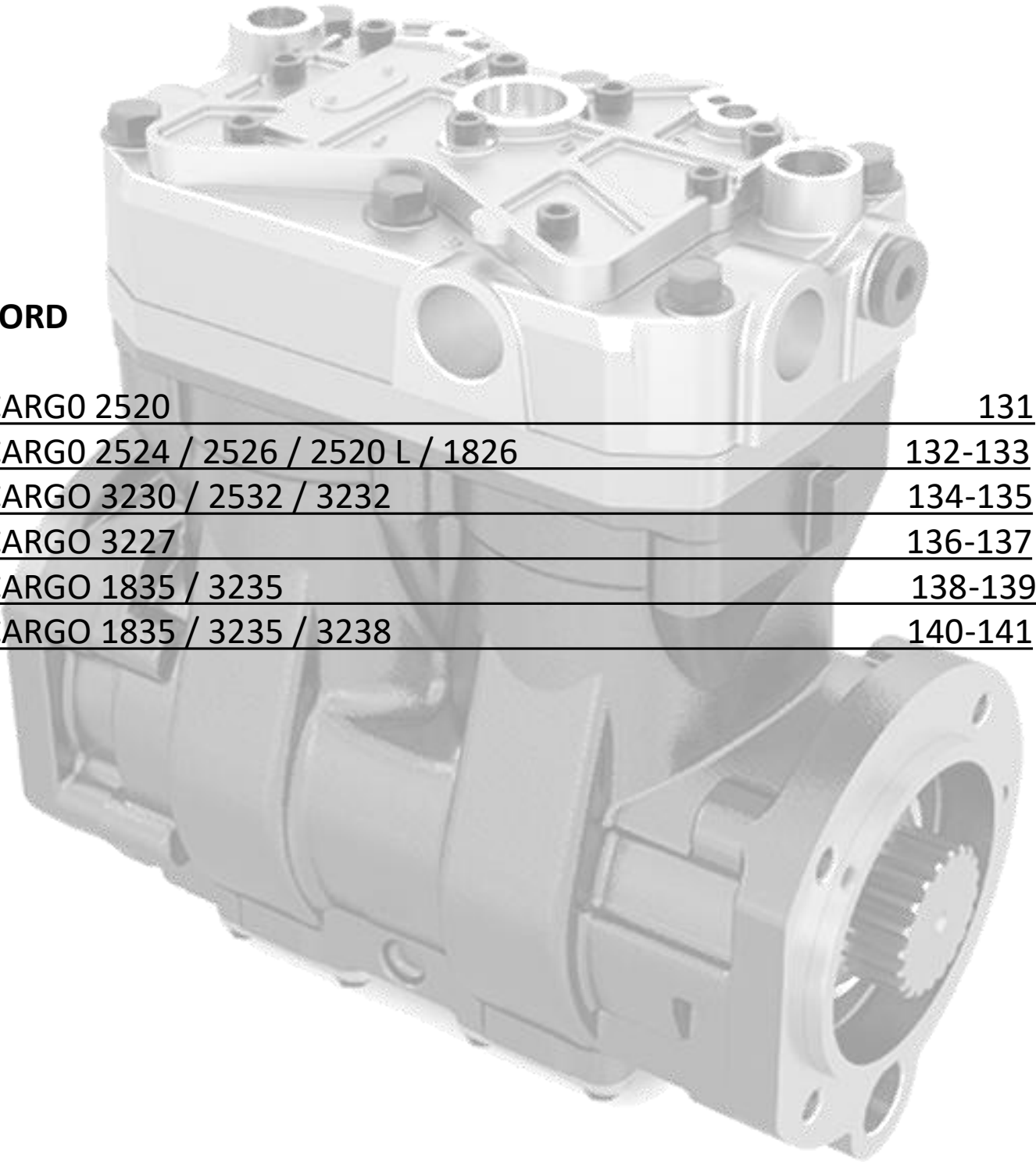

ASEL CODE

301.100

OEM Reference

KZ1143-1-3-4 / ARM2875 FDN

Kullanılan Araç
Vehicle Application

CARGO 2520



Technical Data

Cylinder Bore	Ø 85.72 mm
Swept Volume	250 cc

301.200

Complete Cylinder Head



OEM Ref.

301.250

Plate

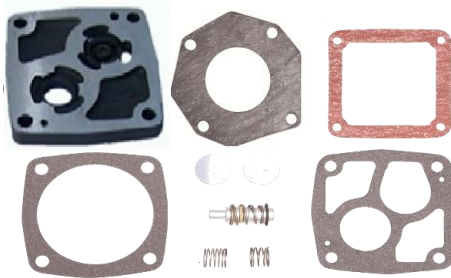

OEM Ref.

301.300

Full Repair Kit

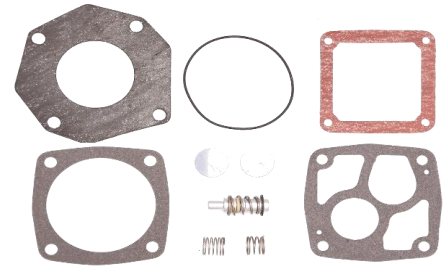

OEM Ref.

301.320

Repair Kit

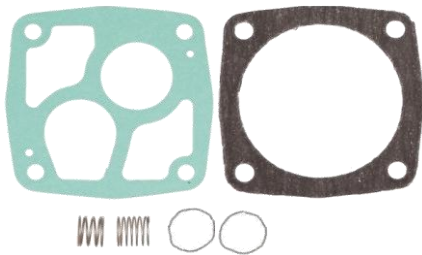

OEM Ref.

301.350

Gasket Kit

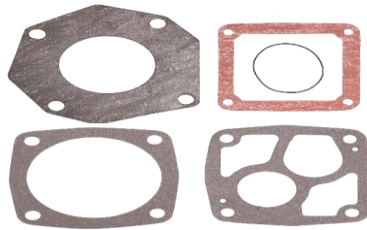









OEM Ref.

301.400

Valve Kit



OEM Ref.

ASEL CODE

302.100

OEM Reference

LK3848 / LK3854 / 7C46 2875 CA / SEB01799

**Kullanılan Araç
Vehicle Application**

CARGO 2524 / 2526 / 2520 L / 1826

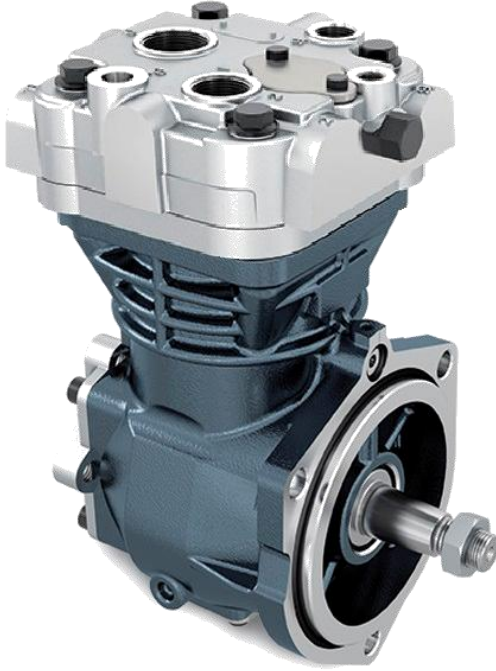

Technical Data

Cylinder Bore	Ø 80.00 mm
Swept Volume	225 cc
Stroke	45 mm

302.200

Complete Cylinder Head



OEM Ref.

302.210

Cylinder Head



OEM Ref. SEB01763004

302.250

Plate



OEM Ref. SEB01593004 / 9P918391

302.300

Full Repair Kit



OEM Ref.

302.310

Repair Kit

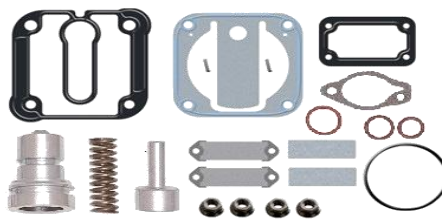

OEM Ref. SEB22519 / 9P918389

302.320

Repair Kit

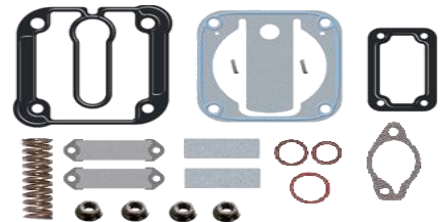

OEM Ref.

302.330 **Repair Kit**

OEM Ref. SEB22461

302.350 **Gasket Kit**

OEM Ref.

302.150 **Crankcase**

OEM Ref.

302.400 **Valve Kit**

OEM Ref.

302.410 **Valve Kit**

OEM Ref.

302.450 **Connecting Rod**

OEM Ref.

302.500 **Ø 80,00 mm** **Piston**

302.510 **Ø 85,25 mm**

302.520 **Ø 85,50 mm**

OEM Ref.

302.550 **Ø 80,00 mm** **Piston & Ring**

302.560 **Ø 80,25 mm**

302.570 **Ø 80,50 mm**

OEM Ref.

302.600 **Ø 80,00 mm** **Ring**

302.610 **Ø 80,25 mm**

302.620 **Ø 80,50 mm**

OEM Ref. SEB22517

302.750 **Bushing**

OEM Ref.

302.800 **Crankshaft**

OEM Ref.

302.830 **Crankshaft Flange**

OEM Ref.

ASEL CODE**303.100****OEM Reference**

LP3974 / K017428 / 7C46 2875 BA

**Kullanılan Araç
Vehicle Application**

CARGO 3230 / 2532 / 3232

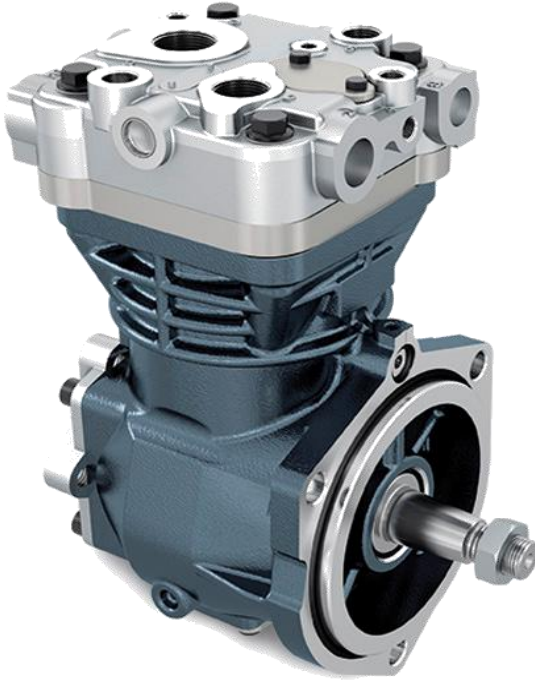
**Technical Data**

Cylinder Bore	Ø 92.00 mm
Swept Volume	360 cc
Stroke	54 mm

303.200**Complete Cylinder Head**

OEM Ref.

303.210**Cylinder Head**

OEM Ref. 4C4628960AA / SEB01894004

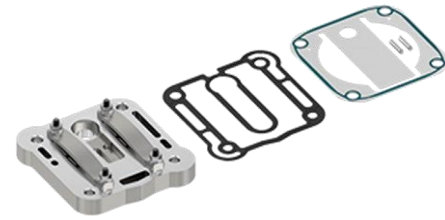
303.250**Plate**

OEM Ref. 42471272 / Y00452004

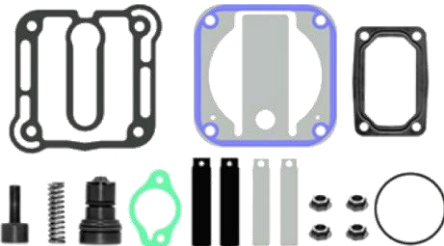
303.300**Full Repair Kit**

OEM Ref.

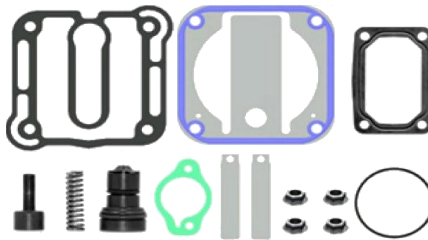
303.310**Repair Kit**

OEM Ref. 4C462B956AA / SEB2597

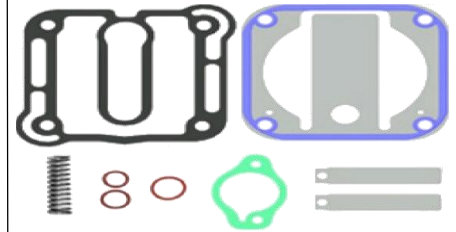
303.320**Repair Kit**

OEM Ref. 4C462B956BA / SEB22532

303.330 Repair Kit

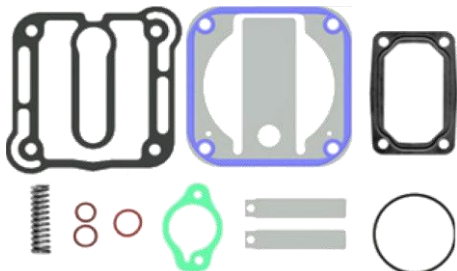

OEM Ref.

303.350 Gasket Kit

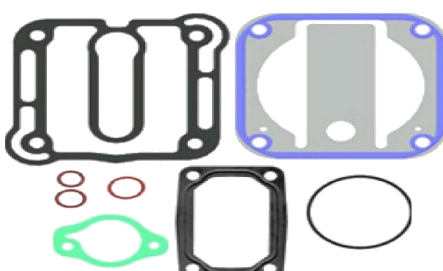

OEM Ref.

303.150 Crankcase



OEM Ref.

303.400 Valve Kit

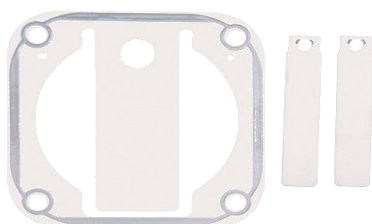

OEM Ref.

302.410 Valve Kit



OEM Ref.

214.450 Connecting Rod



OEM Ref. SEB22464 / EB02800

214.500 Ø 92,00 mm Piston



OEM Ref.

214.550 Ø 92,00 mm Piston & Ring



OEM Ref. 51.54119-6008 / 51.54119-6009
K006026 / K012079 / K012079K56 / SEB22530

214.600 Ø 92,00 mm Ring



OEM Ref.

214.510 Ø 92,25 mm

214.560 Ø 92,25 mm

214.610 Ø 92,25 mm

214.520 Ø 92,50 mm

214.570 Ø 92,50 mm

214.620 Ø 92,50 mm

214.750 Bushing



OEM Ref.

303.800 Crankshaft

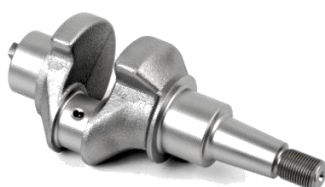

OEM Ref.

302.830 Crankshaft Flange



OEM Ref.

ASEL CODE

304.100

OEM Reference

LK3965 / YTC 2875 AA / II33163

**Kullanılan Araç
Vehicle Application**

CARGO 3227



Technical Data

Cylinder Bore	Ø 88.00 mm
Swept Volume	300 cc
Stroke	50 mm

304.200

Complete Cylinder Head



OEM Ref.

304.210

Cylinder Head



OEM

304.250

Plate

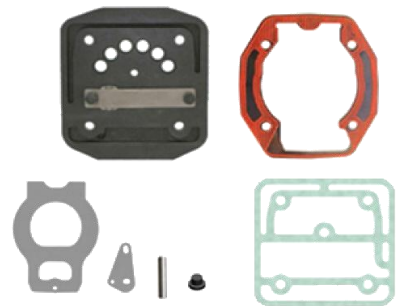

OEM Ref.

304.300

Full Repair Kit



OEM Ref.

304.310

Repair Kit

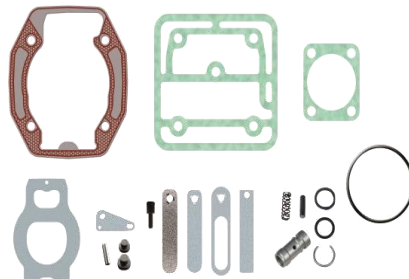

OEM Ref.

304.320

Repair Kit

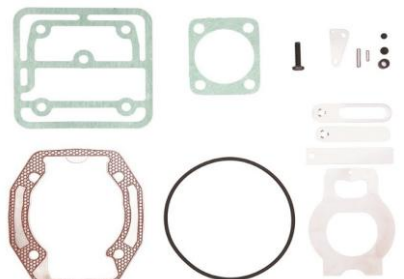

OEM Ref.

304.350 Gasket Kit

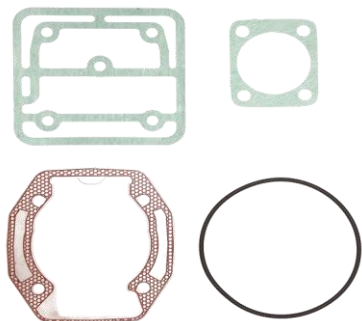

OEM Ref.

304.400 Valve Kit



OEM Ref.

304.410 Valve Kit



OEM Ref.

304.150 Crankcase



OEM Ref.

212.450 Connecting Rod



OEM Ref.

107.500 Ø 88,00 mm Piston

107.510 Ø 88,25 mm

107.520 Ø 88,50 mm



OEM Ref.

107.550 Ø 88,00 mm Piston & Ring

107.560 Ø 88,25 mm

107.570 Ø 88,50 mm



OEM Ref. I81169004 / SEB22555

107.600 Ø 88,00 mm Ring

107.610 Ø 88,25 mm

107.620 Ø 88,50 mm



OEM Ref. II39526F0061

304.700 Cylinder Liner Set



OEM Ref. K000998

304.720 Cylinder Liner



OEM Ref.

304.750 Bushing



OEM Ref.

304.800 Crankshaft



OEM Ref.

ASEL CODE	305.100
OEM Reference	LK4958 / K013739ES / 7C46 2875 AD
Kullanılan Araç Vehicle Application	CARGO 1835 / 3235

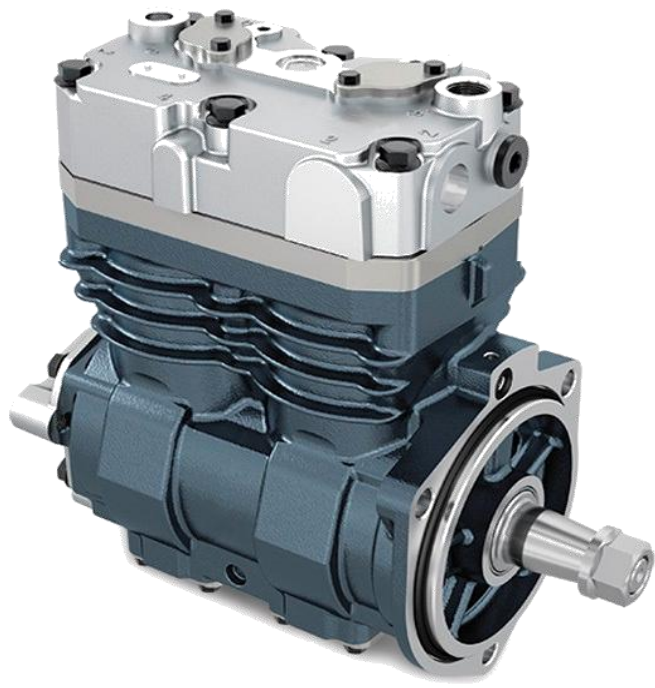

Technical Data	
Cylinder Bore	Ø 86.00 mm
Swept Volume	630 cc
Stroke	54 mm

305.200 Complete Cylinder Head



OEM Ref.

305.210 Cylinder Head



OEM Ref.

305.250 Plate



OEM Ref. SEB01878004

305.300 Full Repair Kit



OEM Ref. SEB22549 / 42549150

305.310 Repair Kit



OEM Ref.

305.320 Repair Kit



OEM Ref.

305.350 **Gasket Kit**

OEM Ref.

305.400 **Valve Kit**

OEM Ref.

305.410 **Valve Kit**

OEM Ref.

305.150 **Crankcase**

OEM Ref.

305.160 **Cover**

OEM Ref.

214.450 **Connecting Rod**

OEM Ref. SEB22464 / EB02800

124.500 **Ø 86,00 mm** **Piston**

124.510 **Ø 86,25 mm**

124.520 **Ø 86,50 mm**

OEM Ref.

124.550 **Ø 86,00 mm** **Piston & Ring**

124.560 **Ø 86,25 mm**

124.570 **Ø 86,50 mm**

OEM Ref. SEB22547 / SEB22548 / 42549147

124.600 **Ø 86,00 mm** **Ring**

124.610 **Ø 86,25 mm**

124.620 **Ø 86,50 mm**

OEM Ref.

305.750 **Bushing**

OEM Ref.

305.800 **Crankshaft**

OEM Ref.

305.830 **Crankshaft Flange**

OEM Ref.

ASEL CODE

306.100

OEM Reference

LK4958 / K013739 / 7C46 2875 ADN

**Kullanılan Araç
Vehicle Application**

CARGO 1835 / 3235 / 3238

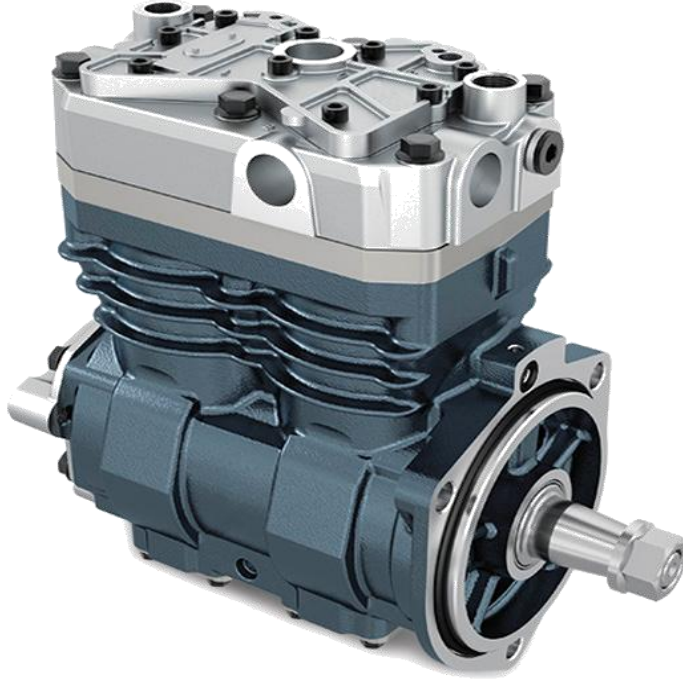

Technical Data

Cylinder Bore	Ø 86.00 mm
Swept Volume	630 cc
Stroke	54 mm

306.200

Complete Cylinder Head



OEM Ref.

306.210

Cylinder Head



OEM Ref. K094157K50

306.250

Plate

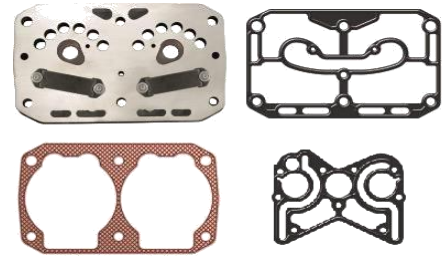

OEM Ref. 8C462B956AA / K041488K50

306.300

Full Repair Kit

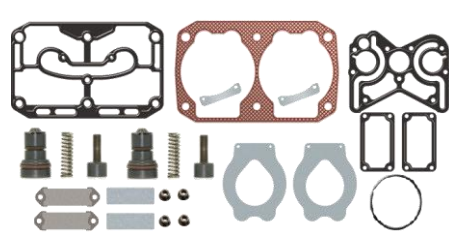

OEM Ref. SEB22549 / 42549150

306.310

Repair Kit

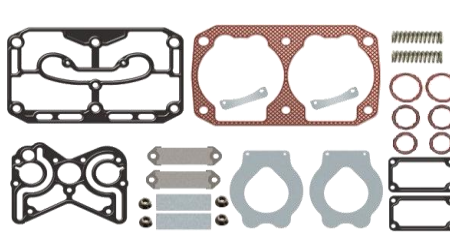

OEM Ref.

306.320

Repair Kit

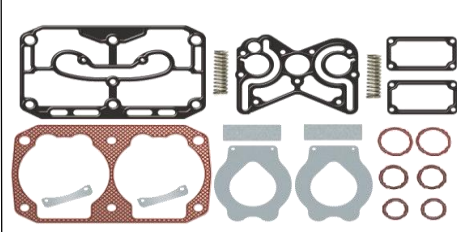

OEM Ref.

306.350 **Gasket Kit**



OEM Ref. SEB22550

305.400 **Valve Kit**



OEM Ref.

306.410 **Valve Kit**



OEM Ref.

305.150 **Crankcase**



OEM Ref.

305.160 **Cover**



OEM Ref.

214.450 **Connecting Rod**



OEM Ref. SEB22464 / EB02800

124.500 **Ø 86,00 mm** **Piston**

124.510 **Ø 86,25 mm**

124.520 **Ø 86,50 mm**



OEM Ref.

124.550 **Ø 86,00 mm** **Piston & Ring**

124.560 **Ø 86,25 mm**

124.570 **Ø 86,50 mm**



OEM Ref. SEB22547 / SEB22548 / 42549147

124.600 **Ø 86,00 mm** **Ring**

124.610 **Ø 86,25 mm**

124.620 **Ø 86,50 mm**



OEM Ref.

305.750 **Bushing**



OEM Ref.

305.800 **Crankshaft**



OEM Ref.

305.830 **Crankshaft Flange**



OEM Ref.



KOMPRESÖR YEDEK PARÇALARI
COMPRESSOR SPARE PARTS

İÇİNDEKİLER / INDEX
Sayfa No / Page No

BMC	
FATİH 162 22 / 25	142
DEV FATİH	143
PRO 522 / 624 / PROBUS	144-145
PRO 822 / 827 / 832 / BELDE	146
PRO 935 / 940	147
PRO 1142 / 260 CB / BELDE	148
PRO 620 / PROBUS	149
PROCITY EURO 5 / TEMSA EURO 5	150-151
BELDE 260 CB EURO3	152-153
PROCITY / BELDE	154-155
PRO 1142 / PRO 1144	156-157

ASEL CODE**351.100****OEM Reference**

KZ929 / KZ 930 / KZ 931 / KZ 932 / KZ 960 / KZ961 / KZ 11443 / C 3906255

**Kullanılan Araç
Vehicle Application**

FATİH 162 22 - 25

**Technical Data**Cylinder Bore \varnothing 80. mm

Swept Volume 225 cc

351.200**Complete Cylinder Head**

OEM Ref.

351.250**Plate**

OEM Ref.

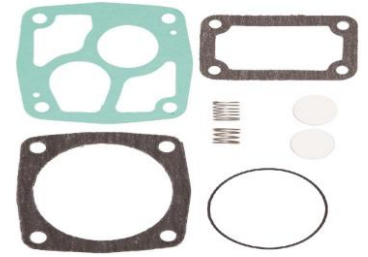
351.300**Full Repair Kit**

OEM Ref.

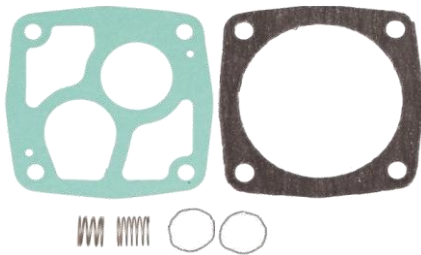
301.320**Repair Kit**

OEM Ref.

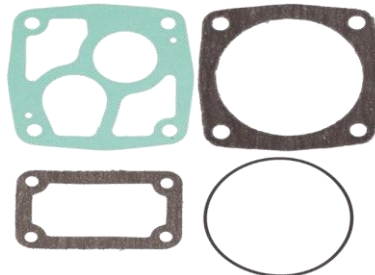
351.350**Gasket Kit**

OEM Ref.

351.400**Valve Kit**

OEM Ref.

ASEL CODE

352.100

OEM Reference

SS296C

Kullanılan Araç
Vehicle Application

DEV FATİH



Technical Data

Cylinder Bore	Ø 92.75. mm

352.200

Complete Cylinder Head



OEM Ref.

352.250

Plate



OEM Ref.

352.300

Full Repair Kit

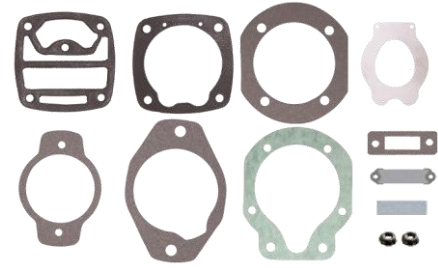

OEM Ref.

352.320

Repair Kit

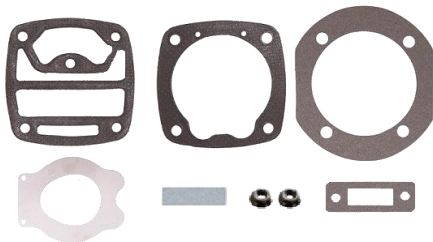

OEM Ref.

352.350

Gasket Kit

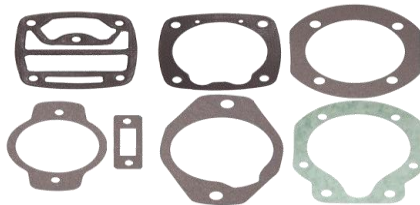

OEM Ref.

352.400

Valve Kit



OEM Ref.

ASEL CODE**354.100****OEM Reference**

LK3857 / 57R9300781

**Kullanılan Araç
Vehicle Application**

PRO 522 / 624 / PROBUS

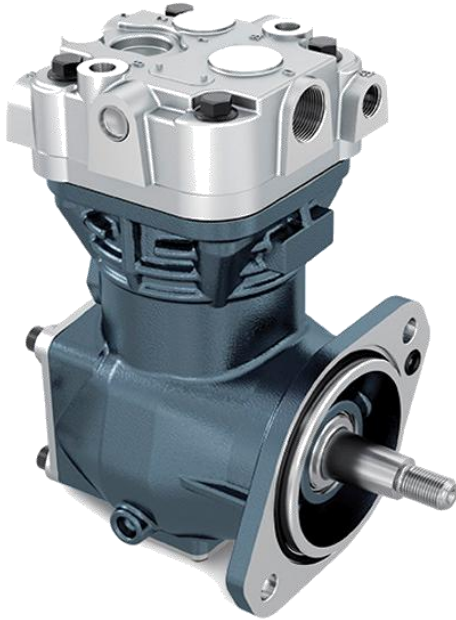
**Technical Data**

Cylinder Bore	Ø 80.00 mm
Swept Volume	255 cc
Stroke	45 mm

354.200**Complete Cylinder Head**

OEM Ref.

354.210**Cylinder Head**

OEM Ref.

302.250**Plate**

OEM Ref. SEB01593004 / 9P918391

302.300**Full Repair Kit**

OEM Ref.

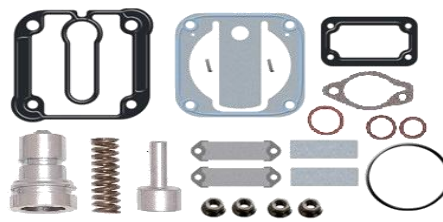
302.310**Repair Kit**

OEM Ref. SEB22519 / 9P918389

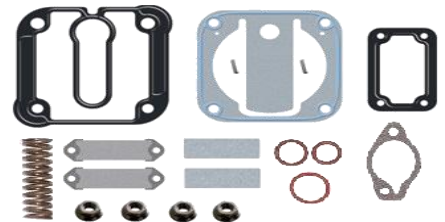
302.320**Repair Kit**

OEM Ref.

302.330 **Repair Kit**

OEM Ref. SEB22461

302.350 **Gasket Kit**

OEM Ref.

354.150 **Crankcase**

OEM Ref.

302.400 **Valve Kit**

OEM Ref.

302.410 **Valve Kit**

OEM Ref.

214.450 **Connecting Rod**

OEM Ref. SEB22464 / EB02800

302.500 **Ø 80,00 mm** **Piston**

302.510 **Ø 85,25 mm**

302.520 **Ø 85,50 mm**

OEM Ref.

302.550 **Ø 80,00 mm** **Piston & Ring**

302.560 **Ø 80,25 mm**

302.570 **Ø 80,50 mm**

OEM Ref.

302.600 **Ø 80,00 mm** **Ring**

302.610 **Ø 80,25 mm**

302.620 **Ø 80,50 mm**

OEM Ref. SEB22517

302.750 **Bushing**

OEM Ref.

354.800 **Crankshaft**

OEM Ref.

354.830 **Crankshaft Flange**

OEM Ref.

ASEL CODE	355.100
OEM Reference	TUFLO 550 / 2K97866M
Kullanılan Araç Vehicle Application	PRO 822 / 827 / 832 / BELDE



Technical Data	
Cylinder Bore	Ø 70.64 mm
Swept Volume	298 cc
Stroke	36 mm

355.200 Complete Cylinder Head

OEM Ref. 1070892 / 9P920283

355.310 Full Repair Kit

OEM Ref. 2K200296 / 107516

355.320 Full Repair Kit

OEM Ref.

355.350 Gasket Kit

OEM Ref.

355.400 Valve Kit

OEM Ref.

355.410 Valve Kit

OEM Ref.

ASEL CODE	356.100
OEM Reference	911 153 938 0 / 9P921823
Kullanılan Araç Vehicle Application	PRO 935 / 940



Technical Data	
Cylinder Bore	Ø 85.00 mm
Swept Volume	318 cc
Stroke	56 mm

356.200 Complete Cylinder Head

OEM Ref. 911 153 920 2

356.310 Full Repair Kit

OEM Ref.

356.320 Full Repair Kit

OEM Ref. 911 154 929 2

356.350 Gasket Kit

OEM Ref.

356.400 Valve Kit

OEM Ref.

101.550 Ø 85,00 mm Piston & Ring

101.560 Ø 85,25 mm

101.570 Ø 85,50 mm

OEM Ref. 911 501 624 2 / 911 501 625 2

ASEL CODE**357.100****OEM Reference**

LP4861 / K006610 / 9P92490

**Kullanılan Araç
Vehicle Application**

PRO 1142 / 260 CB / BELDE

**Technical Data**

Cylinder Bore	Ø 86.00 mm
Swept Volume	460 cc
Stroke	40 mm

357.200**Complete Cylinder Head**

OEM Ref.

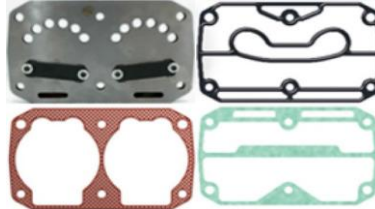
357.250**Plate**

OEM Ref. 1194256P / SEB01879004

357.300**Full Repair Kit**

OEM Ref.

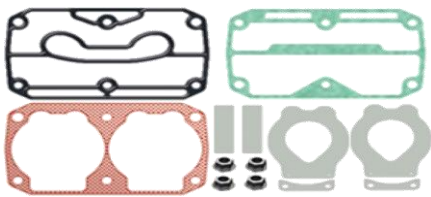
357.320**Repair Kit**

OEM Ref.

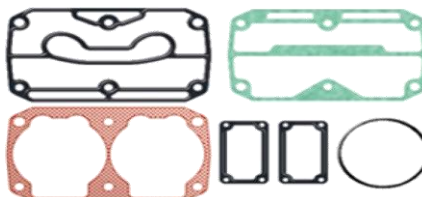
357.350**Gasket Kit**

OEM Ref.

305.400**Repair Kit**

OEM Ref.

ASEL CODE**358.100****OEM Reference**

LK3875 / K008457 / 9P920586

**Kullanılan Araç
Vehicle Application**

PRO620 / PROBUS

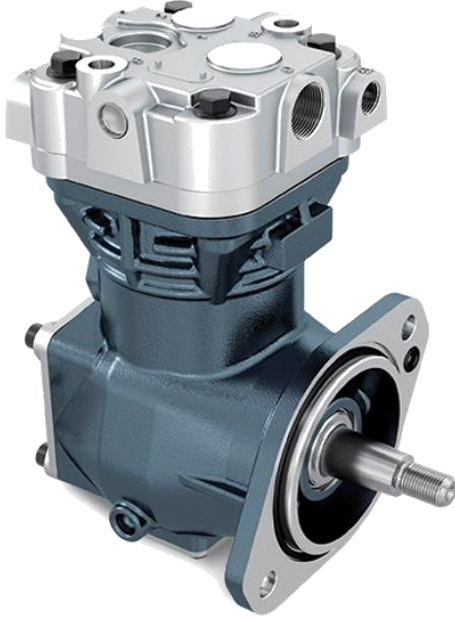
**Technical Data**

Cylinder Bore	Ø 80.00 mm
Swept Volume	225 cc

358.200**Complete Cylinder Head**

OEM Ref.

358.250**Cylinder Head**

OEM Ref.

358.250**Plate**

OEM Ref.

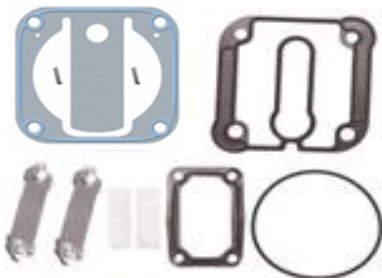
358.300**Full Repair Kit**

OEM Ref.

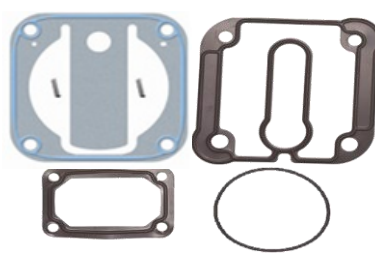
358.350**Gasket Kit**

OEM Ref.

305.400**Valve Kit**

OEM Ref.

ASEL CODE

359.100

OEM Reference

9P925474 / K033404N00 / LP4865

**Kullanılan Araç
Vehicle Application**

PROCITY EURO 5 / TEMSA EURO 5

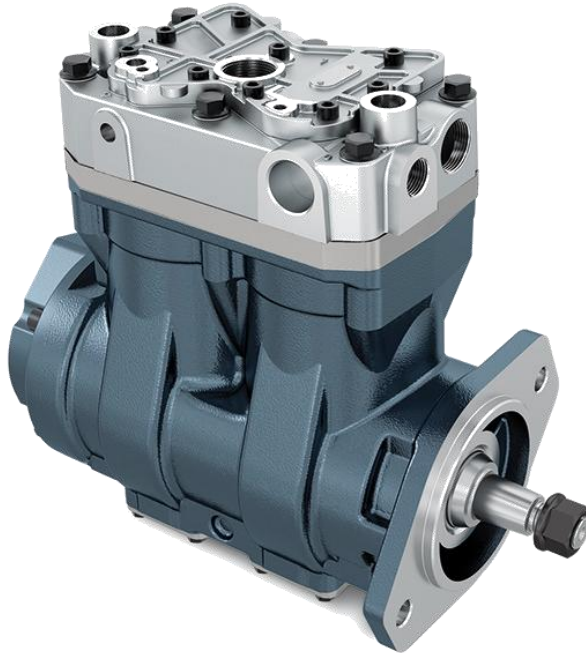

Technical Data

Cylinder Bore	Ø 86.00 mm
Swept Volume	460 cc
Stroke	40 mm

359.200

Complete Cylinder Head



OEM Ref.

359.210

Cylinder Head



OEM Ref. K047839K50

359.250

Plate

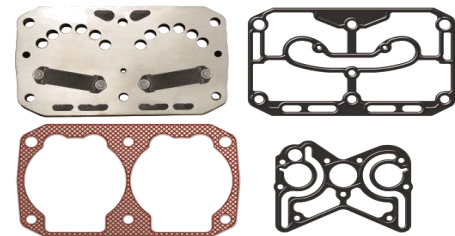

OEM Ref. K044410K50

359.300

Full Repair Kit



OEM Ref.

359.310

Repair Kit

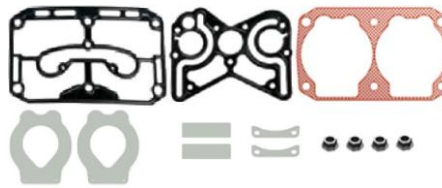

OEM Ref.

359.320

Repair Kit

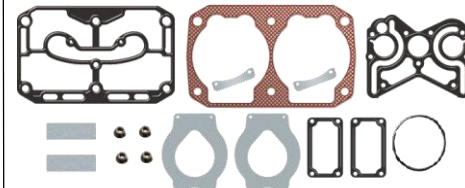

OEM Ref.

359.350 **Gasket Kit**

OEM Ref.

305.400 **Valve Kit**

OEM Ref.

359.150 **Crankcase**

OEM Ref.

305.160 **Cover**

OEM Ref.

359.165 **Cylinder Head Cover**

OEM Ref.

359.450 **Connecting Rod**

OEM Ref.

124.500 **Ø 86,00 mm** **Piston**

124.510 **Ø 86,25 mm**

124.520 **Ø 86,50 mm**

OEM Ref.

124.550 **Ø 86,00 mm** **Piston & Ring**

124.560 **Ø 86,25 mm**

124.570 **Ø 86,50 mm**

OEM Ref. SEB22547 / SEB22548 / 42549147

124.600 **Ø 86,00 mm** **Ring**

124.610 **Ø 86,25 mm**

124.620 **Ø 86,50 mm**

OEM Ref.

305.750 **Bushing**

OEM Ref.

359.800 **Crankshaft**

OEM Ref.

359.830 **Crankshaft Flange**

OEM Ref.

ASEL CODE	360.100
OEM Reference	LP4862 / 9P924910 / 5257936 / K033378N00
Kullanılan Araç Vehicle Application	BELDE 260 CB EURO 3



Technical Data	
Cylinder Bore	Ø 86.00 mm
Swept Volume	460 cc
Stroke	40 mm

360.200 Complete Cylinder Head



OEM Ref.

360.210 Cylinder Head



OEM Ref. K047839K50

359.250 Plate



OEM Ref. K044410K50

359.300 Full Repair Kit



OEM Ref.

359.310 Repair Kit



OEM Ref.

359.320 Repair Kit

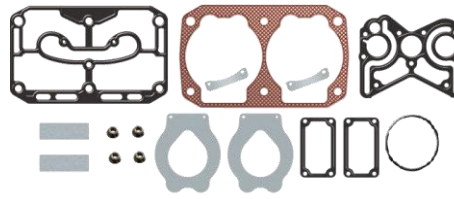

OEM Ref.

359.350 **Gasket Kit**

OEM Ref.

305.400 **Valve Kit**

OEM Ref.

360.150 **Crankcase**

OEM Ref.

305.160 **Cover**

OEM Ref.

359.165 **Cylinder Head Cover**

OEM Ref.

359.450 **Connecting Rod**

OEM Ref.

124.500 **Ø 86,00 mm** **Piston**

124.510 **Ø 86,25 mm**

124.520 **Ø 86,50 mm**

OEM Ref.

124.550 **Ø 86,00 mm** **Piston & Ring**

124.560 **Ø 86,25 mm**

124.570 **Ø 86,50 mm**

OEM Ref. SEB22547 / SEB22548 / 42549147

124.600 **Ø 86,00 mm** **Ring**

124.610 **Ø 86,25 mm**

124.620 **Ø 86,50 mm**

OEM Ref.

360.750 **Bushing**

OEM Ref.

360.800 **Crankshaft**

OEM Ref.

359.830 **Crankshaft Flange**

OEM Ref.

ASEL CODE**361.100****OEM Reference**

911 516 500 0 / 911 516 510 0 / 3976374 / 4945947 / 5272391 / CB260 / CB280

**Kullanılan Araç
Vehicle Application**

PROCITY / BELDE

**Technical Data**

Cylinder Bore	Ø 75.00 mm
Swept Volume	495 cc
Stroke	56 mm

361.200**Complete Cylinder Head**

OEM Ref. 911 516 920 2

361.210**Cylinder Head**

OEM Ref.

361.250**Plate**

OEM Ref.

361.300**Full Repair Kit**

OEM Ref.

361.320**Repair Kit**

OEM Ref.

361.330**Repair Kit**

OEM Ref.

361.350 **Gasket Kit**

OEM Ref. SEB22550

361.400 **Valve Kit**

OEM Ref.

361.150 **Crankcase**

OEM Ref.

361.160 **Cover**

OEM Ref.

361.270 **Cooling Plate**

OEM Ref.

361.450 **Connecting Rod**

OEM Ref.

501.500 **Ø 75,00 mm** **Piston**

501.510 **Ø 75,25 mm**

501.520 **Ø 75,50 mm**

OEM Ref.

501.550 **Ø 75,00 mm** **Piston & Ring**

501.560 **Ø 75,25 mm**

501.570 **Ø 75,50 mm**

OEM Ref. 411 141 623 2

109.600 **Ø 75,00 mm** **Ring**

109.610 **Ø 75,25 mm**

109.620 **Ø 75,50 mm**

OEM Ref. 3090388 / I801770061

361.800 **Crankshaft**

OEM Ref.

361.810 **Flange**

OEM Ref. 911 153 925 2

361.820 **Gear**

OEM Ref. 3942497 / 3940239

ASEL CODE	362.100
OEM Reference	LP4871 / 9P921251 / 3411777 / 5257958 / K035001N00
Kullanılan Araç Vehicle Application	PRO 1142 / PRO 1144

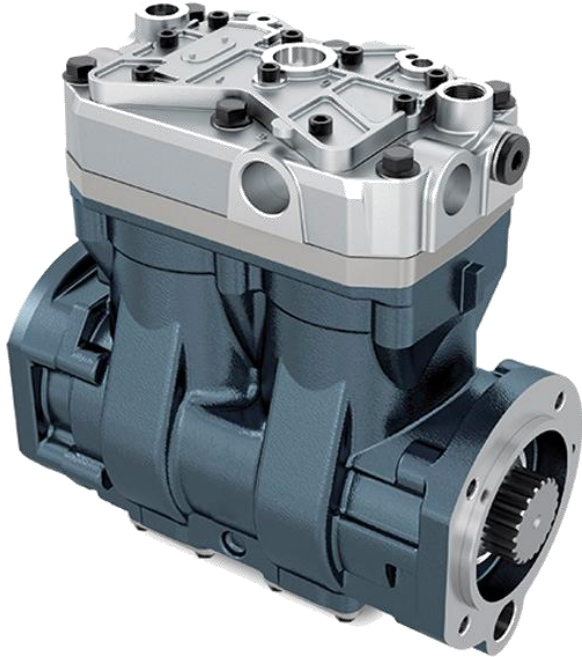

Technical Data	
Cylinder Bore	Ø 86.00 mm
Swept Volume	460 cc
Stroke	40 mm

362.200 Complete Cylinder Head

OEM Ref.

362.210 Cylinder Head

OEM Ref.

359.250 Plate

OEM Ref. K044410K50

359.300 Full Repair Kit

OEM Ref.

359.310 Repair Kit

OEM Ref.

359.320 Repair Kit

OEM Ref.

359.350

Gasket Kit

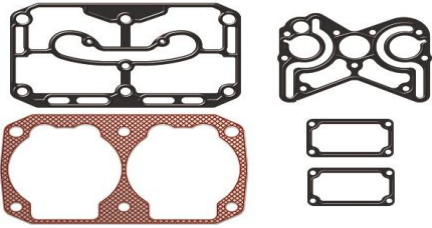

OEM Ref.

305.400

Valve Kit



OEM Ref.

362.150

Crankcase



OEM Ref.

305.160

Cover



OEM Ref.

362.165

Cylinder Head Cover



OEM Ref.

362.450

Connecting Rod



OEM Ref. SEB00967004

124.500

Ø 86,00 mm

Piston

124.510

Ø 86,25 mm

124.520

Ø 86,50 mm



OEM Ref.

124.550

Ø 86,00 mm

Piston & Ring

124.560

Ø 86,25 mm

124.570

Ø 86,50 mm



OEM Ref. SEB22547 / SEB22548 / 42549147

124.600

Ø 86,00 mm

Ring

124.610

Ø 86,25 mm

124.620

Ø 86,50 mm



OEM Ref.

362.750

Bushing



OEM Ref.

362.800

Crankshaft



OEM Ref.

362.830

Crankshaft Flange



OEM Ref.



KOMPRESOR YEDEK PARÇALARI
COMPRESSOR SPARE PARTS

İÇİNDEKİLER / INDEX

Sayfa No / Page No

VOLVO

B9R / B9L / B9S / B9TL	158-159
FH12 / FH13 / FH16 / NH12 / FM9 / FM12	160-161
FH12 / FH16 / FM12 / NH12	162-163
FH12 / FM16 / NH12 / B12	164-165
FL12 / CITY BUS / B10M / BUS B10B / B10L / B10BLE / B10LA	166-167
TURCK B10B / B10L / B10M / BUS B10B / B10BLE / B10BLA	168-169
B10M / B10L / B10B	170-171
BUS B7R / B7RLE / B10M / B10L	172-173
B10M / B10L / B10LA / B10B	174-175
FH12 / FH16 / FM7 / FM12 / NH12 / FL12 / B12 / B12B / B12R / B7L	176
FH12 / FH16 / FM12 / NH12 / FL12 / B12 / B12B / B12R	177
F10 / F12 / FL7 / FL10 / FH12 / NL10 / NL12	178-179
FL6 / FL7 / FL10 / M10	180-181
F16 / FL6 / F17 / FL10 / FL12 / NL10 / NL12	182-183
FH12 / FH13 / FH16 / FM9 / FM11 / FM13 / B13R	184-185
B12M	186-187
FH16 / FH13 / FH16 / FH16II / B13R	188
B12B	189
FH12 / FH13 / FH16 / NH12 / FM9 / FM12	190
B9L / B9TL / B9R	191
FH12 / FM12 / NH12 / FM9	192-193
FM9 / FM12 / FM16 / NH12	194-195
FM9	196-197
B6 / B7 / B10 / B12 / F16 / FL6 / FL7 / FL10 / FS7	198-199
B6 / B7R / B10B / B12 / F7 / F10 / F12 / F16 / FL7 / FL10 / FS7 / FH12 / FH16	200
FH12 / FH16 / F16	201
B7 / 3 SERIES BUS	202-203
FH16 / FM9 / FH16II	204-205
FH12 / FH16 / FM9 / FH16II / FM9 / B6 / B7 / B10	206-207
FH EURO6 / FM EURO6 / FMX EURO6	208
FH EURO6 / FM EURO6 / FMX EURO6	209
FM9 / FM12 / FH13 / FH16	210-211
FL6	212-213
F7 / F10 / F12 / F16 / FL10 / NL12 / FM10	214-215
BUS COACH / FL7 / F10 / F12 / F16 / FL10 / NL12 / FM10	216-217

ASEL CODE	401.100
OEM Reference	20775224 / 20866605 / 85000491 / 412 704 013 0 / 412 704 016 0
Kullanılan Araç Vehicle Application	B9R / B9L / B9S / B9TL



Technical Data	
Cylinder Bore	Ø 85.00 mm
Swept Volume	704 cc
Stroke	62 mm

401.200 Complete Cylinder Head



OEM Ref. 20775236
412 704 934 2 / 412 704 935 2

401.210 Cylinder Head



OEM Ref.

401.250 Plate



OEM Ref.

401.270 Cooling Plate



OEM Ref.

401.300 Full Repair Kit



OEM Ref.

401.310 Repair Kit

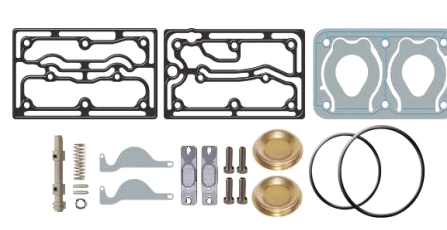

OEM Ref.

401.330 Repair Kit



OEM Ref. 412 704 939 2

401.350 Gasket Kit

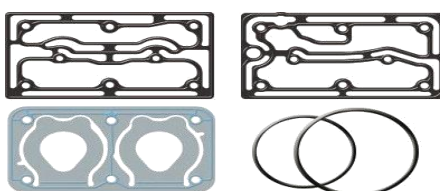

OEM Ref.

401.150 Crankcase



OEM Ref.

104.400 Valve Kit

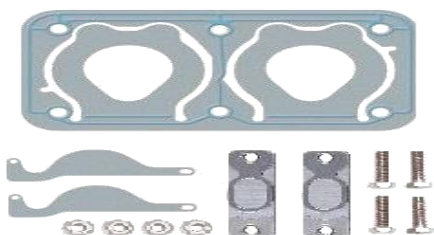

OEM Ref.

104.410 Valve Kit



OEM Ref.

401.450 Connecting Rod



OEM Ref. 1698678 / 1317201
911 505 732 2

101.500 Ø 85,00 mm Piston



OEM Ref.

101.550 Ø 85,00 mm Piston & Ring



OEM Ref. 0697442 / 1698686 / 128371
000 130 34 17 / 911 501 624 2 / 911 501 625 2

101.600 Ø 85,00 mm Ring



OEM Ref. 3094621
911 501 920 2

101.510 Ø 85,25 mm

101.560 Ø 85,25 mm

101.610 Ø 85,25 mm

101.520 Ø 85,50 mm

101.570 Ø 85,50 mm

101.620 Ø 85,50 mm

401.750 Bushing



OEM Ref.

401.800 Crankshaft



OEM Ref.

401.830 Crankshaft Flange



OEM Ref.

ASEL CODE

402.100

OEM Reference

20765890 / 20845313 / 20850846 / 412 704 012 0 / 412 704 015 0

**Kullanılan Araç
Vehicle Application**

FH12 / FH13 / FH16 / NH12 / FM9 / FM12



Technical Data

Cylinder Bore	Ø 85.00 mm
Swept Volume	704 cc
Stroke	62 mm

402.200

Complete Cylinder Head

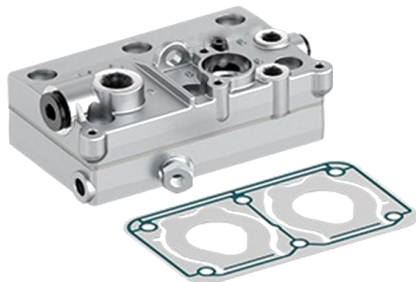

OEM Ref. 20569930 / 20775147 / 20845004
412 704 923 2 / 412 704 924 2 / 412 704 933 2

402.210

Cylinder Head



OEM Ref.

401.250

Plate



OEM Ref.

401.270

Cooling Plate



OEM Ref.

401.300

Full Repair Kit

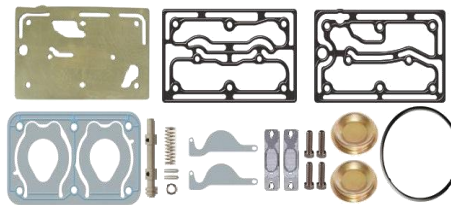

OEM Ref.

401.310

Repair Kit

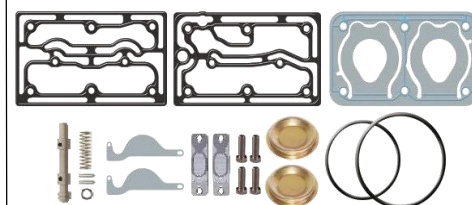

OEM Ref.

401.330

Repair Kit



OEM Ref. 412 704 939 2

401.350

Gasket Kit

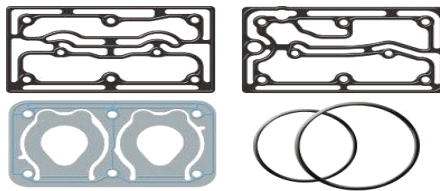

OEM Ref.

402.150

Crankcase



OEM Ref.

104.400

Valve Kit

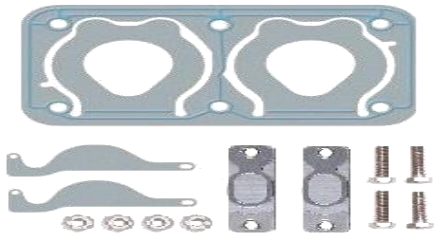

OEM Ref.

104.410

Valve Kit



OEM Ref.

401.450

Connecting Rod



OEM Ref. 1698678 / 1317201
911 505 732 2

101.500

Ø 85,00 mm

Piston

101.510

Ø 85,25 mm

101.520

Ø 85,50 mm



OEM Ref.

101.550

Ø 85,00 mm

Piston & Ring

101.560

Ø 85,25 mm

101.570

Ø 85,50 mm



OEM Ref. 0697442 / 1698686 / 128371
000 130 34 17 / 911 501 624 2 / 911 501 625 2

101.600

Ø 85,00 mm

Ring

101.610

Ø 85,25 mm

101.620

Ø 85,50 mm



OEM Ref. 3094621
911 501 920 2

401.750

Bushing



OEM Ref.

401.800

Crankshaft



OEM Ref.

401.830

Crankshaft Flange



OEM Ref.

ASEL CODE

403.100

OEM Reference

2032347 / 20547525 / 20569224 / 412 704 001 0 / 412 704 004 0 / 412 704 005 0

**Kullanılan Araç
Vehicle Application**

FH12 / FH16 / FM12 / NH12

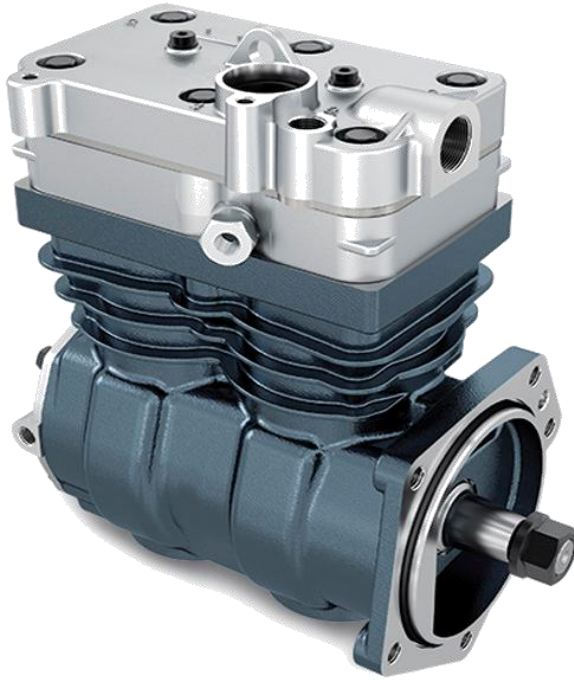

Technical Data

Cylinder Bore	Ø 85.00 mm
Swept Volume	704 cc
Stroke	62 mm

403.200

Complete Cylinder Head

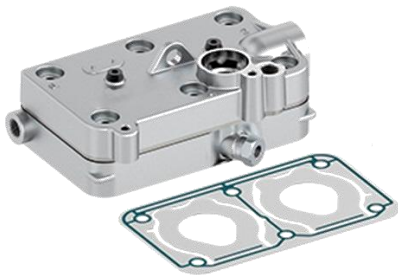

OEM Ref. 20701803 / 20701801 / 20569226
412 704 932 2 / 412 704 925 2 / 412 704 927 2

403.210

Cylinder Head



OEM Ref.

403.250

Plate



OEM Ref.

403.270

Cooling Plate



OEM Ref.

403.300

Full Repair Kit

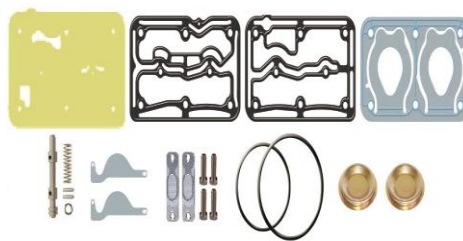

OEM Ref.

403.310

Repair Kit

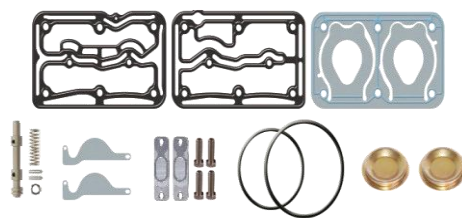

OEM Ref.

403.320 Repair Kit

OEM Ref.

403.350 Gasket Kit

OEM Ref.

403.150 Crankcase

OEM Ref.

403.340 Repair Kit

OEM Ref.

403.345 Repair Kit

OEM Ref.

403.355 Gasket Kit

OEM Ref.

101.500 Ø 85,00 mm Piston

101.510 Ø 85,25 mm

101.520 Ø 85,50 mm

OEM Ref.

101.550 Ø 85,00 mm Piston & Ring

101.560 Ø 85,25 mm

101.570 Ø 85,50 mm

OEM Ref. 0697442 / 1698686 / 128371
000 130 34 17 / 911 501 624 2 / 911 501 625 2

101.600 Ø 85,00 mm Ring

101.610 Ø 85,25 mm

101.620 Ø 85,50 mm

OEM Ref. 3094621
911 501 920 2

401.750 Bushing

OEM Ref.

403.800 Crankshaft

OEM Ref.

401.830 Crankshaft Flange

OEM Ref.

ASEL CODE

404.100

OEM Reference

LP4930 / LP4974 / 1628593 / 8113264 / 20429339 / 85000064

**Kullanılan Araç
Vehicle Application**

FH12 / FM16 / NH12 / B12

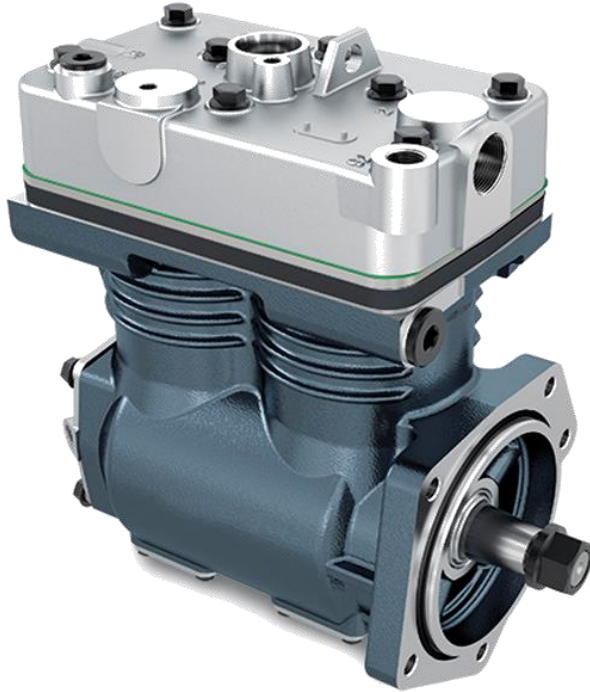

Technical Data

Cylinder Bore	Ø 88.00 mm
Swept Volume	608 cc
Stroke	50 mm

404.200

Complete Cylinder Head



OEM Ref.

404.210

Cylinder Head



OEM Ref. 169820
SEB0113804

405.250

Plate

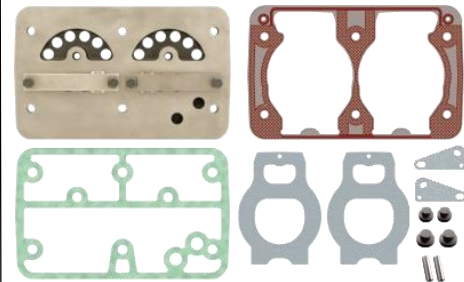

OEM Ref. 3097146
SEB01033004

405.300

Full Repair Kit

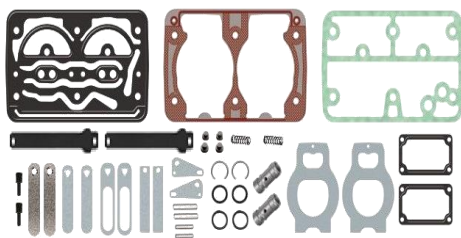

OEM Ref. 1376281 / 1376281
SEB22560

405.310

Repair Kit

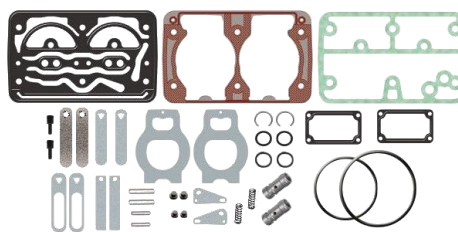

OEM Ref.

405.320

Repair Kit

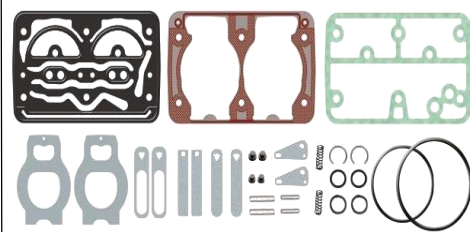

OEM Ref.

405.330 Repair Kit

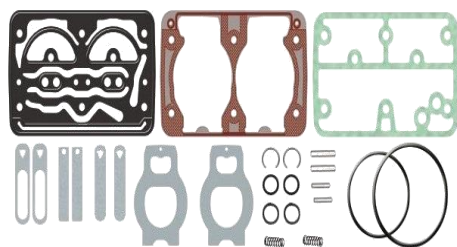

OEM Ref. SEB22461

405.350 Gasket Kit

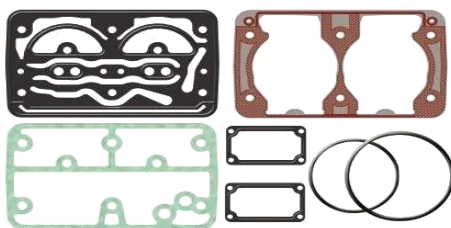

OEM Ref. 3097143
SEB22561

404.150 Crankcase



OEM Ref.

405.400 Valve Kit



OEM Ref. 3091718 / 3091739
SEB01138004 / I1326840061

405.410 Valve Kit



OEM Ref. 3097147
I159920063

405.450 Connecting Rod



OEM Ref. 3097151
SEB00967004

107.500 Ø 88,00 mm Piston



OEM Ref.

107.550 Ø 88,00 mm Piston & Ring



OEM Ref. 1698848 / 3095841 / 85101375
I81169004 / SEB22555

107.600 Ø 88,00 mm Ring



OEM Ref. I139526F0061 / I811690062

107.510 Ø 88,25 mm

107.560 Ø 88,25 mm

107.610 Ø 88,25 mm

107.520 Ø 88,50 mm

107.570 Ø 88,50 mm

107.620 Ø 88,50 mm

405.750 Bushing



OEM Ref.

404.800 Crankshaft



OEM Ref.

405.830 Crankshaft Flange



OEM Ref. 3097150
I1159920065 / SEB013090065

ASEL CODE

404.110

OEM Reference

LP4960 / 20442353 / 8112851 / 8157550 / 85000065

**Kullanılan Araç
Vehicle Application**

FL12 / CITY BUS B10M / BUS B10B / B10L / B10BLE / B10LA

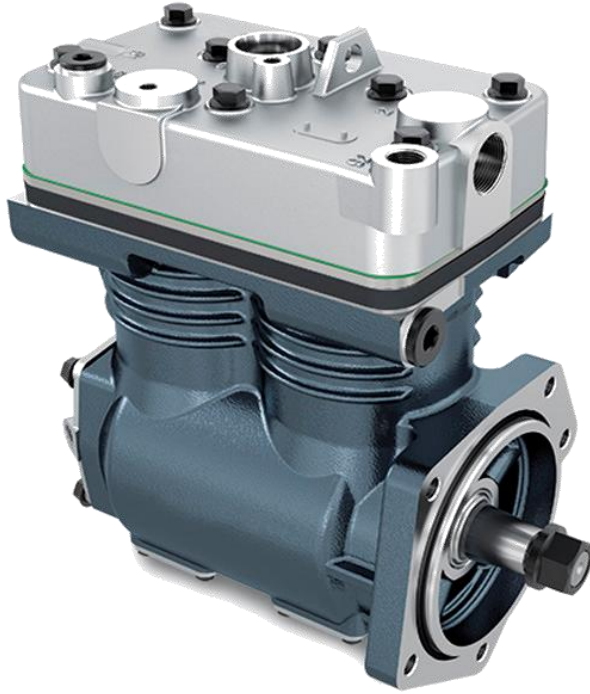

Technical Data

Cylinder Bore	Ø 88.00 mm
Swept Volume	608 cc
Stroke	50 mm

405.200

Complete Cylinder Head



OEM Ref.

405.210

Cylinder Head



OEM Ref.

405.250

Plate

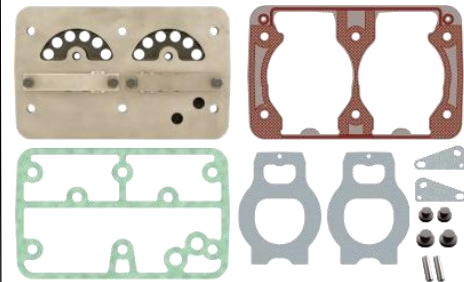

OEM Ref. 3097146
SEB01033004

405.300

Full Repair Kit

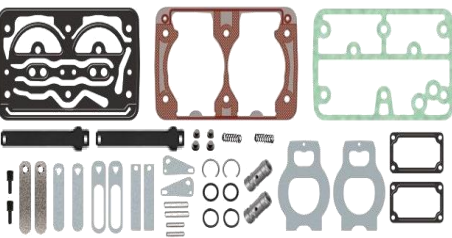

OEM Ref. 1376281 / 1376281
SEB22560

405.310

Repair Kit

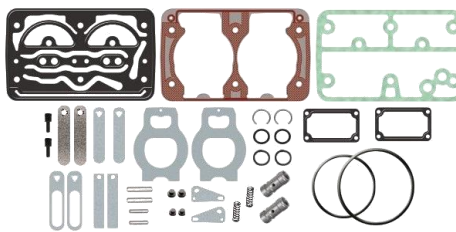

OEM Ref.

405.320

Repair Kit

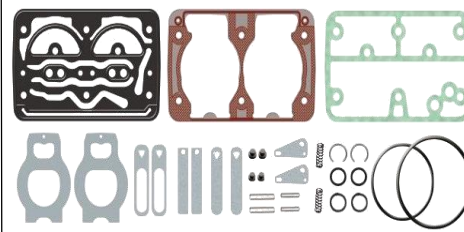

OEM Ref.

405.330 Repair Kit

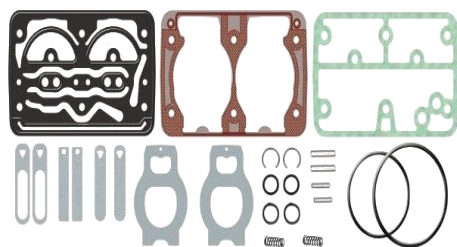

OEM Ref. SEB22461

405.350 Gasket Kit

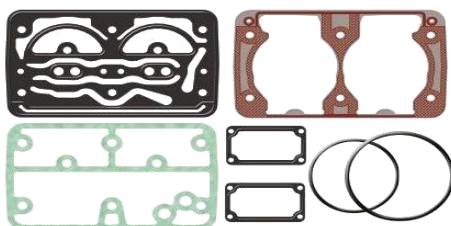

OEM Ref. 3097143
SEB22561

404.150 Crankcase



OEM Ref.

405.400 Valve Kit



OEM Ref. 3091718 / 3091739
SEB01138004 / I1326840061

405.410 Valve Kit



OEM Ref. 3097147
I159920063

404.450 Connecting Rod



OEM Ref. 3097151
SEB00967004

107.500 Ø 88,00 mm Piston



OEM Ref.

107.550 Ø 88,00 mm Piston & Ring



OEM Ref. 1698848 / 3095841 / 85101375
I81169004 / SEB22555

107.600 Ø 88,00 mm Ring



OEM Ref. I139526F0061 / I811690062

107.510 Ø 88,25 mm

107.560 Ø 88,25 mm

107.610 Ø 88,25 mm

107.520 Ø 88,50 mm

107.570 Ø 88,50 mm

107.620 Ø 88,50 mm

405.750 Bushing



OEM Ref.

404.800 Crankshaft



OEM Ref.

405.830 Crankshaft Flange



OEM Ref. 3097150
I1159920065 / SEB013090065

ASEL CODE

405.100

OEM Reference

LP4934 / II15992 / 3037346 / 8112543

**Kullanılan Araç
Vehicle Application**

TURCK B10B / B10L / B10M / BUS B10B / B10BLE / B10BLA

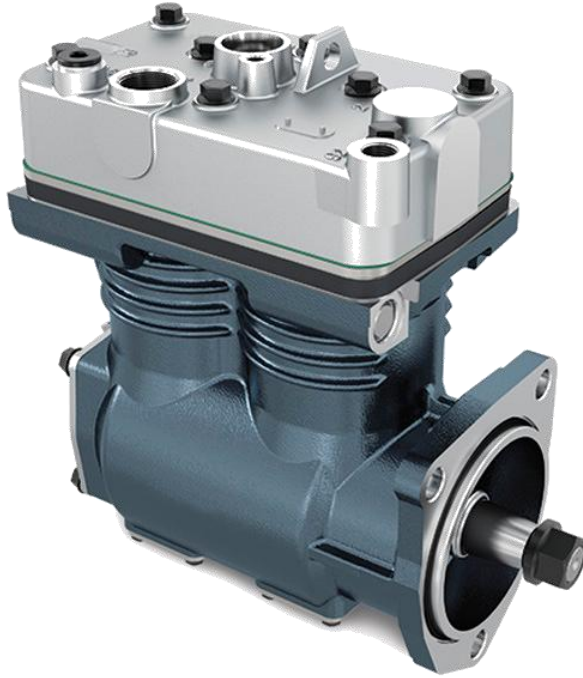

Technical Data

Cylinder Bore	Ø 88.00 mm
Swept Volume	608 cc
Stroke	50 mm

405.200

Complete Cylinder Head



OEM Ref.

405.210

Cylinder Head



OEM Ref. 3097144
SEB01052004

405.250

Plate

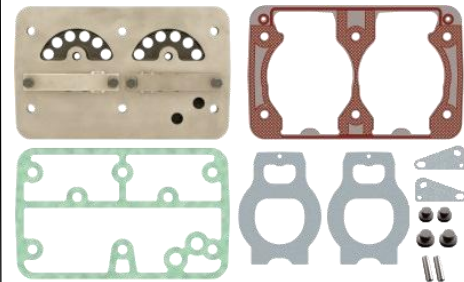

OEM Ref. 3097146
SEB01033004

405.300

Full Repair Kit

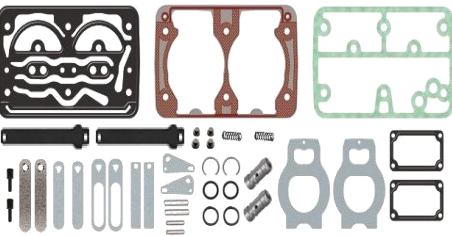

OEM Ref. 1376281 / 1376281
SEB22560

405.310

Repair Kit

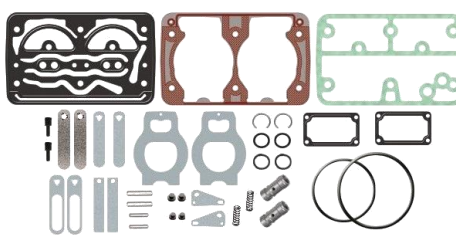

OEM Ref.

405.320

Repair Kit

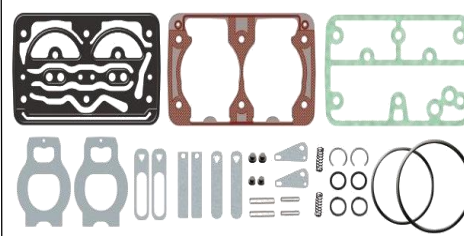

OEM Ref.

405.330 Repair Kit

405.350 Gasket Kit

405.150 Crankcase

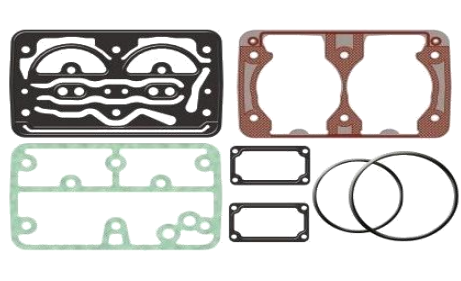
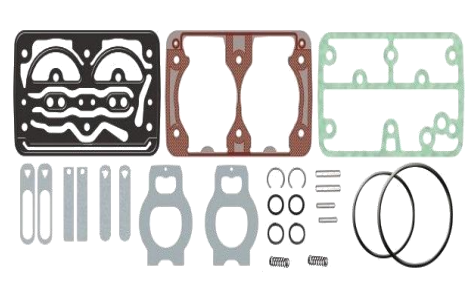

OEM Ref. SEB22461

OEM Ref.

OEM Ref.

405.400 Valve Kit

405.410 Valve Kit

405.450 Connecting Rod



OEM Ref. 3091718 / 3091739
SEB01138004 / I1326840061

OEM Ref. 3097147
I159920063

OEM Ref. 3097151
SEB00967004

107.500 Ø 88,00 mm Piston

107.550 Ø 88,00 mm Piston & Ring

107.600 Ø 88,00 mm Ring

107.510 Ø 88,25 mm

107.560 Ø 88,25 mm

107.610 Ø 88,25 mm

107.520 Ø 88,50 mm

107.570 Ø 88,50 mm

107.620 Ø 88,50 mm



OEM Ref.

OEM Ref. 1698848 / 3095841 / 85101375
I81169004 / SEB22555

OEM Ref. I139526F0061 / I811690062

405.750 Bushing

405.800 Crankshaft

405.830 Crankshaft Flange



OEM Ref.

OEM Ref.

OEM Ref. 3097150
I1159920065 / SEB013090065

ASEL CODE

405.110

OEM Reference

LP4967 / II33164000 / 8113023 / 9521675

**Kullanılan Araç
Vehicle Application**

B10M / B10L / B10B

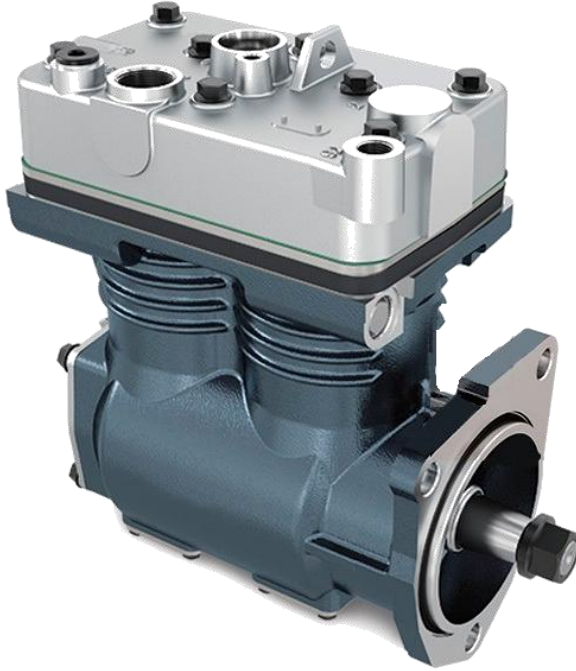

Technical Data

Cylinder Bore	Ø 88.00 mm
Swept Volume	608 cc
Stroke	50 mm

405.200

Complete Cylinder Head

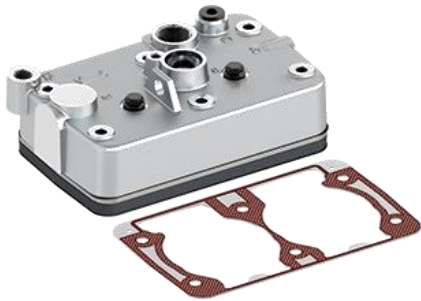

OEM Ref.

405.210

Cylinder Head



OEM Ref. 3097144
SEB01052004

405.250

Plate

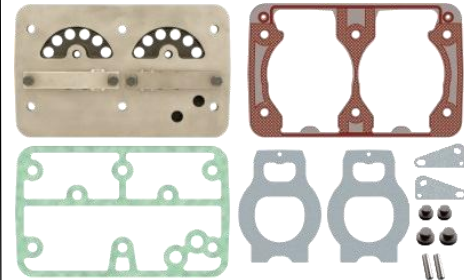

OEM Ref. 3097146
SEB01033004

405.300

Full Repair Kit

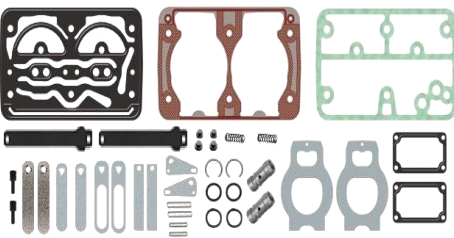

OEM Ref. 1376281 / 1376281
SEB22560

405.310

Repair Kit

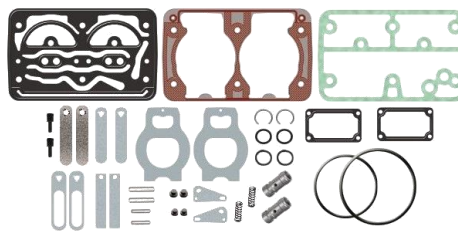

OEM Ref.

405.320

Repair Kit

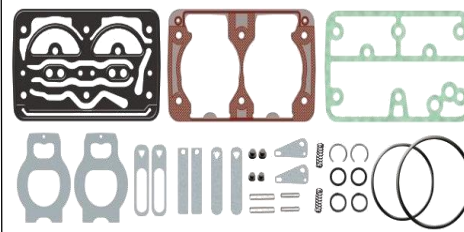

OEM Ref.

405.330 Repair Kit

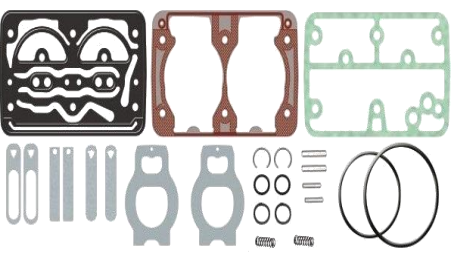

OEM Ref. SEB22461

405.350 Gasket Kit

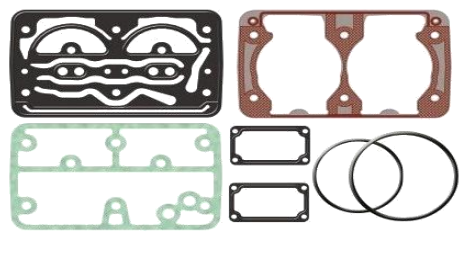

OEM Ref.

405.155 Crankcase



OEM Ref.

405.400 Valve Kit



OEM Ref. 3091718 / 3091739
SEB01138004 / I1326840061

405.410 Valve Kit



OEM Ref. 3097147
I159920063

405.450 Connecting Rod



OEM Ref. 3097151
SEB00967004

107.500 Ø 88,00 mm Piston

107.510 Ø 88,25 mm

107.520 Ø 88,50 mm



OEM Ref.

107.550 Ø 88,00 mm Piston & Ring

107.560 Ø 88,25 mm

107.570 Ø 88,50 mm



OEM Ref. 1698848 / 3095841 / 85101375
I81169004 / SEB22555

107.600 Ø 88,00 mm Ring

107.610 Ø 88,25 mm

107.620 Ø 88,50 mm



OEM Ref. I139526F0061 / I811690062

405.750 Bushing



OEM Ref.

405.800 Crankshaft



OEM Ref.

405.830 Crankshaft Flange



OEM Ref. 3097150
I1159920065 / SEB013090065

ASEL CODE

406.100

OEM Reference

LK4921/LP4989/LP4989/3194908/8113634/8113484/ 70305892/70330094/703303446

**Kullanılan Araç
Vehicle Application**

CITY BUS / BUS B7R / B7RLE / B10M / B10R

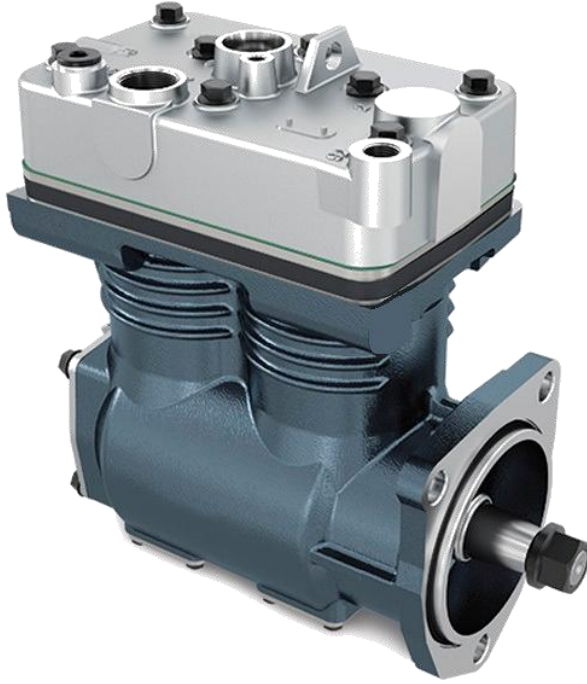

Technical Data

Cylinder Bore	Ø 88.00 mm
Swept Volume	608 cc
Stroke	50 mm

406.200

Complete Cylinder Head



OEM Ref.

406.210

Cylinder Head



OEM Ref.3095839
SEB01551004

406.250

Plate

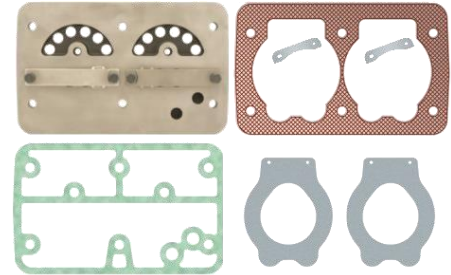

OEM Ref. 3095845
SEB01034004

406.300

Full Repair Kit

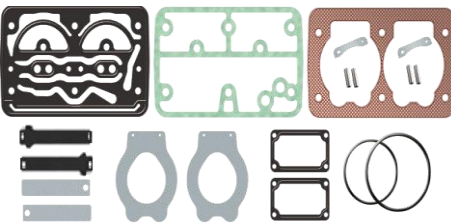

OEM Ref.

406.310

Repair Kit

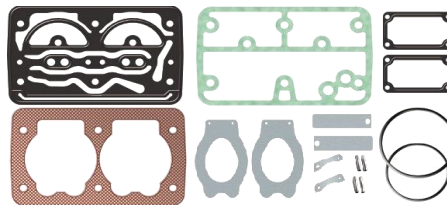

OEM Ref.

406.320

Repair Kit

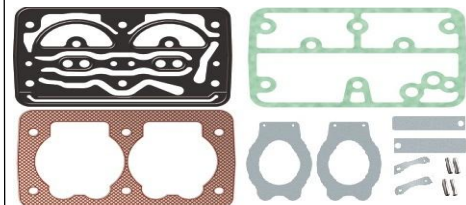

OEM Ref.

406.350 Gasket Kit

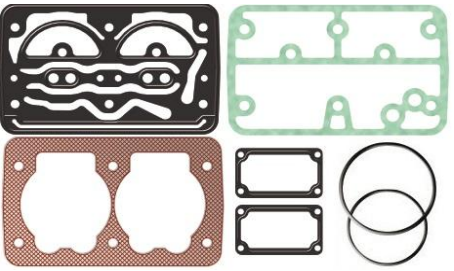

OEM Ref.

406.150 Crankcase



OEM Ref.

405.160 Cover



OEM Ref.

406.400 Valve Kit

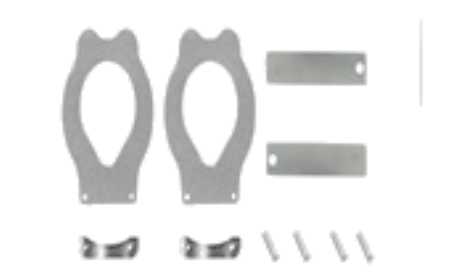

OEM Ref.

405.450 Connecting Rod



OEM Ref. 3097151
SEB00967004

406.820 Gear



OEM Ref. 478777 / 470775

107.500 Ø 88,00 mm Piston

107.510 Ø 88,25 mm

107.520 Ø 88,50 mm



OEM Ref.

107.550 Ø 88,00 mm Piston & Ring

107.560 Ø 88,25 mm

107.570 Ø 88,50 mm



OEM Ref. 1698848 / 3095841 / 85101375
I81169004 / SEB22555

107.600 Ø 88,00 mm Ring

107.610 Ø 88,25 mm

107.620 Ø 88,50 mm



OEM Ref. I139526F0061 / I811690062

405.750 Bushing



OEM Ref.

405.800 Crankshaft



OEM Ref.

405.830 Crankshaft Flange



OEM Ref. 3097150
I1159920065 / SEB013090065

ASEL CODE

406.110

OEM Reference

LK4918 / LP4986 / LP4993 / 3193734 / 8113633 / 70305889 / 70330081 / 85000194

**Kullanılan Araç
Vehicle Application**

B10M / B10L / B10LA / B10B

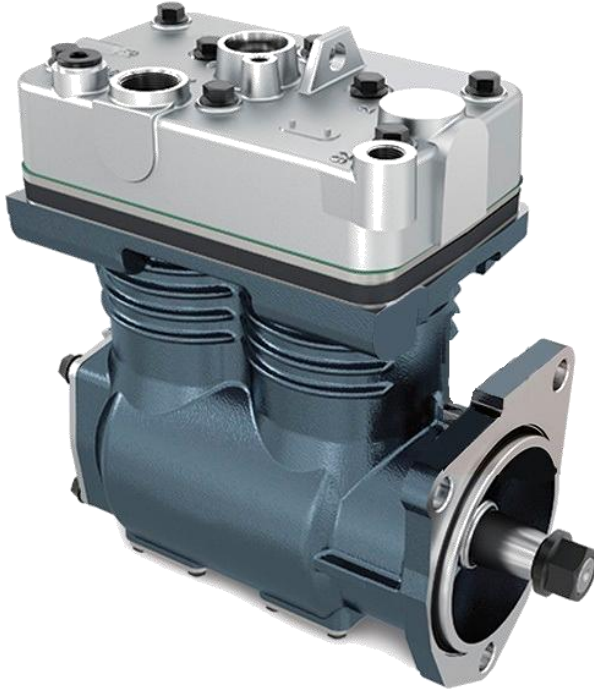

Technical Data

Cylinder Bore	Ø 88.00 mm
Swept Volume	608 cc
Stroke	50 mm

406.200

Complete Cylinder Head

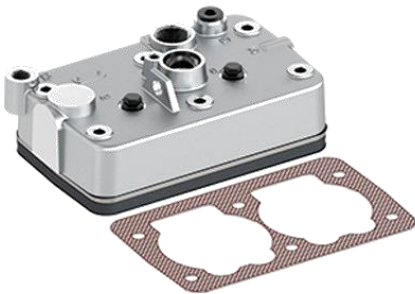

OEM Ref.

406.210

Cylinder Head



OEM Ref.3095839
SEB01551004

406.250

Plate

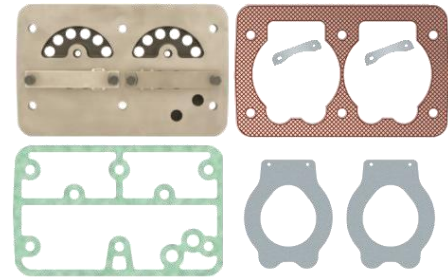

OEM Ref. 3095845
SEB01034004

406.300

Full Repair Kit

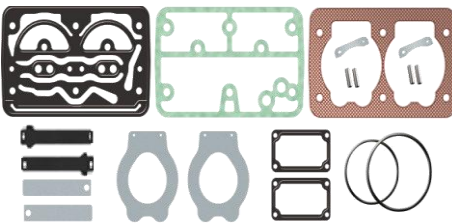

OEM Ref.

406.310

Repair Kit

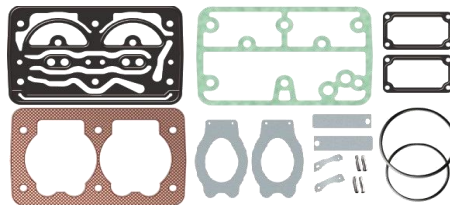

OEM Ref.

406.320

Repair Kit

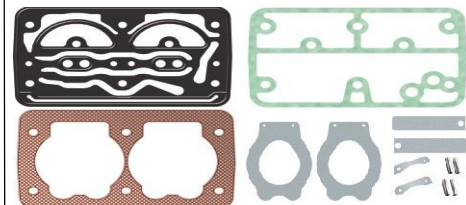

OEM Ref.

406.350 **Gasket Kit**

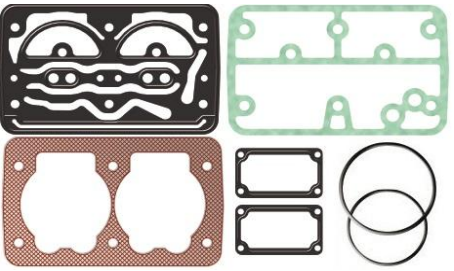

OEM Ref.

406.155 **Crankcase**



OEM Ref.

405.160 **Cover**



OEM Ref.

406.400 **Valve Kit**

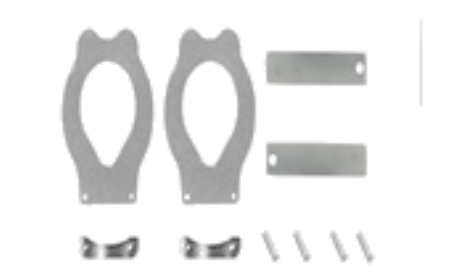

OEM Ref.

405.450 **Connecting Rod**



OEM Ref. 3097151
SEB00967004

119.170 **Nut**



OEM Ref. 1698672 / 0698060 / 11712509
004 990 32 51 / 810 341 001 4

107.500 **Ø 88,00 mm** **Piston**

107.510 **Ø 88,25 mm**

107.520 **Ø 88,50 mm**



OEM Ref.

107.550 **Ø 88,00 mm** **Piston & Ring**

107.560 **Ø 88,25 mm**

107.570 **Ø 88,50 mm**



OEM Ref. 1698848 / 3095841 / 85101375
I81169004 / SEB22555

107.600 **Ø 88,00 mm** **Ring**

107.610 **Ø 88,25 mm**

107.620 **Ø 88,50 mm**



OEM Ref. I139526F0061 / I811690062

405.750 **Bushing**



OEM Ref.

405.800 **Crankshaft**



OEM Ref.

405.830 **Crankshaft Flange**



OEM Ref. 3097150
I1159920065 / SEB013090065

ASEL CODE

406.120

OEM Reference

LP4985 / 3173001 / 8113405 / 20429343 / 85000066

**Kullanılan Araç
Vehicle Application**

FH12 / FH16 / FM7 / FM12 / NH12 / FL12 / B12 / B12B / B12R / B7L

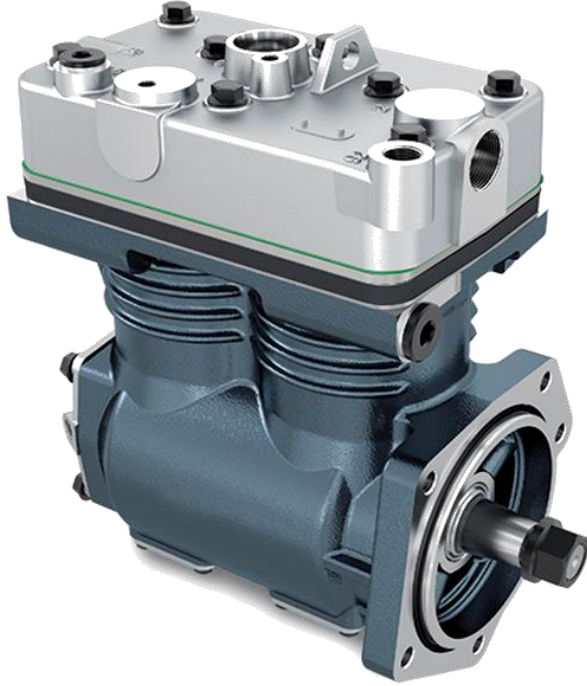

Technical Data

Cylinder Bore	Ø 88.00 mm
Swept Volume	608 cc
Stroke	50 mm

406.205

Complete Cylinder Head

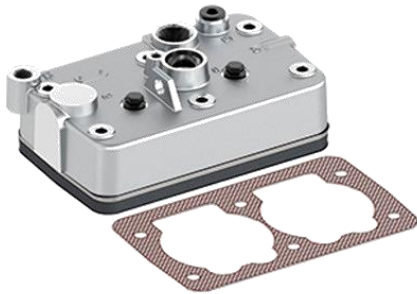

OEM Ref. K040594K50

406.215

Cylinder Head



OEM Ref.

406.250

Plate

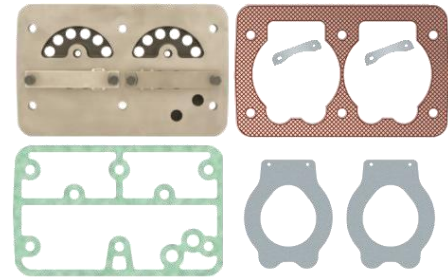

OEM Ref. 3095845
SEB01034004

406.300

Full Repair Kit

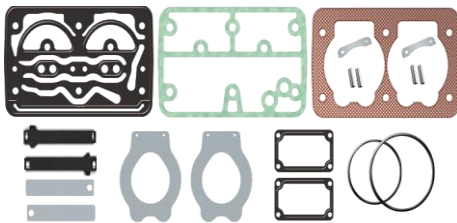

OEM Ref.

406.140

Crankcase



OEM Ref.

107.550

Ø 88,00 mm Piston & Ring

107.560

Ø 88,25 mm

107.570

Ø 88,50 mm



OEM Ref. 1698848 / 3095841 / 85101375
I81169004 / SEB22555

ASEL CODE

406.130

OEM Reference

LP4991 / LP4992 / 70330098 / 85000199 / K002031000

**Kullanılan Araç
Vehicle Application**

FH12 / FH16 / FM12 / NH12 / FL12 / B12 / B12B / B12R

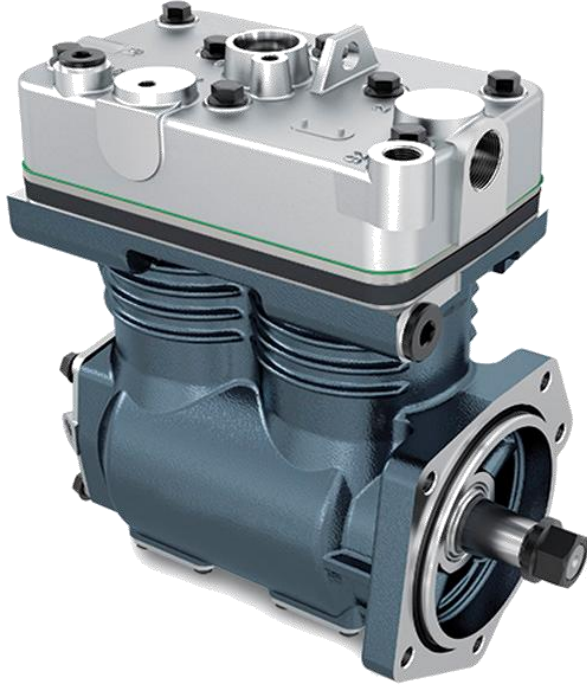

Technical Data

Cylinder Bore	Ø 88.00 mm
Swept Volume	608 cc
Stroke	50 mm

406.205

Complete Cylinder Head

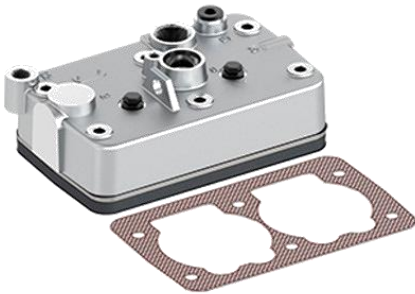

OEM Ref. K040594K50

406.215

Cylinder Head



OEM Ref.

406.250

Plate

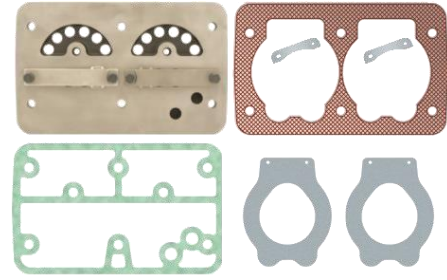

OEM Ref. 3095845
SEB01034004

406.300

Full Repair Kit

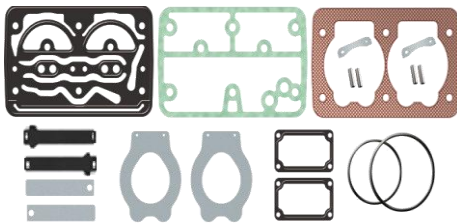

OEM Ref.

406.140

Crankcase



OEM Ref.

406.825

Gear



OEM Ref. 1549425

ASEL CODE

407.100

OEM Reference

KZ433 – 1RM / 1080437 / 1186722 / 1590264 / 1612335 / 5001608 / 8112780

**Kullanılan Araç
Vehicle Application**

F10 / F12 / FL7 / FL10 / FH12 / NL10 / NL12

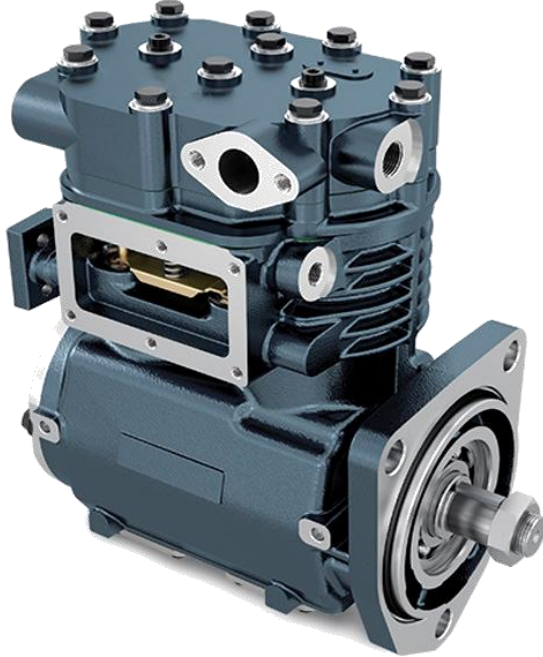

Technical Data

Cylinder Bore	Ø 75.00 mm
Swept Volume	440 cc
Stroke	50 mm

407.200

Complete Cylinder Head

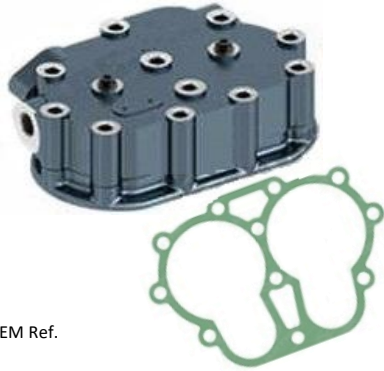

OEM Ref.

407.210

Cylinder Head

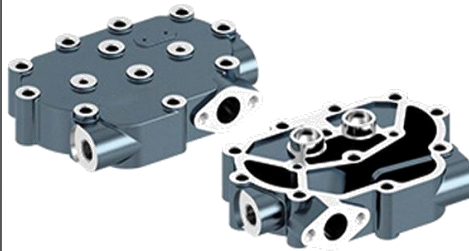

OEM Ref.

407.250

Plate



OEM Ref.

407.300

Full Repair Kit

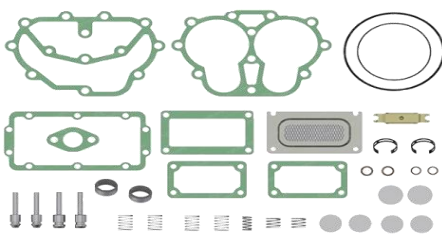

OEM Ref.

407.310

Repair Kit

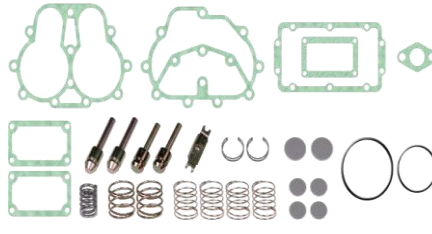

OEM Ref.

407.320

Repair Kit

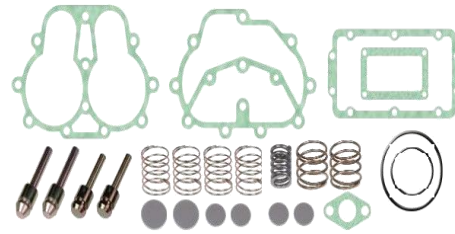

OEM Ref.

407.350 **Gasket Kit**

OEM Ref.

407.150 **Crankcase**

OEM Ref.

407.160 **Cover**

OEM Ref.

407.165 **Cover**

OEM Ref.

407.400 **Valve Kit**

OEM Ref.

407.450 **Connecting Rod**

OEM Ref. 3090257

407.500 **Ø 75,00 mm** **Piston**

407.510 **Ø 75,25 mm**

407.520 **Ø 75,50 mm**

OEM Ref. 1697706
1189256

407.550 **Ø 75,00 mm** **Piston & Ring**

407.560 **Ø 75,25 mm**

407.570 **Ø 75,50 mm**

OEM Ref. 1518358 / 3094151
1189082

407.600 **Ø 75,00 mm** **Ring**

407.610 **Ø 75,25 mm**

407.620 **Ø 75,50 mm**

OEM Ref. 3090257 / 3094155

407.800 **Crankcase**

OEM Ref.

407.830 **Crankshaft Flange**

OEM Ref. 3090239

407.820 **Gear**

OEM Ref. 423087

ASEL CODE

408.100

OEM Reference

LP4850 / II35564000 / 8113270 / 8119270 / 8129779

**Kullanılan Araç
Vehicle Application**

FL6 / FL7 / FL10 / M10

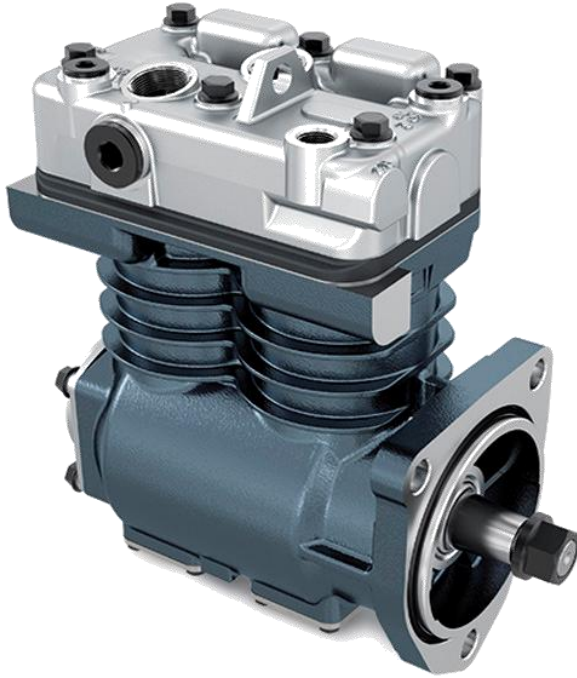

Technical Data

Cylinder Bore	Ø 75.00 mm
Swept Volume	440 cc
Stroke	50 mm

408.200

Complete Cylinder Head



OEM Ref.

408.210

Cylinder Head



OEM Ref. 8127749
SEB0515004

408.250

Plate

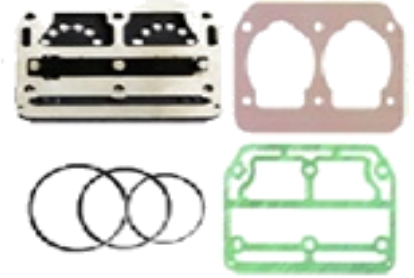

OEM Ref. 8127751
SEB01000004

408.300

Full Repair Kit

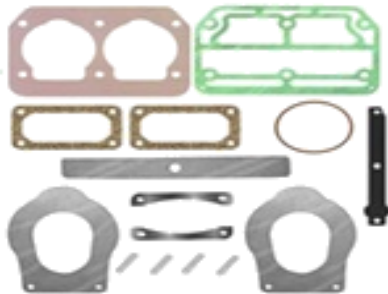

OEM Ref.

408.310

Repair Kit

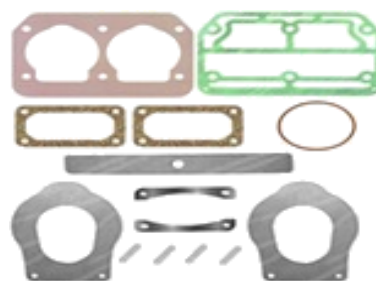

OEM Ref. 1285856
SEB22543

408.320

Repair Kit

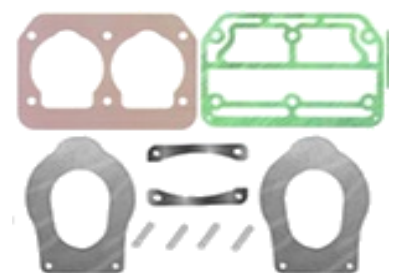

OEM Ref.

408.350 **Gasket Kit**

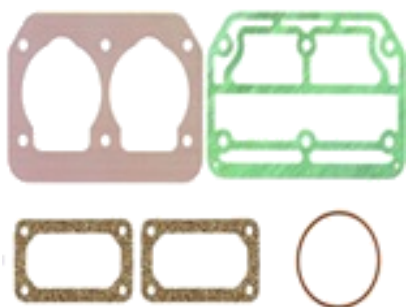

OEM Ref.

408.150 **Crankcase**



OEM Ref.

405.160 **Cover**



OEM Ref.

407.400 **Valve Kit**

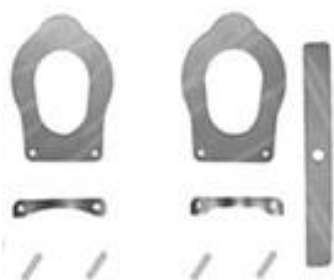

OEM Ref. II326840061

408.450 **Connecting Rod**



OEM Ref. 1697281 / 1698528 / 3090386
SEB00626004 / SEB00957004

119.170 **Nut**



OEM Ref. 1698672 / 0698060 / 11712509
004 990 32 51 / 810 341 001 4

109.500 **Ø 75,00 mm** **Piston**

109.510 **Ø 75,25 mm**

109.520 **Ø 75,50 mm**



OEM Ref.

109.550 **Ø 75,00 mm** **Piston & Ring**

109.560 **Ø 75,25 mm**

109.570 **Ø 75,50 mm**



OEM Ref. SEB22539 / SEB22540

109.600 **Ø 75,00 mm** **Ring**

109.610 **Ø 75,25 mm**

109.620 **Ø 75,50 mm**



OEM Ref. 3090388 / I801770061

408.800 **Crankshaft**



OEM Ref. 1697285
EB007622V

408.830 **Crankshaft Flange**



OEM Ref. 3090385 / 1697769
SEB00387004

406.820 **Gear**



OEM Ref. 478777 / 470775

ASEL CODE

409.100

OEM Reference

LP4825 / II15993000 / 8112427 / 8150407 / 81124273

**Kullanılan Araç
Vehicle Application**

F16 / FL6 / F17 / FL10 / FL12 / NL10 / NL12

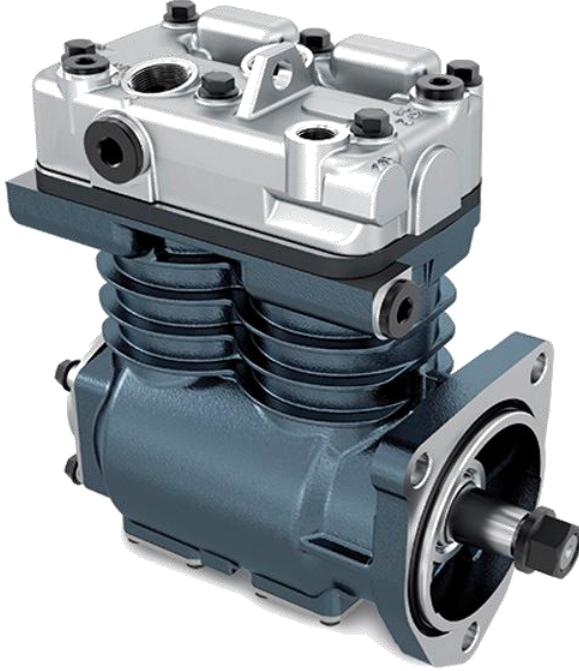

Technical Data

Cylinder Bore	Ø 75.00 mm
Swept Volume	440 cc
Stroke	50 mm

409.200

Complete Cylinder Head

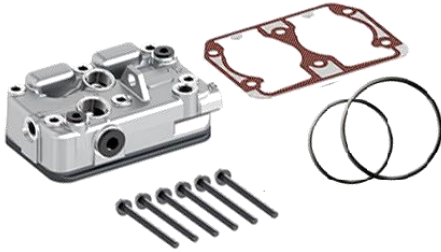

OEM Ref. SEB010800061

409.210

Cylinder Head



OEM Ref. SEB01080004 / 3090378

409.250

Plate

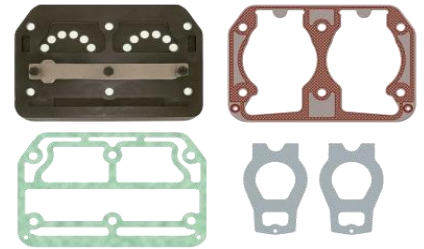

OEM Ref. SEB01081004 / 3090380

409.300

Full Repair Kit



OEM Ref.

409.310

Repair Kit



OEM Ref. SEB22545

409.320

Repair Kit

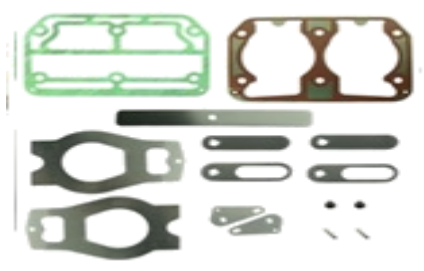

OEM Ref.

409.350 Gasket Kit

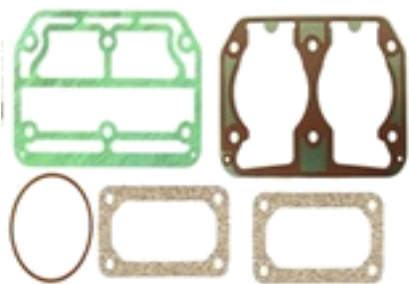

OEM Ref.

409.150 Crankcase



OEM Ref.

405.160 Cover



OEM Ref.

409.400 Valve Kit



OEM Ref. II326840061

405.410 Valve Kit



OEM Ref. 3097147
II59920063

408.450 Connecting Rod



OEM Ref. 1697281 / 1698528 / 3090386
SEB00626004 / SEB00957004

109.500 Ø 75,00 mm Piston

109.510 Ø 75,25 mm

109.520 Ø 75,50 mm



OEM Ref.

109.550 Ø 75,00 mm Piston & Ring

109.560 Ø 75,25 mm

109.570 Ø 75,50 mm



OEM Ref. SEB22539 / SEB22540

109.600 Ø 75,00 mm Ring

109.610 Ø 75,25 mm

109.620 Ø 75,50 mm



OEM Ref. 3090388 / I801770061

408.800 Crankshaft



OEM Ref. 1697285
EB007622V

408.830 Crankshaft Flange



OEM Ref. 3090385 / 1697769
SEB00387004

406.820 Gear



OEM Ref. 478777 / 470775

ASEL CODE

410.100

OEM Reference

20774294 / 912 512 008 0

**Kullanılan Araç
Vehicle Application**

FH12 / FH13 / FH16 / FM9 / FM11 / FM13 / B13R

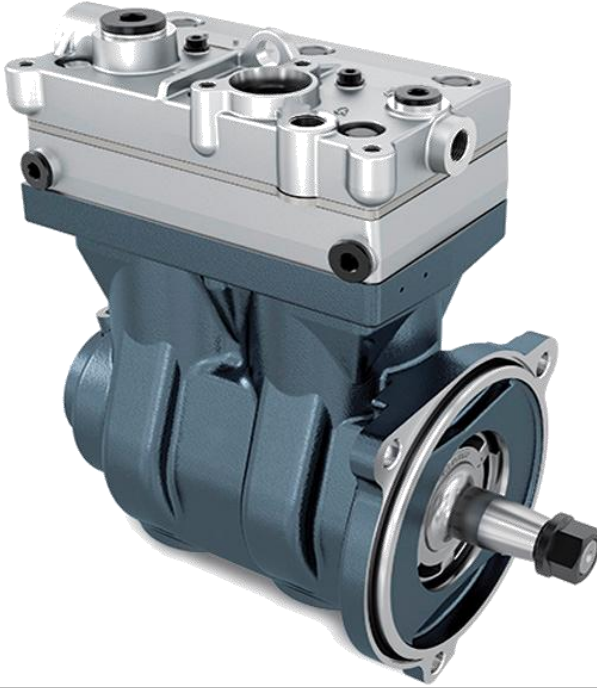

Technical Data

Cylinder Bore	Ø 85.00 mm
Swept Volume	636 cc
Stroke	56 mm

410.200

Complete Cylinder Head

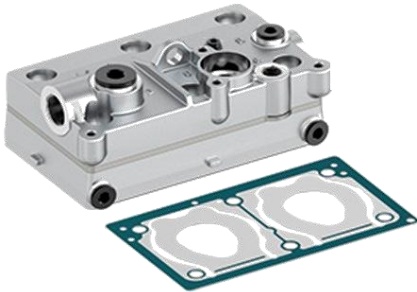

OEM Ref.

410.210

Cylinder Head



OEM Ref.

410.250

Plate

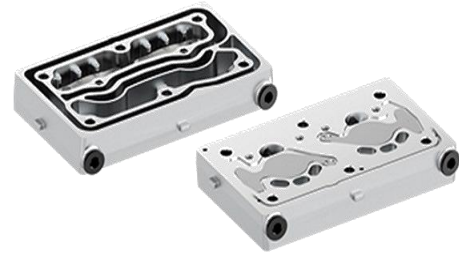

OEM Ref.

410.300

Full Repair Kit

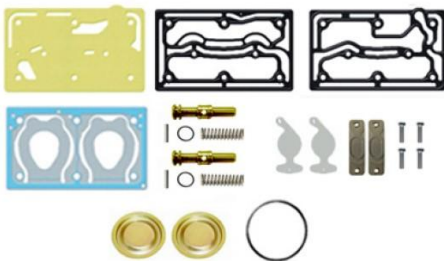

OEM Ref.

410.310

Repair Kit

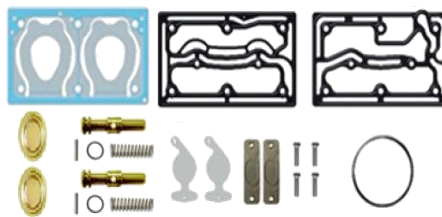

OEM Ref.

410.320

Repair Kit

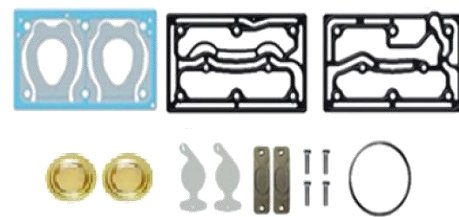

OEM Ref.

410.350 **Gasket Kit**

OEM Ref.

410.270 **Cooling Plate**

OEM Ref.

410.150 **Crankcase**

OEM Ref.

102.400 **Valve Kit**

OEM Ref.

102.410 **Valve Kit**

OEM Ref.

118.450 **Connecting Rod**

OEM Ref. 3357219 / 2VF145041
000 131 24 17 / 911 145 737 2

101.500 **Ø 85,00 mm** **Piston**

101.510 **Ø 85,25 mm**

101.520 **Ø 85,50 mm**

OEM Ref.

101.550 **Ø 85,00 mm** **Piston & Ring**

101.560 **Ø 85,25 mm**

101.570 **Ø 85,50 mm**

OEM Ref. 0697442 / 1698686 / 1283781 / FBU2076
000 130 34 17 / 911 501 624 2 / 911 501 625 2

101.600 **Ø 85,00 mm** **Ring**

101.610 **Ø 85,25 mm**

101.620 **Ø 85,50 mm**

OEM Ref. 3094621
911 501 920 2

410.760 **Adapter**

OEM Ref. 912 003 340 4 / 912 003 340 6

410.800 **Crankshaft**

OEM Ref. 3090385 / 1697769
SEB00387004

410.820 **Gear**

OEM Ref. 3161258

ASEL CODE

411.100

OEM Reference

20824559 / 912 512 007 0

**Kullanılan Araç
Vehicle Application**

B12M

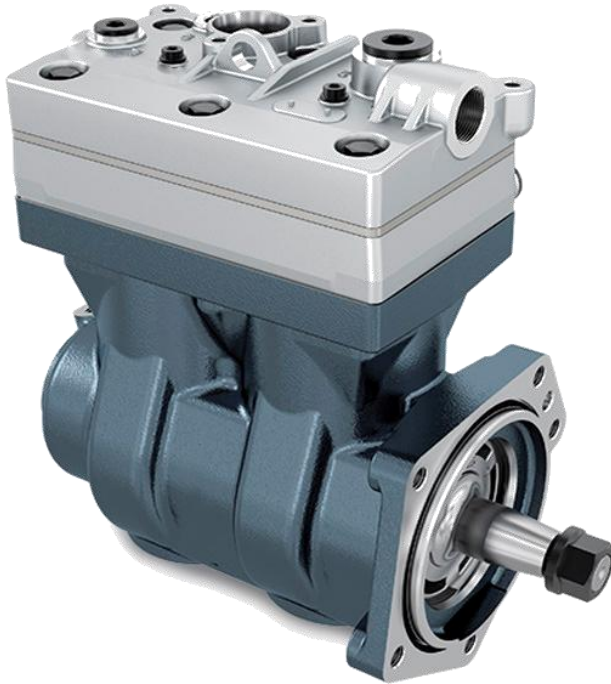

Technical Data

Cylinder Bore	Ø 85.00 mm
Swept Volume	636 cc
Stroke	56 mm

411.200

Complete Cylinder Head

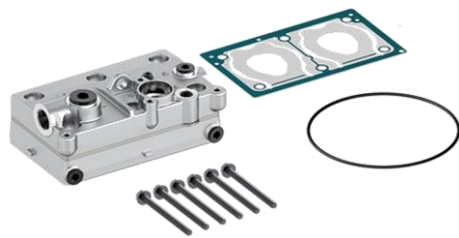

OEM Ref. 412 740 940 2 / 912 512 924 2 / 412 512 925 2
20774299 / 20889546 / 21418150 / 21707608

411.210

Cylinder Head



OEM Ref.

410.250

Plate



OEM Ref.

411.300

Full Repair Kit

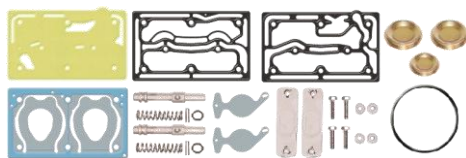

OEM Ref. 742 132 231 8
912 512 927

411.310

Repair Kit

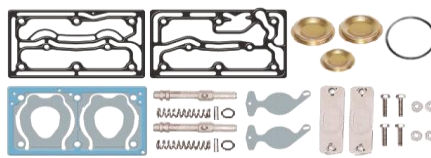

OEM Ref. 742 077 429 2 / 742 131 807 5
21322318

411.320

Repair Kit

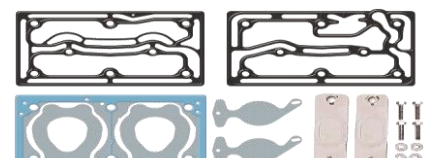

OEM Ref. 412 704 928 2

411.350 **Gasket Kit**

OEM Ref.

410.270 **Cooling Plate**

OEM Ref.

411.150 **Crankcase**

OEM Ref.

102.400 **Valve Kit**

OEM Ref.

102.410 **Valve Kit**

OEM Ref.

118.450 **Connecting Rod**

OEM Ref. 3357219 / 2VF145041
000 131 24 17 / 911 145 737 2

101.500 **Ø 85,00 mm** **Piston**

101.510 **Ø 85,25 mm**

101.520 **Ø 85,50 mm**

OEM Ref.

101.550 **Ø 85,00 mm** **Piston & Ring**

101.560 **Ø 85,25 mm**

101.570 **Ø 85,50 mm**

OEM Ref. 0697442 / 1698686 / 1283781 / FBU2076
000 130 34 17 / 911 501 624 2 / 911 501 625 2

101.600 **Ø 85,00 mm** **Ring**

101.610 **Ø 85,25 mm**

101.620 **Ø 85,50 mm**

OEM Ref. 3094621
911 501 920 2

410.760 **Adapter**

OEM Ref. 912 003 340 4 / 912 003 340 6

411.800 **Crankshaft**

OEM Ref.

411.820 **Gear**

OEM Ref. 1549425

ASEL CODE

411.110

OEM Reference

20774294 / 912 512 004 0

**Kullanılan Araç
Vehicle Application**

FH12 / FH 13 / FH16 / FH16II / B13R



Technical Data

Cylinder Bore	Ø 85.00 mm
Swept Volume	636 cc
Stroke	56 mm

411.200

Complete Cylinder Head

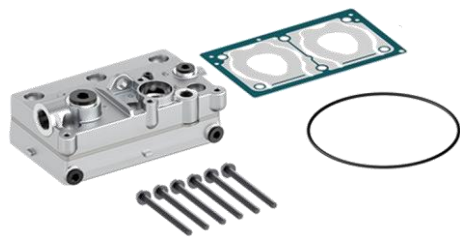

OEM Ref. 412 740 940 2 / 912 512 924 2 / 412 512 925 2
20774299 / 20889546 / 21418150 / 21707608

411.210

Cylinder Head



OEM Ref.

410.250

Plate



OEM Ref.

411.300

Full Repair Kit

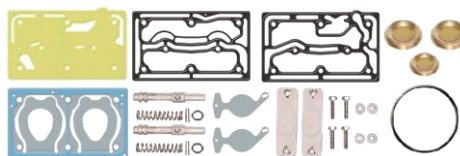

OEM Ref. 742 132 231 8
912 512 927

410.150

Crankcase



OEM Ref.

410.800

Crankshaft



OEM Ref.

ASEL CODE

411.120

OEM Reference

20770303 / 850000648 / 912 512 006 0

**Kullanılan Araç
Vehicle Application**

B12B

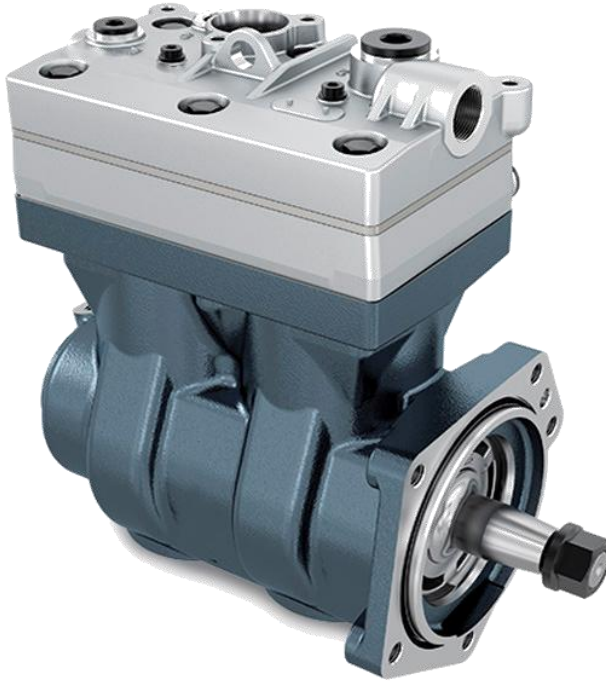

Technical Data

Cylinder Bore	Ø 85.00 mm
Swept Volume	636 cc
Stroke	56 mm

411.200

Complete Cylinder Head

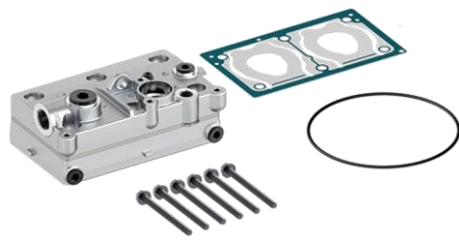

OEM Ref. 412 740 940 2 / 912 512 924 2 / 412 512 925 2
20774299 / 20889546 / 21418150 / 21707608

411.210

Cylinder Head



OEM Ref.

410.250

Plate



OEM Ref.

411.300

Full Repair Kit

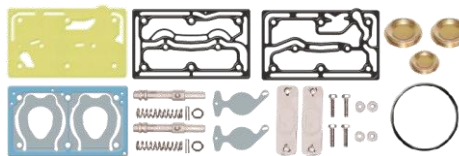

OEM Ref. 742 132 231 8
912 512 927

411.150

Crankcase



OEM Ref.

411.800

Crankshaft



OEM Ref.

ASEL CODE**411.130****OEM Reference**

20765890 / 20845313 / 21172036 / 21379906 / 85000615 / 412704 018 0 / 412 704 018 7

**Kullanılan Araç
Vehicle Application**

FH12 / FH13 / FH16 / NH12 / FM9 / FM12

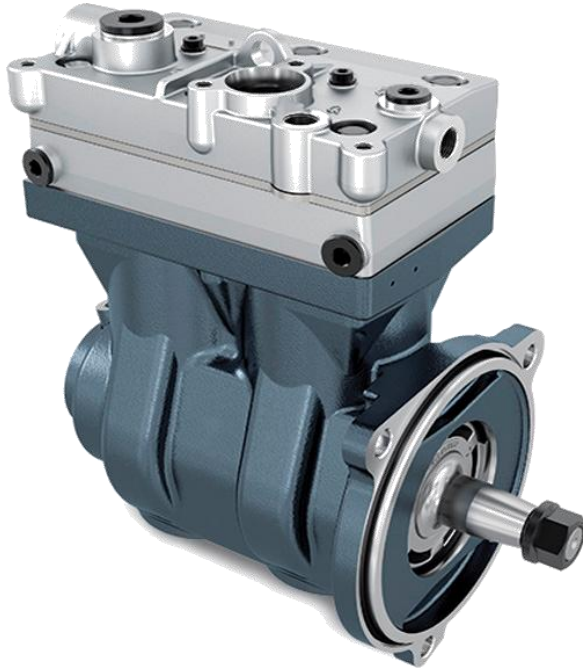
**Technical Data**

Cylinder Bore	Ø 85.00 mm
Swept Volume	704 cc
Stroke	62 mm

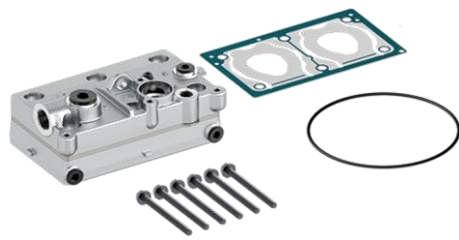
411.200**Complete Cylinder Head**OEM Ref. 412 740 940 2 / 912 512 924 2 / 412 512 925 2
20774299 / 20889546 / 21418150 / 21707608**411.210****Cylinder Head**

OEM Ref.

410.250**Plate**

OEM Ref.

411.155**Crankcase**OEM Ref. 742 132 231 8
912 512 927**411.450****Connecting Rod**

OEM Ref.

411.805**Crankshaft**

OEM Ref.

ASEL CODE	412.100
OEM Reference	21521355 / 21968013 / 912 512 017 0
Kullanılan Araç Vehicle Application	B9L / B9TL / B9R



Technical Data	
Cylinder Bore	∅ 85.00 mm
Swept Volume	636 cc
Stroke	56 mm

412.200 Complete Cylinder Head



OEM Ref. 912 512 931 2
21316442

411.210 Cylinder Head



OEM Ref.

412.250 Plate



OEM Ref.

412.300 Full Repair Kit

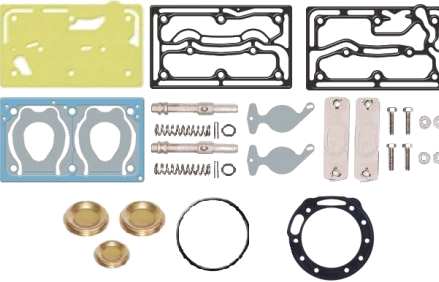

OEM Ref.

412.310 Repair Kit

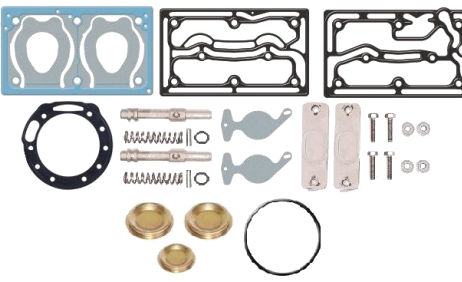

OEM Ref.

412.350 Gasket Kit



OEM Ref.

ASEL CODE

413.100

OEM Reference

20382348 / 21353460 / 85000118 / 85013203 / 412 352 005 0 / 412 352 030 0

**Kullanılan Araç
Vehicle Application**

FH12 / FM12 / NH12 / FM9

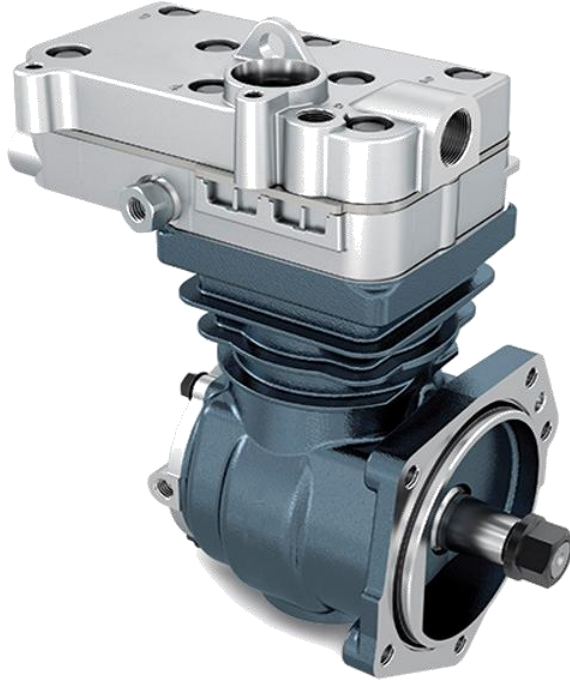

Technical Data

Cylinder Bore	Ø 85.00 mm
Swept Volume	352 cc
Stroke	62 mm

413.200

Complete Cylinder Head

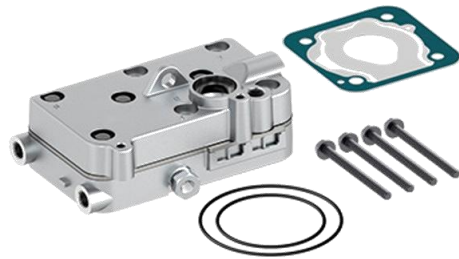

OEM Ref. 85104246 / 412 352 921 2

413.210

Cylinder Head



OEM Ref.

413.250

Plate

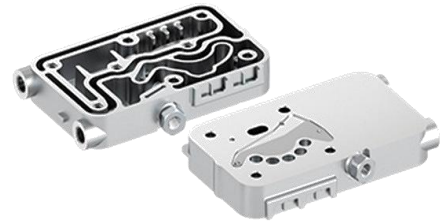

OEM Ref.

413.300

Full Repair Kit

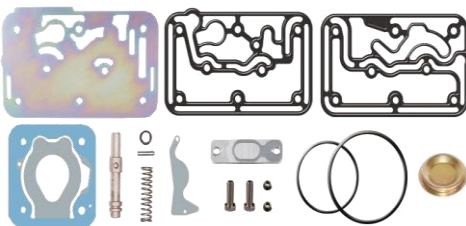

OEM Ref.

413.310

Repair Kit

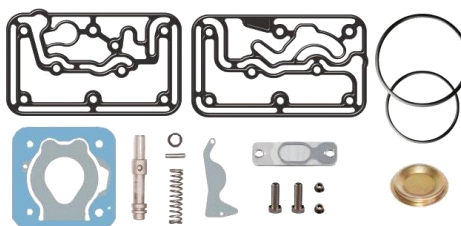

OEM Ref.

413.320

Repair Kit

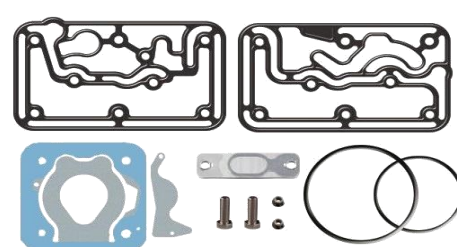

OEM Ref.

413.350

Gasket Kit

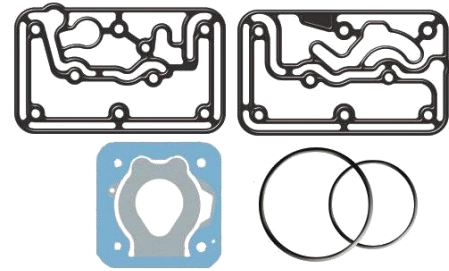

OEM Ref. 85102273 / 412 352 003 2

413.270

Cooling Plate



OEM Ref.

413.150

Crankcase



OEM Ref.

413.400

Valve Kit



OEM Ref.

101.410

Valve Kit



OEM Ref.

401.450

Connecting Rod

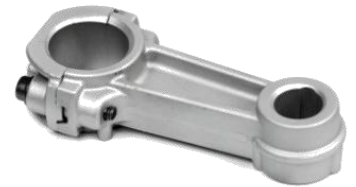

OEM Ref. 1698678 / 1317201
911 505 732 2

101.500

Ø 85,00 mm

Piston

101.510

Ø 85,25 mm

101.520

Ø 85,50 mm



OEM Ref.

101.550

Ø 85,00 mm

Piston & Ring

101.560

Ø 85,25 mm

101.570

Ø 85,50 mm



OEM Ref. 0697442 / 1698686 / 1283781 / FBU2076
000 130 34 17 / 911 501 624 2 / 911 501 625 2

101.600

Ø 85,00 mm

Ring

101.610

Ø 85,25 mm

101.620

Ø 85,50 mm



OEM Ref. 3094621
911 501 920 2

413.750

Bushing



OEM Ref.

413.800

Crankshaft



OEM Ref.

413.830

Crankshaft Flange



OEM Ref.

ASEL CODE	414.100
OEM Reference	20451727 / 21353433 / 9112 000 0 / 912 112 001 0
Kullanılan Araç Vehicle Application	FM9 / FM12 / FM16 / NH12



Technical Data	
Cylinder Bore	Ø 85.00 mm
Swept Volume	318 cc
Stroke	56 mm

414.200 Complete Cylinder Head



OEM Ref. 85104248 / 412 352 920 2

414.210 Cylinder Head



OEM Ref.

414.250 Plate



OEM Ref.

414.300 Full Repair Kit



OEM Ref.

414.310 Repair Kit

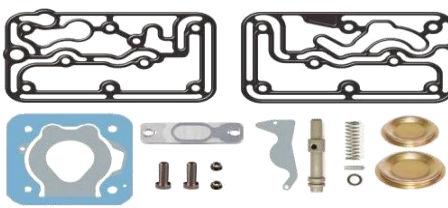

OEM Ref.

414.320 Repair Kit



OEM Ref.

414.350 Gasket Kit

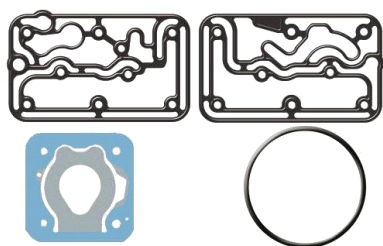

OEM Ref. 85103938 / 412 352 004 2

414.270 Cooling Plate



OEM Ref.

414.150 Crankcase



OEM Ref.

413.400 Valve Kit



OEM Ref.

101.410 Valve Kit



OEM Ref.

118.450 Connecting Rod



OEM Ref. 3357219 / 2VF145041
000 131 24 17 / 911 145 737 2

101.500 Ø 85,00 mm Piston



OEM Ref.

101.550 Ø 85,00 mm Piston & Ring



OEM Ref. 0697442 / 1698686 / 1283781 / FBU2076
000 130 34 17 / 911 501 624 2 / 911 501 625 2

101.600 Ø 85,00 mm Ring



OEM Ref. 3094621
911 501 920 2

101.510 Ø 85,25 mm

101.560 Ø 85,25 mm

101.610 Ø 85,25 mm

101.520 Ø 85,50 mm

101.570 Ø 85,50 mm

101.620 Ø 85,50 mm

410.760 Adapter



OEM Ref. 912 003 340 4 / 912 003 340 6

414.800 Crankshaft



OEM Ref.

410.820 Gear



OEM Ref. 3161258

ASEL CODE

414.110

OEM Reference

20382346 / 20478166 / 21353457 / 85000116 / 412 352 004 0 / 412 352 029 0

**Kullanılan Araç
Vehicle Application**

FM9



Technical Data

Cylinder Bore	Ø 85.00 mm
Swept Volume	352 cc
Stroke	62 mm

414.200

Complete Cylinder Head

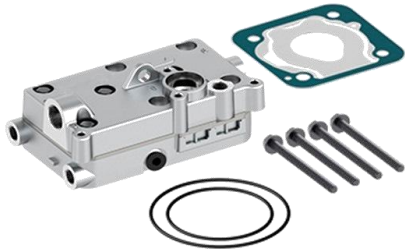

OEM Ref. 85104248 / 412 352 920 2

414.210

Cylinder Head



OEM Ref.

414.250

Plate



OEM Ref.

414.305

Full Repair Kit



OEM Ref.

414.315

Repair Kit



OEM Ref.

414.320

Repair Kit



OEM Ref.

414.350 Gasket Kit

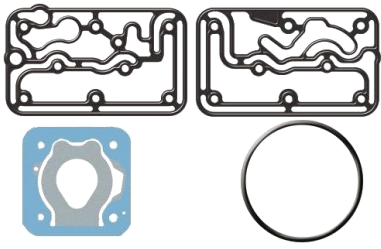

OEM Ref. 85103938 / 412 352 004 2

414.270 Cooling Plate



OEM Ref.

414.155 Crankcase



OEM Ref.

413.400 Valve Kit

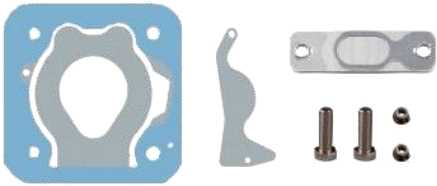

OEM Ref.

101.410 Valve Kit



OEM Ref.

401.450 Connecting Rod



OEM Ref. 1698678 / 1317201
911 505 732 2

101.500 Ø 85,00 mm Piston

101.510 Ø 85,25 mm

101.520 Ø 85,50 mm



OEM Ref.

101.550 Ø 85,00 mm Piston & Ring

101.560 Ø 85,25 mm

101.570 Ø 85,50 mm



OEM Ref. 0697442 / 1698686 / 1283781 / FBU2076
000 130 34 17 / 911 501 624 2 / 911 501 625 2

101.600 Ø 85,00 mm Ring

101.610 Ø 85,25 mm

101.620 Ø 85,50 mm



OEM Ref. 3094621
911 501 920 2

413.830 Crankshaft Flange



OEM Ref.

414.805 Crankshaft



OEM Ref.

410.820 Gear



OEM Ref. 3161258

ASEL CODE

415.100

OEM Reference

LP4812 / I86909000 / 1599999 / 5003217

**Kullanılan Araç
Vehicle Application**

B6 / B7 / B10 / B12 / F16 / FL6 / FL7 / FL10 / FS7



Technical Data

Cylinder Bore	Ø 75.00 mm
Swept Volume	440 cc
Stroke	50 mm

415.200

Complete Cylinder Head



OEM Ref.

415.210

Cylinder Head



OEM Ref. 1697771
SEB00421004

415.250

Plate

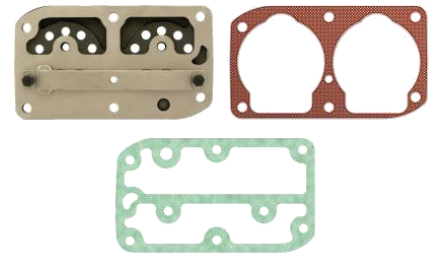

OEM Ref. 1697770 / 1697290
I81015004

415.300

Full Repair Kit

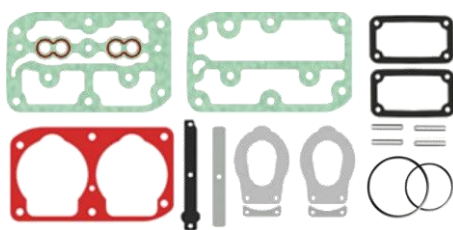

OEM Ref.

415.310

Repair Kit

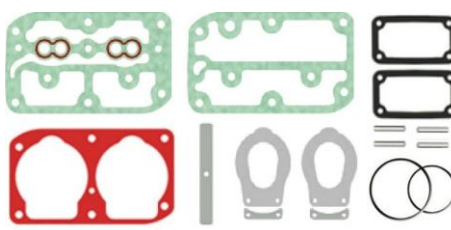

OEM Ref. SEB22541

415.320

Repair Kit

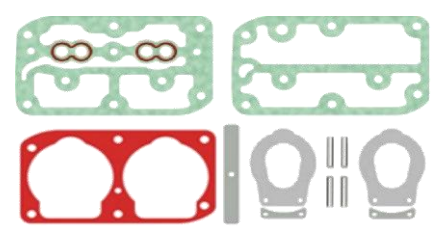

OEM Ref.

415.350 Gasket Kit

415.270 Cooling Plate

415.150 Crankcase

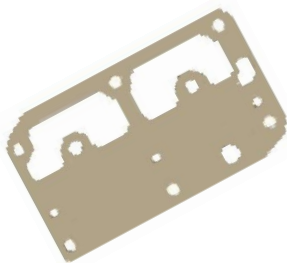
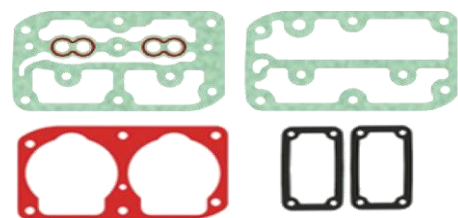

OEM Ref. SEB22542

OEM Ref.

OEM Ref.

415.400 Valve Kit

119.170 Nut

408.450 Connecting Rod

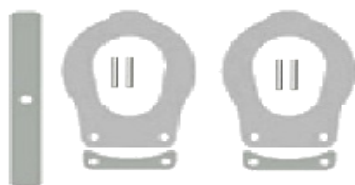

OEM Ref.

OEM Ref. 1698672 / 0698060 / 11712509
004 990 32 51 / 810 341 001 4

OEM Ref. 1697281 / 1698528 / 3090386
SEB00626004 / SEB00957004

109.500 Ø 75,00 mm Piston

109.550 Ø 75,00 mm Piston & Ring

109.600 Ø 75,00 mm Ring

109.510 Ø 75,25 mm

109.560 Ø 75,25 mm

109.610 Ø 75,25 mm

109.520 Ø 75,50 mm

109.570 Ø 75,50 mm

109.620 Ø 75,50 mm



OEM Ref.

OEM Ref. SEB22539 / SEB22540

OEM Ref. 3090388 / I801770061

408.800 Crankshaft

408.830 Crankshaft Flange

406.820 Gear



OEM Ref. 1697285
EB007622V

OEM Ref. 3090385 / 1697769
SEB00387004

OEM Ref. 478777 / 470775

ASEL CODE

415.110

OEM Reference

LP4813 / I90499000 / 1613632 / 5003336

**Kullanılan Araç
Vehicle Application**

B6 / B7R / B10B / B12 / F7 / F10 / F12 / F16 / FL7 / FL10 / FS7 / FH12 / FH16



Technical Data

Cylinder Bore	Ø 75.00 mm
Swept Volume	440 cc
Stroke	50 mm

415.201

Complete Cylinder Head



OEM Ref.

415.220

Cylinder Head



OEM Ref.

415.250

Plate

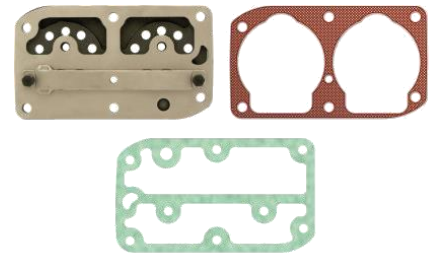

OEM Ref. 1697770 / 1697290
I81015004

415.300

Full Repair Kit

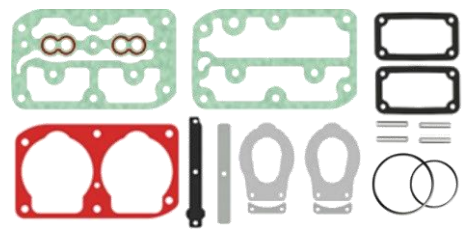

OEM Ref.

415.150

Crankcase



OEM Ref.

408.800

Crankshaft



OEM Ref. 1697285
EB007622V

ASEL CODE

416.100

OEM Reference

LK3930 / 1628592 / 8112583 / II18606000

**Kullanılan Araç
Vehicle Application**

FH12 / FH16 / F16



Technical Data

Cylinder Bore	Ø 88.00 mm
Swept Volume	300 cc
Stroke	50 mm

416.200

Complete Cylinder Head



OEM Ref.

416.210

Cylinder Head



OEM Ref.

304.250

Plate

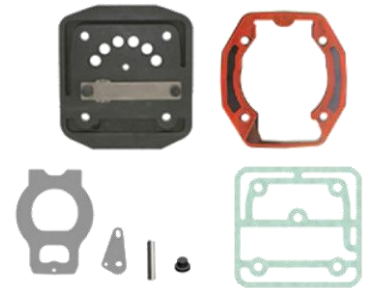

OEM Ref.

304.310

Full Repair Kit

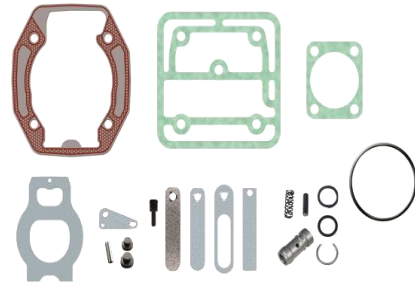

OEM Ref.

416.150

Crankcase



OEM Ref.

304.700

Cylinder Liner Kit



OEM Ref. K000998

ASEL CODE

417.100

OEM Reference

LK4954 / K017528 / 21101027 / 21040143

**Kullanılan Araç
Vehicle Application**

B7 / 3 SERIES BUS

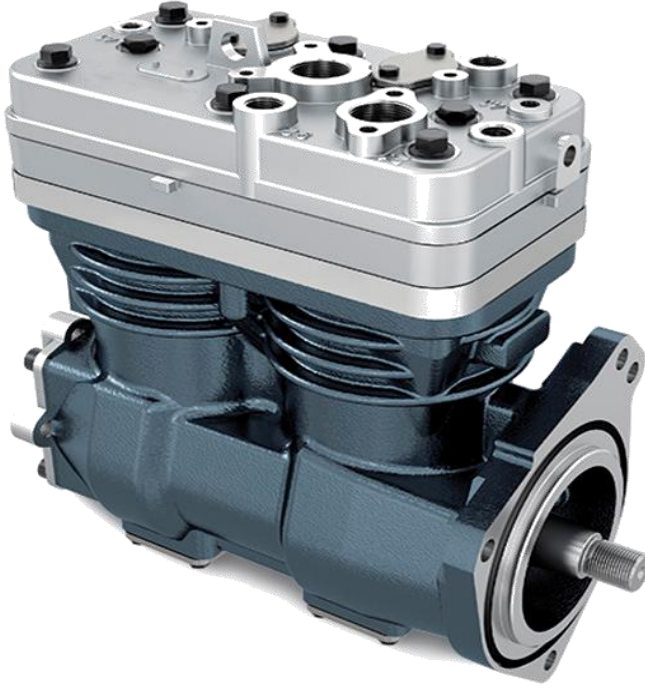

Technical Data

Cylinder Bore	Ø 92.00 mm
Swept Volume	720 cc
Stroke	54 mm

417.200

Complete Cylinder Head



OEM Ref. 7421136561 / 7422352649 / 21136561
K017529 / K009875

417.210

Cylinder Head



OEM Ref. K01752**

417.250

Plate

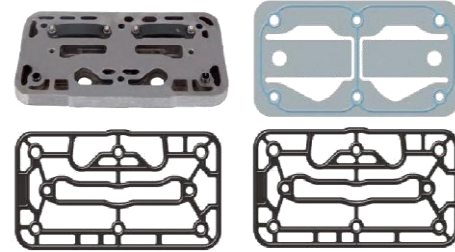

OEM Ref. K012074

417.270

Cooling Plate



OEM Ref.

417.300

Full Repair Kit

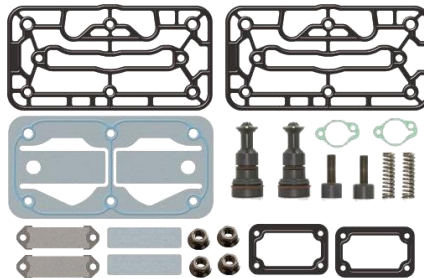

OEM Ref.

417.310

Repair Kit

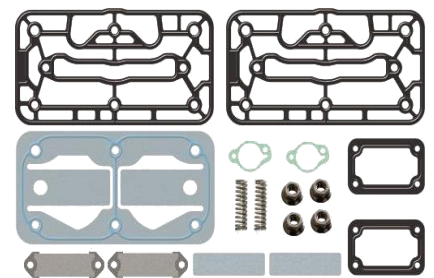

OEM Ref. K012086

417.320 **Repair Kit**

OEM Ref.

417.350 **Gasket Kit**

OEM Ref.

417.150 **Crankcase**

OEM Ref.

417.400 **Valve Kit**

OEM Ref.

124.400 **Valve Kit**

OEM Ref. K03474K50 / K159064K50

417.410 **Safety Valve**

OEM Ref.

214.500 **Ø 92,00 mm** **Piston**

214.510 **Ø 92,25 mm**

214.520 **Ø 92,50 mm**

OEM Ref.

214.550 **Ø 92,00 mm** **Piston & Ring**

214.560 **Ø 92,25 mm**

214.570 **Ø 92,50 mm**

OEM Ref. K006026 /K012079 /K012079K56 /K012079K57
SEB22530 / 51.54119-6008 /51.54119-6009 /7421136690

214.600 **Ø 92,00 mm** **Ring**

214.610 **Ø 92,25 mm**

214.620 **Ø 92,50 mm**

OEM Ref.

417.450 **Connecting Rod**

OEM Ref.

417.800 **Crankshaft**

OEM Ref.

417.830 **Crankshaft Flange**

OEM Ref.

ASEL CODE	418.100
OEM Reference	912 514 009 0 / 22062020 / 22062019
Kullanılan Araç Vehicle Application	FH16 / FM9 / FH16II

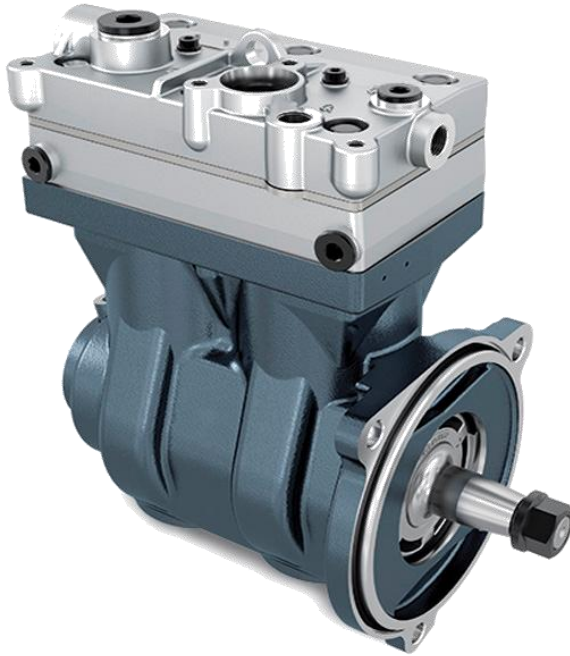

Technical Data	
Cylinder Bore	Ø 85.00 mm
Swept Volume	636 cc
Stroke	56 mm

418.200 Complete Cylinder Head

OEM Ref. 912 512 935 2

411.210 Cylinder Head

OEM Ref.

418.250 Plate

OEM Ref.

410.270 Cooling Plate

OEM Ref.

418.300 Full Repair Kit

OEM Ref.

418.310 Repair Kit

OEM Ref.

418.320 Repair Kit

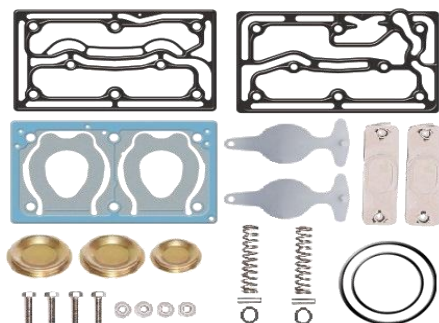

OEM Ref.

418.330 Repair Kit

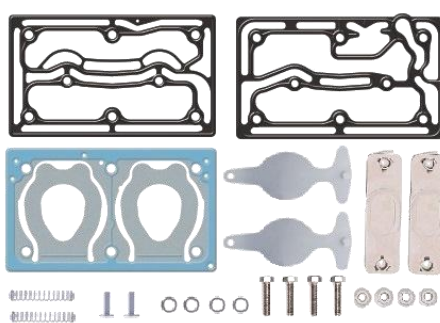

OEM Ref.

418.350 Gasket Kit

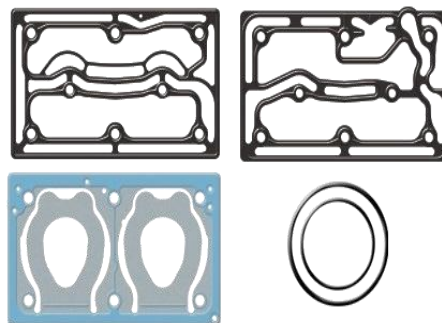

OEM Ref.

418.400 Valve Kit

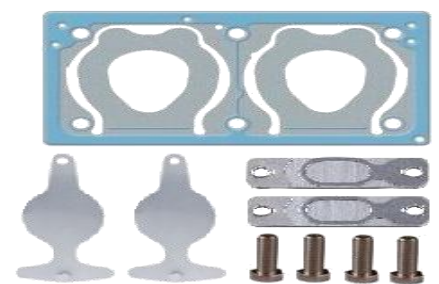

OEM Ref.

418.410 Valve Kit

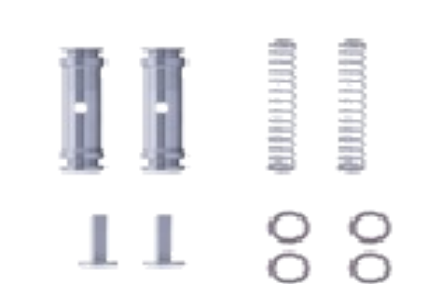

OEM Ref.

410.150 Crankcase



OEM Ref.

101.500 Ø 85,00 mm Piston

101.510 Ø 85,25 mm

101.520 Ø 85,50 mm



OEM Ref.

101.550 Ø 85,00 mm Piston & Ring

101.560 Ø 85,25 mm

101.570 Ø 85,50 mm



OEM Ref. 0697442 / 1698686 / 1283781 / FBU2076
000 130 34 17 / 911 501 624 2 / 911 501 625 2

101.600 Ø 85,00 mm Ring

101.610 Ø 85,25 mm

101.620 Ø 85,50 mm



OEM Ref. 3094621
911 501 920 2

118.450 Connecting Rod



OEM Ref. 3357219 / 2VF145041
000 131 24 17 / 911 145 737 2

410.800 Crankshaft



OEM Ref.

410.820 Gear



OEM Ref. 3161258

ASEL CODE

418.110

OEM Reference

412 704 027 0 / 412 704 027 R / 22040497

**Kullanılan Araç
Vehicle Application**

FH12 / FH16 / FM9 / FH16II / FM9 / B6 / B7 / B10

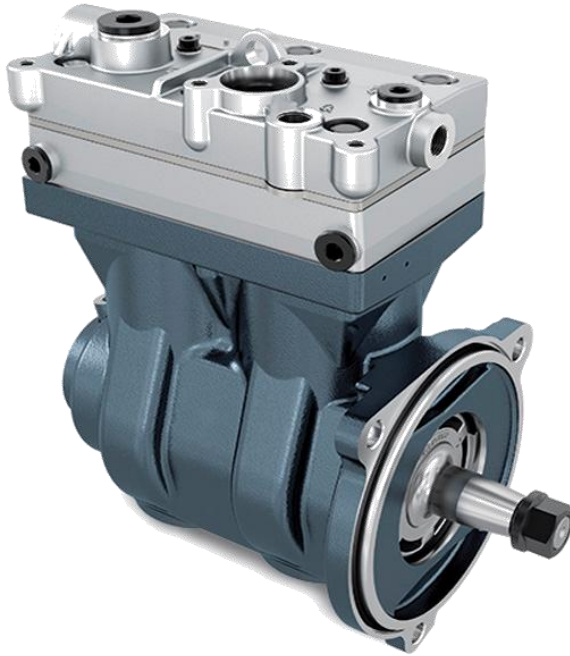

Technical Data

Cylinder Bore	Ø 85.00 mm
Swept Volume	704 cc
Stroke	62 mm

418.200

Complete Cylinder Head

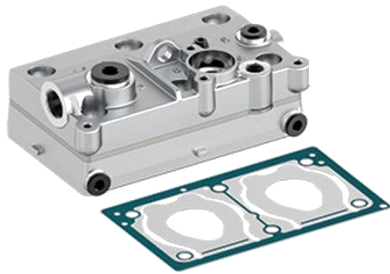

OEM Ref. 912 512 935 2

411.210

Cylinder Head



OEM Ref.

418.250

Plate



OEM Ref.

410.270

Cooling Plate



OEM Ref.

418.300

Full Repair Kit

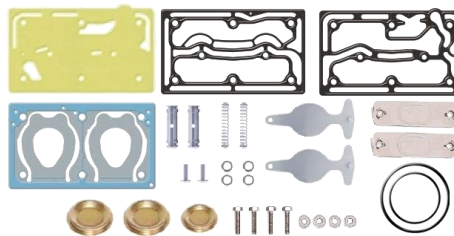

OEM Ref.

418.310

Repair Kit



OEM Ref.

418.320 Repair Kit

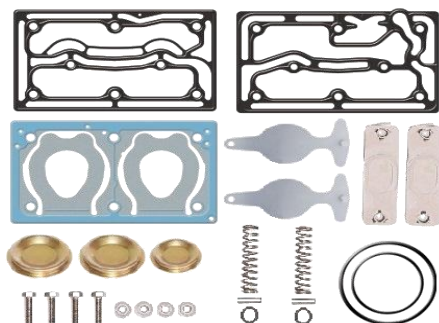

OEM Ref.

418.330 Repair Kit

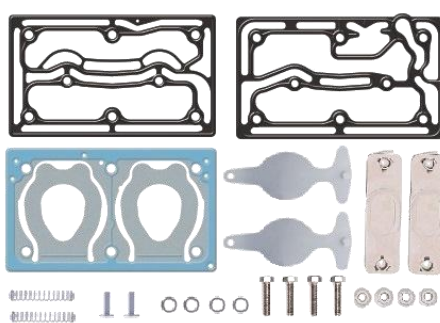

OEM Ref.

418.350 Gasket Kit

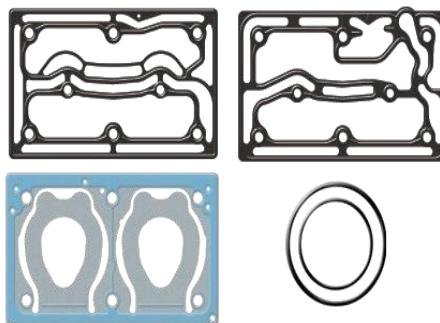

OEM Ref.

418.400 Valve Kit

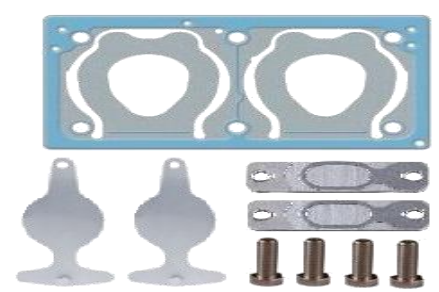

OEM Ref.

418.410 Valve Kit

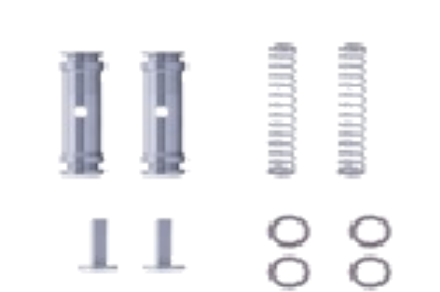

OEM Ref.

411.155 Crankcase



OEM Ref.

101.500 Ø 85,00 mm Piston

101.510 Ø 85,25 mm

101.520 Ø 85,50 mm



OEM Ref.

101.550 Ø 85,00 mm Piston & Ring

101.560 Ø 85,25 mm

101.570 Ø 85,50 mm



OEM Ref. 0697442 / 1698686 / 1283781 / FBU2076
000 130 34 17 / 911 501 624 2 / 911 501 625 2

101.600 Ø 85,00 mm Ring

101.610 Ø 85,25 mm

101.620 Ø 85,50 mm



OEM Ref. 3094621
911 501 920 2

411.450 Connecting Rod



OEM Ref. 3357219 / 2VF145041
000 131 24 17 / 911 145 737 2

411.805 Crankshaft



OEM Ref.

410.820 Gear



OEM Ref. 3161258

ASEL CODE**419.100****OEM Reference**

LK8907 / K093377N00 / K093377N06 / 21702066 / 22083113

**Kullanılan Araç
Vehicle Application**

FH EURO6 / FM EURO6 / FMX EURO6

**Technical Data**

Cylinder Bore	Ø 92.00 mm
Swept Volume	760 cc
Stroke	57 mm

419.250

Plate

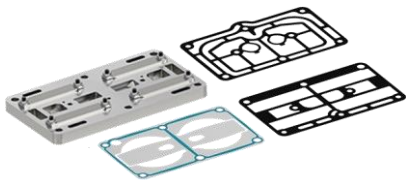

OEM Ref.

419.300

Full Repair Kit

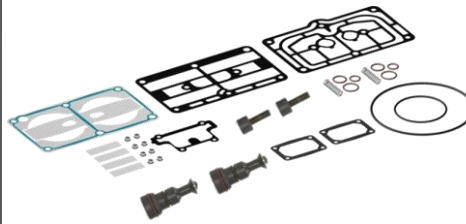

OEM Ref.

419.310

Repair Kit

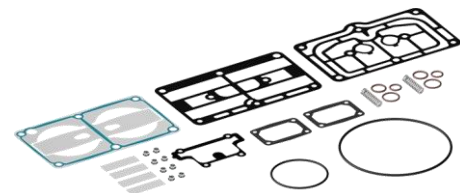

OEM Ref.

419.350

Gasket Kit

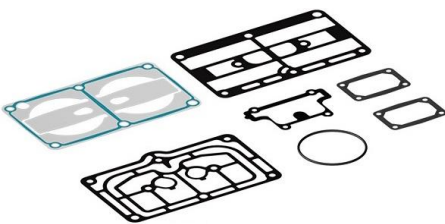

OEM Ref.

419.400

Valve Kit

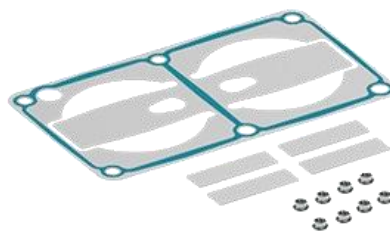

OEM Ref.

419.410

Valve Kit



OEM Ref.

ASEL CODE	420.100
OEM Reference	LK4979 / K088809N00 / K088809N06 / K088809N07 / 22040616
Kullanılan Araç Vehicle Application	FH EURO6 / FM EURO6 / FMX EURO6



Technical Data	
Cylinder Bore	∅ 92.00 mm
Swept Volume	720 cc
Stroke	54 mm

420.200 Complete Cylinder Head



OEM Ref.

420.210 Cylinder Head



OEM Ref.

417.250 Plate

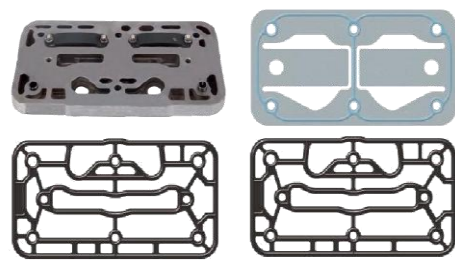

OEM Ref. 21136726 / K012074 / K099412K50

417.270 Cooling Plate



OEM Ref.

417.300 Full Repair Kit

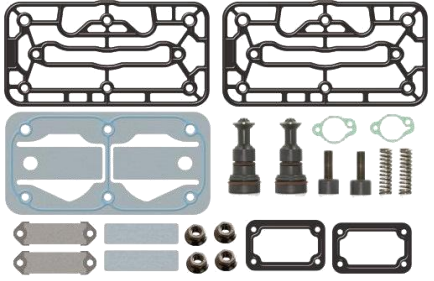

OEM Ref.

417.310 Repair Kit

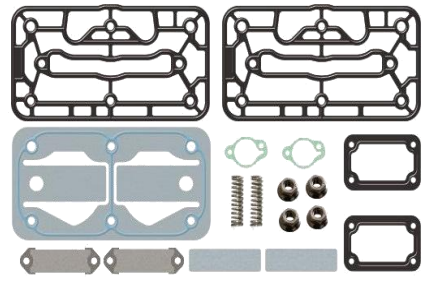

OEM Ref. K012086

ASEL CODE

421.100

OEM Reference

22040500 / 22169884 / 85020160 / 912 112 002 0 / 912 151 001 0 / 912 142 002 0

**Kullanılan Araç
Vehicle Application**

FM9 / FM12 / FH13 / FH16



Technical Data

Cylinder Bore	Ø 85.00 mm
Swept Volume	318 cc
Stroke	56 mm

421.200

Complete Cylinder Head

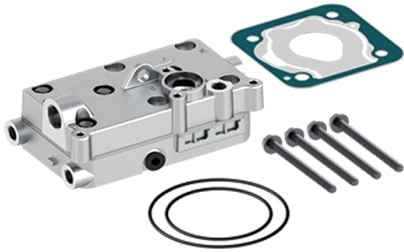

OEM Ref. 22433118

414.210

Cylinder Head



OEM Ref.

421.250

Plate



OEM Ref.

421.300

Full Repair Kit

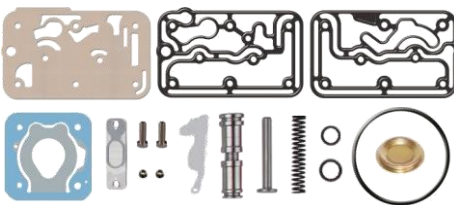

OEM Ref.

421.310

Repair Kit

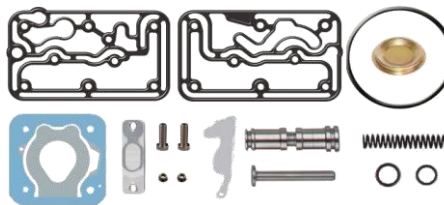

OEM Ref.

421.320

Repair Kit

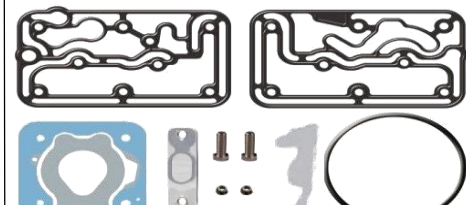

OEM Ref.

414.350 Gasket Kit

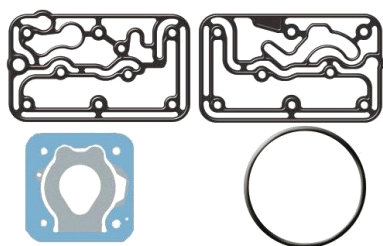

OEM Ref. 85103938 / 412 352 004 2

414.270 Cooling Plate



OEM Ref.

414.150 Crankcase



OEM Ref.

421.400 Valve Kit



OEM Ref.

421.410 Valve Kit



OEM Ref.

118.450 Connecting Rod



OEM Ref. 3357219 / 2VF145041
000 131 24 17 / 911 145 737 2

101.500 Ø 85,00 mm Piston

101.510 Ø 85,25 mm

101.520 Ø 85,50 mm



OEM Ref.

101.550 Ø 85,00 mm Piston & Ring

101.560 Ø 85,25 mm

101.570 Ø 85,50 mm



OEM Ref. 0697442 / 1698686 / 1283781 / FBU2076
000 130 34 17 / 911 501 624 2 / 911 501 625 2

101.600 Ø 85,00 mm Ring

101.610 Ø 85,25 mm

101.620 Ø 85,50 mm



OEM Ref. 3094621
911 501 920 2

119.170 Nut



OEM Ref. 1698672 / 0698060 / 11712509
004 990 32 51 / 810 341 001 4

414.800 Crankshaft



OEM Ref.

410.820 Gear



OEM Ref. 3161258

ASEL CODE

422.100

OEM Reference

LK3841 / K004640X00 / 20568592 / 85000344

Kullanılan Araç
Vehicle Application

FL6



asel
AIR BRAKE SYSTEMS



Technical Data

Cylinder Bore	Ø 80.00 mm
Swept Volume	225 cc
Stroke	45 mm

422.200

Complete Cylinder Head

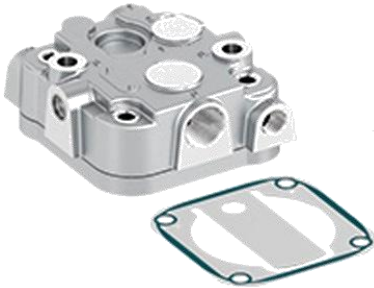

OEM Ref.

422.210

Cylinder Head



OEM Ref.

318.250

Plate



OEM Ref.

318.310

Full Repair Kit



OEM Ref.

318.320

Repair Kit

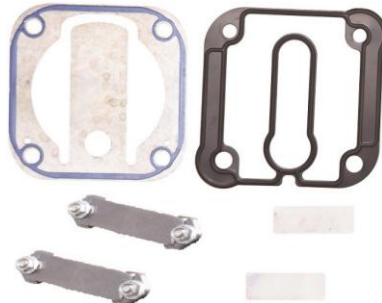

OEM Ref.

318.330

Repair Kit

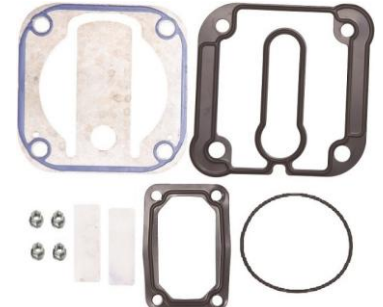

OEM Ref.

318.350 **Gasket Kit**

OEM Ref.

422.150 **Crankcase**

OEM Ref.

302.160 **Cover**

OEM Ref.

302.400 **Valve Kit**

OEM Ref.

408.450 **Connecting Rod**

OEM Ref. 1697281 / 1698528 / 3090386
SEB00626004 / SEB00957004

302.750 **Bushing**

OEM Ref.

302.500 **Ø 80,00 mm** **Piston**

302.510 **Ø 80,25 mm**

302.520 **Ø 80,50 mm**

OEM Ref.

302.550 **Ø 80,00 mm** **Piston & Ring**

302.560 **Ø 80,25 mm**

302.570 **Ø 80,50 mm**

OEM Ref. SEB22517

302.600 **Ø 80,00 mm** **Ring**

302.610 **Ø 80,25 mm**

302.620 **Ø 80,50 mm**

OEM Ref.

422.800 **Crankshaft**

OEM Ref.

422.820 **Gear**

OEM Ref. 3169496

405.830 **Crankshaft Flange**

OEM Ref. 3097150
11159920065 / SEB013090065

ASEL CODE	423.100
OEM Reference	911 505 150 0 / 1626060 / 5003460 / 1506365
Kullanılan Araç Vehicle Application	F7 / F10 / F12 / F16 / FL10 / NL12 / FM10



Technical Data	
Cylinder Bore	Ø 85.00 mm
Swept Volume	704 cc
Stroke	62 mm

423.200 Complete Cylinder Head



OEM Ref. 3094622 / 911 505 804 2

423.210 Cylinder Head



OEM Ref.

423.250 Plate



OEM Ref. 911 505 657 2

423.300 Full Repair Kit



OEM Ref.

423.310 Repair Kit

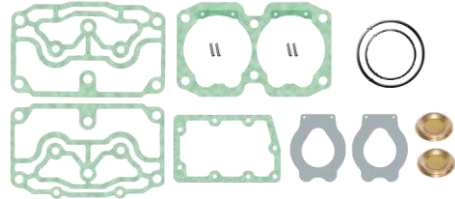

OEM Ref.

423.320 Repair Kit

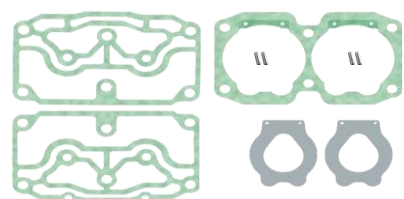

OEM Ref.

423.350 Gasket Kit

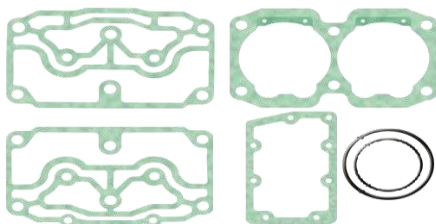

OEM Ref. 85104629 / 911 505 001 2

423.150 Crankcase



OEM Ref.

423.160 Cover



OEM Ref.

423.400 Valve Kit



OEM Ref.

423.410 Valve Kit



OEM Ref.

401.450 Connecting Rod



OEM Ref. 1698678 / 1317201
911 505 732 2

423.500 Ø 85,00 mm Piston

423.510 Ø 85,25 mm

423.520 Ø 85,50 mm



OEM Ref.

423.550 Ø 85,00 mm Piston & Ring

423.560 Ø 85,25 mm

423.570 Ø 85,50 mm



OEM Ref.

101.600 Ø 85,00 mm Ring

101.610 Ø 85,25 mm

101.620 Ø 85,50 mm



OEM Ref. 3094621
911 501 920 2

423.800 Crankshaft



OEM Ref. 1698670 / 911 505 691 4

406.820 Gear



OEM Ref. 478777 / 470775

423.830 Crankshaft Flange



OEM Ref.

ASEL CODE	423.110
OEM Reference	911 505 151 0 / 1518141 / 3037344 / 8112426
Kullanılan Araç Vehicle Application	BUS COACH / F7 / F10 / F12 / F16 / FL10 / NL12 / FM10



Technical Data	
Cylinder Bore	Ø 85.00 mm
Swept Volume	704 cc
Stroke	62 mm

423.200 Complete Cylinder Head



OEM Ref. 3094622 / 911 505 804 2

423.210 Cylinder Head



OEM Ref.

423.250 Plate



OEM Ref. 911 505 657 2

423.300 Full Repair Kit



OEM Ref.

423.310 Repair Kit

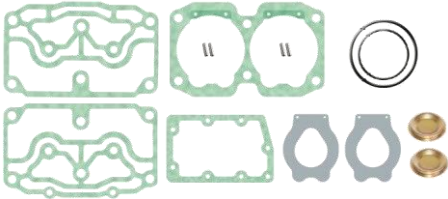

OEM Ref.

423.320 Repair Kit

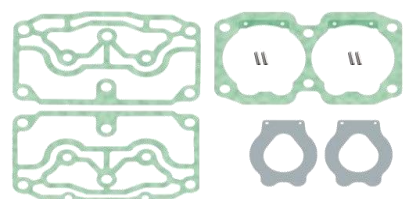

OEM Ref.

423.350

Gasket Kit

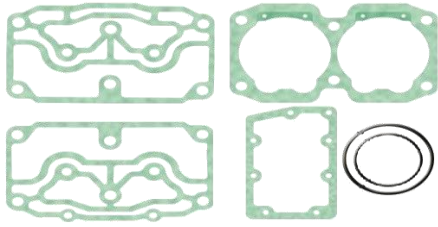

OEM Ref. 85104629 / 911 505 001 2

423.155

Crankcase



OEM Ref.

423.160

Cover



OEM Ref.

423.400

Valve Kit

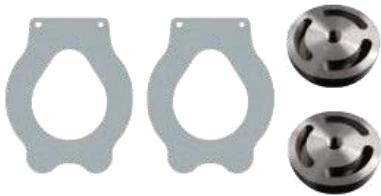

OEM Ref.

423.410

Valve Kit



OEM Ref.

401.450

Connecting Rod



OEM Ref. 1698678 / 1317201
911 505 732 2

423.500

Ø 85,00 mm

Piston

423.510

Ø 85,25 mm

423.520

Ø 85,50 mm



OEM Ref.

423.550

Ø 85,00 mm

Piston & Ring

423.560

Ø 85,25 mm

423.570

Ø 85,50 mm



OEM Ref.

101.600

Ø 85,00 mm

Ring

101.610

Ø 85,25 mm

101.620

Ø 85,50 mm



OEM Ref. 3094621
911 501 920 2

423.800

Crankshaft



OEM Ref. 1698670 / 911 505 691 4

406.820

Gear



OEM Ref. 478777 / 470775

423.830

Crankshaft Flange



OEM Ref.



DAF

KOMPRESOR YEDEK PARÇALARI
COMPRESSOR SPARE PARTS

www.asetr.com

İÇİNDEKİLER / INDEX

Sayfa No / Page No

DAF

XF95 / CF75 / CF85 / CKD / F75	218-219
XF95 / F75 / F95 / 85CF / CF85C / CF85II / 1260V / TBR2175	220-221
XF95 / F75 / F95 / 85CF / CF85II / 1260V / TBR2175 / VDL BUS / 1260PP	222
DAF / FH12 / FH16 / FM12 / NH12	223
CF75 / EURO 4	224-225
825AVM / 865AVM / 85CF	226
DAF F75 / F85 / F95	227
95XF / 95XF 400 / 430CV / F95 400	228-229
95 380 / 95XF / 95XF 400 / 430CV	230-231
3300ATI / 3600ATI / 2800ATI	232-233
XF105 / CF85 / TEMSA SAFIR / PACCAN ENGINE	234-235
ATI3300 / 310CV / 350CV / F95 330 / 95XF	236-237
XF105 / CF85 / TEMSA SAFIR / PACCAR ENGINE / EURO 6	238-239
XF106 / TEMSA SAFIR / PACCAR ENGINE EURO 6	240
LF45 / LF55	241

ASEL CODE

501.100

OEM Reference

911 504 500 0 / 911 504 501 0 / 911 504 503 0 / 1310523 / 1451651

**Kullanılan Araç
Vehicle Application**

XF95 / CF75 / CF85 / CKD / F75

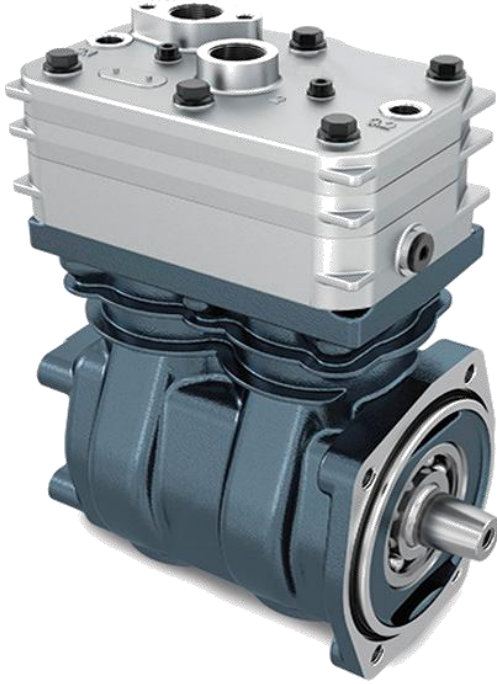

Technical Data

Cylinder Bore	Ø 75.00 mm
Swept Volume	442 cc
Stroke	50 mm

501.200

Complete Cylinder Head



OEM Ref. 1331137 / 1335748 / 1458906
911 504 801 2 / 911 504 803 2

501.210

Cylinder Head



OEM Ref.

501.250

Plate



OEM Ref.

501.270

Cooling Plate



OEM Ref.

501.300

Full Repair Kit

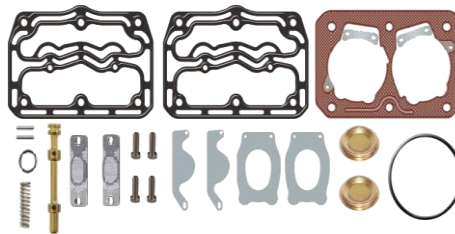

OEM Ref.

501.310

Repair Kit

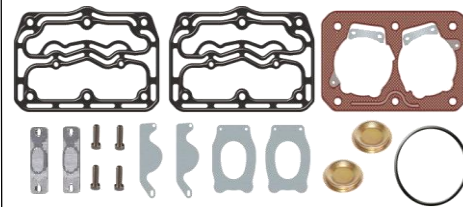

OEM Ref.

501.320 Repair Kit

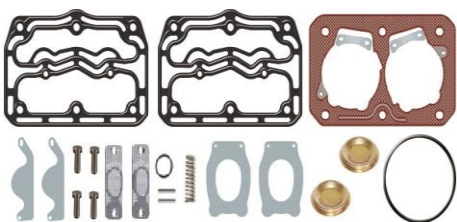

OEM Ref.

501.350 Gasket Kit

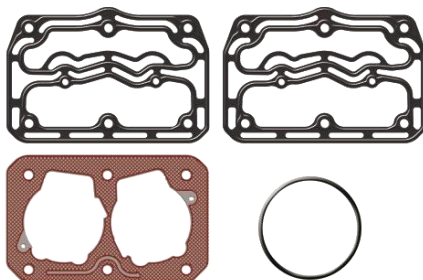

OEM Ref.

501.150 Crankcase



OEM Ref.

501.400 Valve Kit

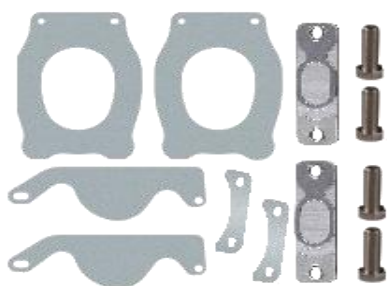

OEM Ref.

501.410 Valve Kit



OEM Ref.

501.450 Connecting Rod



OEM Ref. 1331136 / 93160591 / 41331136
911 145 735 2

501.500 Ø 75,00 mm Piston



OEM Ref.

501.550 Ø 75,00 mm Piston & Ring



OEM Ref. 0513860 / 1242704 / 5000816053 / FBU7209
411 141 623 2 / 411 522 620 2

501.510 Ø 75,25 mm

501.560 Ø 75,25 mm

501.520 Ø 75,50 mm

501.570 Ø 75,50 mm

109.600 Ø 75,00 mm Ring



OEM Ref. 1391384 / 1391385
3090388 / I801770061

109.610 Ø 75,25 mm

109.620 Ø 75,50 mm

501.750 Bushing



OEM Ref. 1315390 / 3291442r1 / 01306569 / 4285416
000 131 21 50 / 81.54121-005 / 411 522 340 4

501.800 Crankshaft



OEM Ref. 1349208 / 911 504 696 4

501.820 Gear



OEM Ref. 1205112

ASEL CODE

502.100

OEM Reference

911 504 504 0 / 911 504 505 0 / 911 504 506 0 / 1736785

**Kullanılan Araç
Vehicle Application**

XF95 / F75 / F95 / 85CF / CF85C / CF85II / 1260V / TBR2175

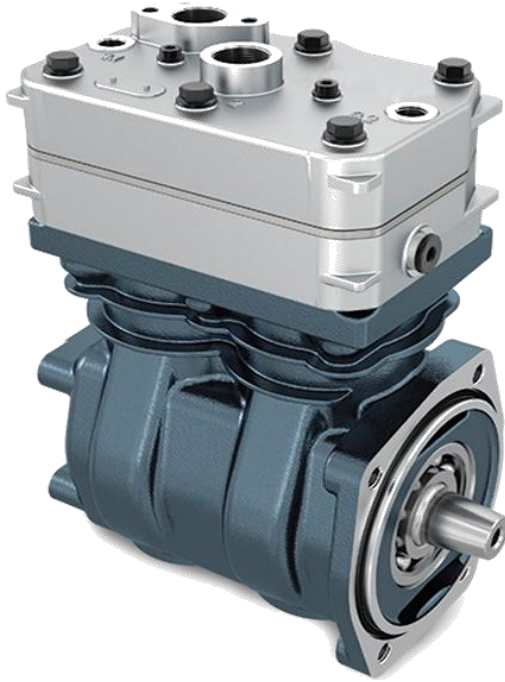

Technical Data

Cylinder Bore	Ø 75.00 mm
Swept Volume	442 cc
Stroke	50 mm

502.200

Complete Cylinder Head



OEM Ref. 1743267
412 442 000 2

502.210

Cylinder Head



OEM Ref.

502.250

Plate



OEM Ref.

502.270

Cooling Plate



OEM Ref.

502.300

Full Repair Kit

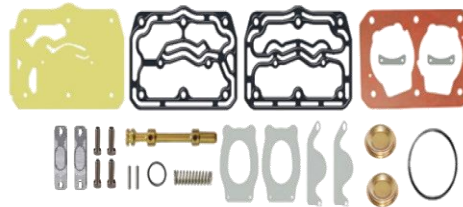

OEM Ref.

502.310

Repair Kit

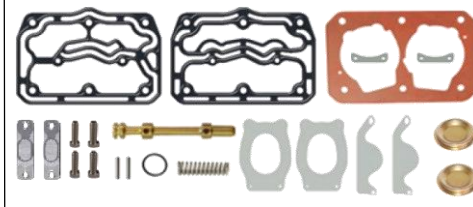

OEM Ref.

502.320 Repair Kit



OEM Ref.

502.350 Gasket Kit

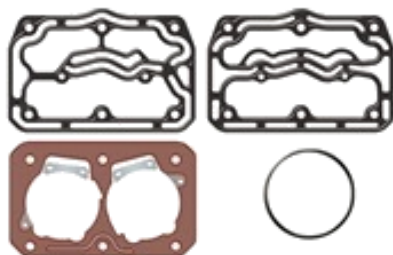

OEM Ref.

501.150 Crankcase



OEM Ref.

501.400 Valve Kit

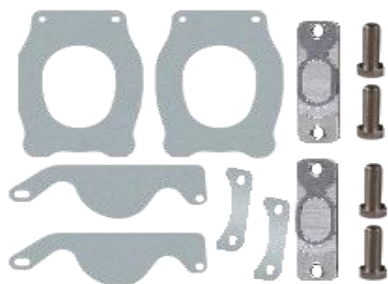

OEM Ref.

501.410 Valve Kit



OEM Ref.

501.450 Connecting Rod



OEM Ref. 1331136 / 93160591 / 41331136
911 145 735 2

501.500 Ø 75,00 mm Piston



OEM Ref.

501.550 Ø 75,00 mm Piston & Ring



OEM Ref. 0513860 / 1242704 / 5000816053 / FBU7209
411 141 623 2 / 411 522 620 2

109.600 Ø 75,00 mm Ring



OEM Ref. 1391384 / 1391385
3090388 / I801770061

501.510 Ø 75,25 mm

501.560 Ø 75,25 mm

109.610 Ø 75,25 mm

501.520 Ø 75,50 mm

501.570 Ø 75,50 mm

109.620 Ø 75,50 mm

501.750 Bushing



OEM Ref. 1315390 / 3291442r1 / 01306569 / 4285416
000 131 21 50 / 81.54121-005 / 411 522 340 4

501.800 Crankshaft



OEM Ref. 1349208 / 911 504 696 4

501.820 Gear



OEM Ref. 1205112

ASEL CODE

502.110

OEM Reference

1604420

**Kullanılan Araç
Vehicle Application**

XF95 / F75 / F95 / 85CF / CF85C / CF85II / 1260V / TBR2175 / VDL BUS / 1260PP



Technical Data

Cylinder Bore	Ø 75.00 mm
Swept Volume	442 cc
Stroke	50 mm

502.205

Complete Cylinder Head



OEM Ref. 1737654
911 504 920 2 / 911 504 921 2

502.220

Cylinder Head



OEM Ref.

502.250

Plate



OEM Ref.

502.270

Cooling Plate



OEM Ref.

502.300

Full Repair Kit



OEM Ref.

501.150

Crankcase



OEM Ref.

ASEL CODE

503.100

OEM Reference

1516708 / 1505917 / 412 704 008 0 / 412 704 004 0 / 412 704 005 0

**Kullanılan Araç
Vehicle Application**

DAF / FH12 / FH16 / FM12 / NH12

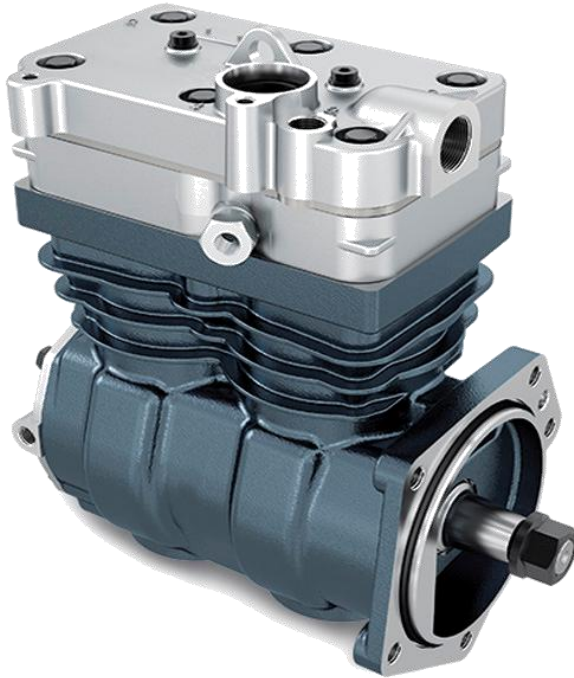

Technical Data

Cylinder Bore	Ø 85.00 mm
Swept Volume	704 cc
Stroke	62 mm

403.200

Complete Cylinder Head

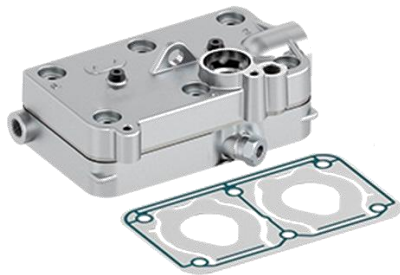

OEM Ref. 20701803 / 20701801 / 20569226
412 704 932 2 / 412 704 925 2 / 412 704 927 2

403.210

Cylinder Head



OEM Ref.

403.250

Plate



OEM Ref.

403.270

Cooling Plate



OEM Ref.

403.300

Full Repair Kit

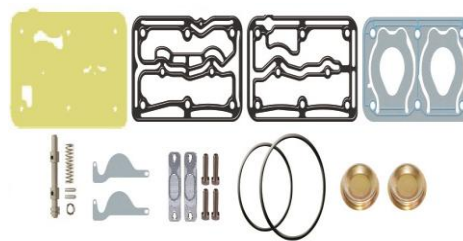

OEM Ref.

403.310

Repair Kit

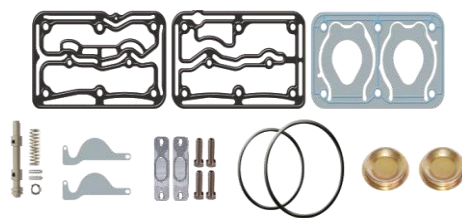

OEM Ref.

ASEL CODE

504.100

OEM Reference

912 518 200 0 / 912 518 202 0 / 912 518 204 0 / 912 518 206 0 / 1813541 / 1795776

**Kullanılan Araç
Vehicle Application**

CF75 / EURO4



Technical Data

Cylinder Bore	Ø 85.00 mm
Swept Volume	476 cc
Stroke	42 mm

504.200

Complete Cylinder Head

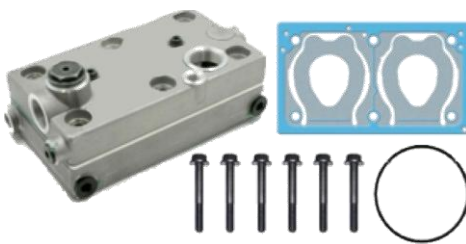

OEM Ref. 1732080
912 518 922 2

504.210

Cylinder Head



OEM Ref.

102.250

Plate



OEM Ref.

102.270

Cooling Plate



OEM Ref.

504.300

Full Repair Kit

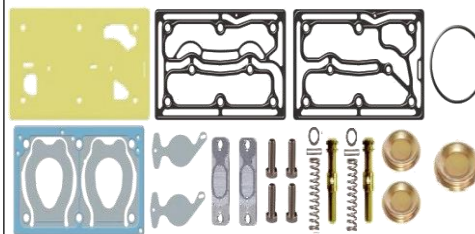

OEM Ref.

504.310

Repair Kit



OEM Ref.

504.320 **Repair Kit**

OEM Ref.

504.350 **Gasket Kit**

OEM Ref.

504.150 **Crankcase**

OEM Ref.

102.400 **Valve Kit**

OEM Ref.

102.410 **Valve Kit**

OEM Ref.

101.450 **Connecting Rod**

OEM Ref. 911 145 738 2

101.500 **Ø 85,00 mm** **Piston**

101.510 **Ø 85,25 mm**

101.520 **Ø 85,50 mm**

OEM Ref.

101.550 **Ø 85,00 mm** **Piston & Ring**

101.560 **Ø 85,25 mm**

101.570 **Ø 85,50 mm**

OEM Ref. 0697442 / 1698686 / 1283781 / FBU2076
000 130 34 17 / 911 501 624 2 / 911 501 625 2

101.600 **Ø 85,00 mm** **Ring**

101.610 **Ø 85,25 mm**

101.620 **Ø 85,50 mm**

OEM Ref. 3094621
911 501 920 2

504.800 **Crankshaft**

OEM Ref.

504.820 **Gear**

OEM Ref. 1745228

504.830 **Bearing Flange**

OEM Ref.

ASEL CODE	505.100
OEM Reference	LP4969 / II34404 / 1320400
Kullanılan Araç Vehicle Application	825 AVM / 865 AVM / 85CF



Technical Data	
Cylinder Bore	∅ 88.00 mm
Swept Volume	600 cc
Stroke	50 mm

505.200 Complete Cylinder Head



OEM Ref.

505.210 Cylinder Head



OEM Ref.

406.250 Plate

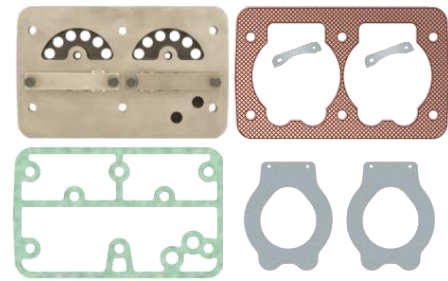

OEM Ref. 3095845
SEB01034004

406.300 Full Repair Kit



OEM Ref.

406.310 Repair Kit



OEM Ref.

406.320 Repair Kit



OEM Ref.

ASEL CODE**506.100****OEM Reference**

LP4823 / II34840 / 1241874 / 1321470 / 1396290

**Kullanılan Araç
Vehicle Application**

DAF F75 / F85 / F95

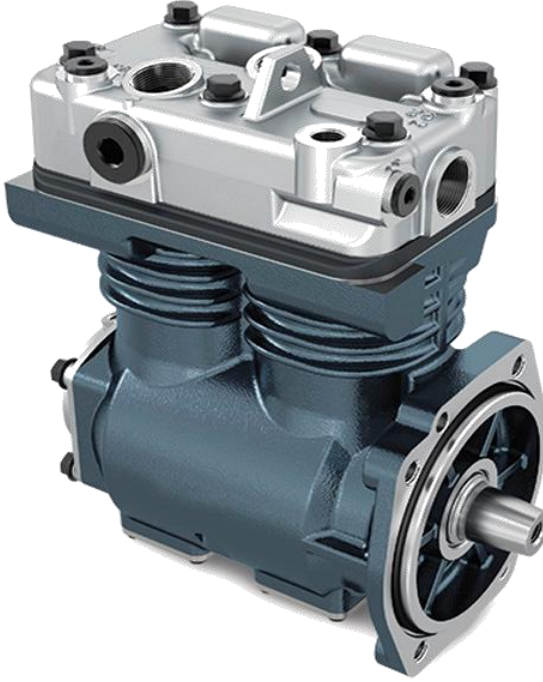
**Technical Data**

Cylinder Bore	Ø 75.00 mm
Swept Volume	440 cc
Stroke	50 mm

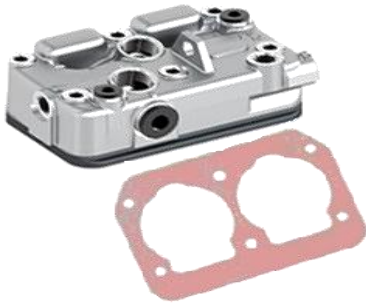
506.200**Complete Cylinder Head**

OEM Ref.

506.210**Cylinder Head**

OEM Ref.

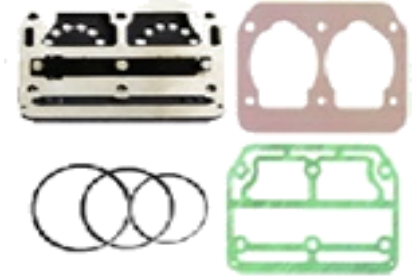
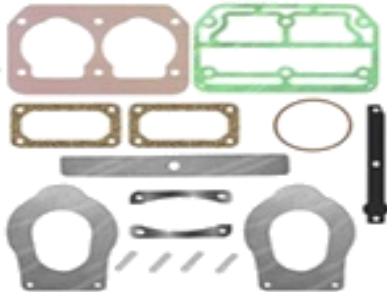
408.250**Plate**OEM Ref. 8127751
SEB01000004**408.300****Full Repair Kit**

OEM Ref.

408.830**Crankshaft Flange**OEM Ref. 3090385 / 1697769
SEB00387004**501.150****Crankcase**

OEM Ref.

ASEL CODE

507.100

OEM Reference

911 504 059 0 / 911 504 060 0 / 1298052 / 1373425 / 20242585

**Kullanılan Araç
Vehicle Application**

95XF / 95XF400 / 430CV / F95400



Technical Data

Cylinder Bore	Ø 75.00 mm
Swept Volume	440 cc
Stroke	50 mm

507.200

Complete Cylinder Head



OEM Ref. 1253530 / 911 503 805 2

507.210

Cylinder Head



OEM Ref.

507.250

Plate



OEM Ref.

507.300

Full Repair Kit

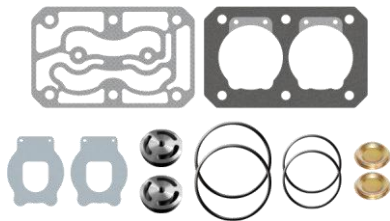

OEM Ref.

507.310

Repair Kit

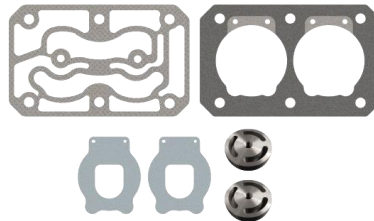

OEM Ref.

507.320

Repair Kit

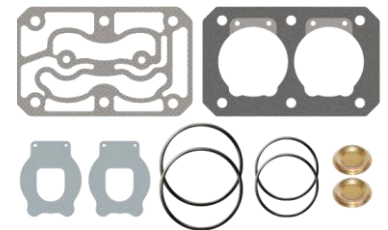

OEM Ref.

507.350 Gasket Kit

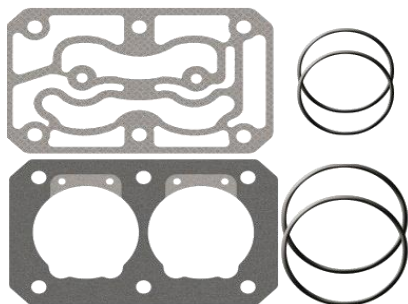

OEM Ref.

507.150 Crankcase



OEM Ref.

413.750 Bushing



OEM Ref.

507.400 Valve Kit



OEM Ref.

507.410 Valve Kit



OEM Ref.

507.450 Connecting Rod

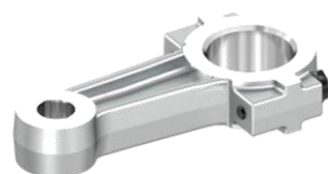

OEM Ref. 1304884
411 144 735 2 / 411 144 731 2

501.500 Ø 75,00 mm Piston



OEM Ref.

501.550 Ø 75,00 mm Piston & Ring



OEM Ref. 0513860 / 1242704 / 5000816053 / FBU7209
411 141 623 2 / 411 522 620 2

109.600 Ø 75,00 mm Ring



OEM Ref. 1391384 / 1391385
3090388 / I801770061

501.510 Ø 75,25 mm

501.560 Ø 75,25 mm

109.610 Ø 75,25 mm

501.520 Ø 75,50 mm

501.570 Ø 75,50 mm

109.620 Ø 75,50 mm

507.800 Crankshaft



OEM Ref.

507.830 Crankshaft Flange



OEM Ref.

507.750 Bushing



OEM Ref. 1253536 / 1304463 / 006975
911 504 340 4

ASEL CODE

508.100

OEM Reference

911 504 056 0 / 1243571

**Kullanılan Araç
Vehicle Application**

95 380 / 95XF / 95XF400 / 430CV



Technical Data

Cylinder Bore	Ø 75.00 mm
Swept Volume	440 cc
Stroke	50 mm

507.200

Complete Cylinder Head



OEM Ref. 1253530
911 503 805 2

507.210

Cylinder Head



OEM Ref.

507.250

Plate



OEM Ref.

508.300

Full Repair Kit

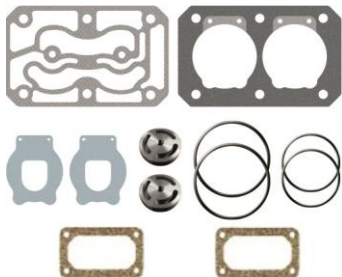

OEM Ref.

508.310

Repair Kit

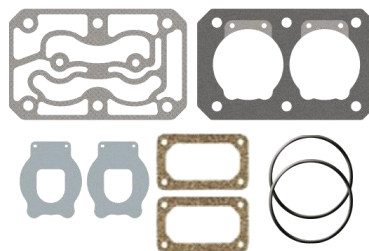

OEM Ref.

508.350

Gasket Kit

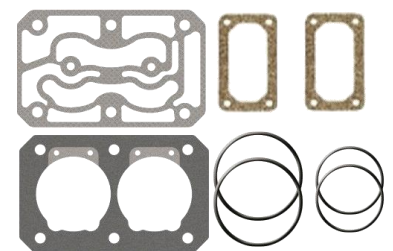

OEM Ref.

508.150 Crankcase



OEM Ref.

413.750 Bushing



OEM Ref.

507.450 Connecting Rod

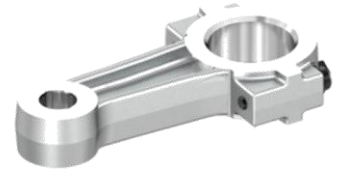

OEM Ref. 1304884
411 144 735 2 / 411 144 731 2

507.400 Valve Kit



OEM Ref.

507.410 Valve Kit



OEM Ref.

507.800 Crankshaft



OEM Ref.

501.500 Ø 75,00 mm Piston



OEM Ref.

501.550 Ø 75,00 mm Piston & Ring



OEM Ref. 0513860 / 1242704 / 5000816053 / FBU7209
411 141 623 2 / 411 522 620 2

501.510 Ø 75,25 mm

501.560 Ø 75,25 mm

501.520 Ø 75,50 mm

501.570 Ø 75,50 mm

109.600 Ø 75,00 mm Ring



OEM Ref. 1391384 / 1391385
3090388 / I801770061

109.610 Ø 75,25 mm

109.620 Ø 75,50 mm

508.800 Crankshaft Flange

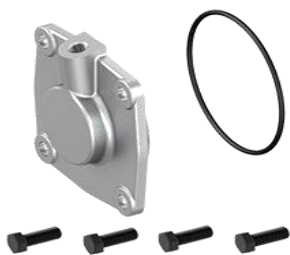

OEM Ref.

OEM Ref.

OEM Ref.

ASEL CODE

509.100

OEM Reference

911 501 060 0 / 911 501 061 0 / 555097 / 555098

**Kullanılan Araç
Vehicle Application**

3300 ATI / 3600 ATI / 2800 ATI



Technical Data

Cylinder Bore	Ø 85.00 mm
Swept Volume	510 cc
Stroke	45 mm

509.200

Complete Cylinder Head

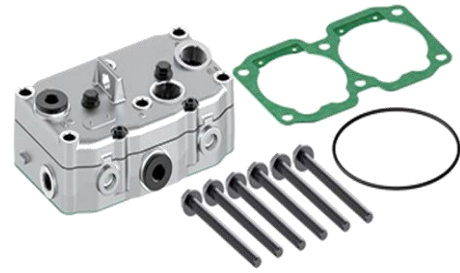

OEM Ref.

509.300

Full Repair Kit

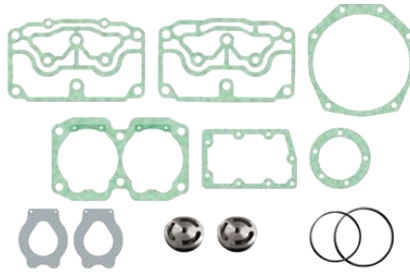

OEM Ref.

509.310

Repair Kit

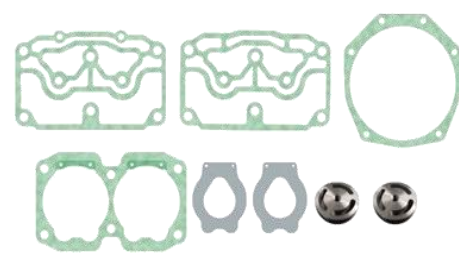

OEM Ref.

509.320

Repair Kit

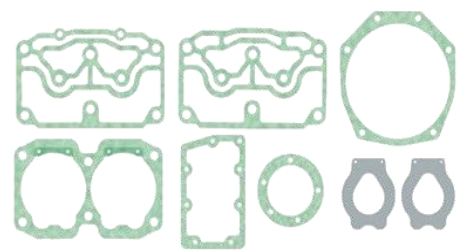

OEM Ref.

509.350

Gasket Kit

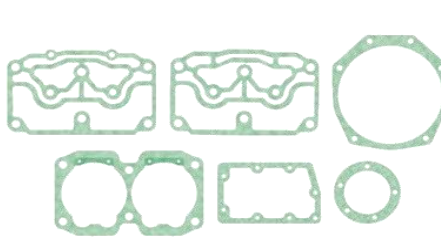

OEM Ref.

509.150

Crankcase



OEM Ref.

423.160 Cover



OEM Ref.

509.400 Valve Kit



OEM Ref.

507.410 Valve Kit



OEM Ref.

509.450 Connecting Rod



OEM Ref. 911 501 733 2

509.800 Crankshaft



OEM Ref.

508.450 Crankshaft Flange



OEM Ref.

423.500 Ø 85,00 mm Piston

423.510 Ø 85,25 mm

423.520 Ø 85,50 mm



OEM Ref.

423.550 Ø 85,00 mm Piston & Ring

423.560 Ø 85,25 mm

423.570 Ø 85,50 mm



OEM Ref.

101.600 Ø 85,00 mm Ring

101.610 Ø 85,25 mm

101.620 Ø 85,50 mm



OEM Ref. 3094621
911 501 920 2

OEM Ref.

OEM Ref.

OEM Ref.

ASEL CODE

510.100

OEM Reference

912 518 000 0 / 912 518 001 0 / 912 518 002 0 / 912 518 004 0 / 1674920 / 1681561

**Kullanılan Araç
Vehicle Application**

XF105 / CF85 / TEMSA SAFIR / PACCAR ENGINE

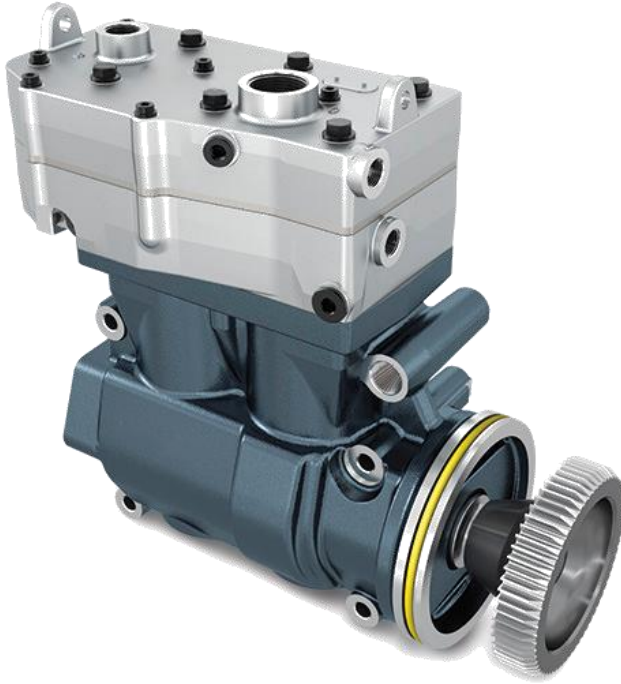

Technical Data

Cylinder Bore	Ø 85.00 mm
Swept Volume	352-119 cc
Stroke	62-21 mm

510.200

Complete Cylinder Head

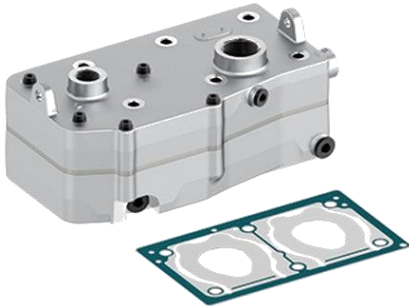

OEM Ref. 1679247
912 518 920 2

510.210

Cylinder Head



OEM Ref.

510.250

Plate

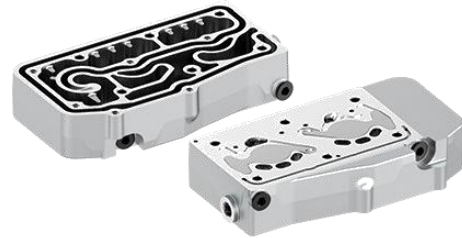

OEM Ref.

510.270

Cooling Plate



OEM Ref.

510.300

Full Repair Kit

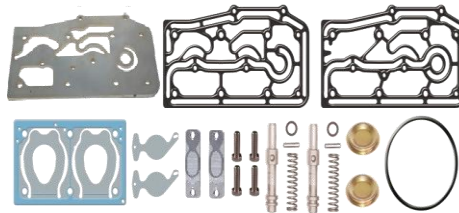

OEM Ref.

510.310

Repair Kit

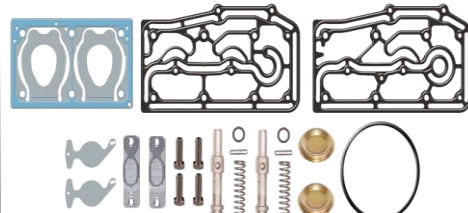

OEM Ref.

510.320 Repair Kit

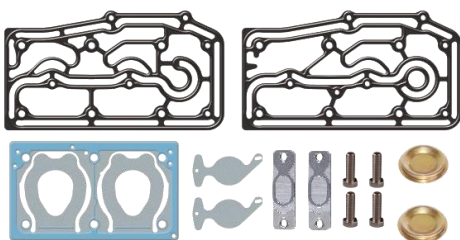

OEM Ref.

510.350 Gasket Kit

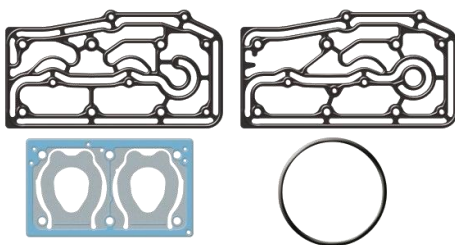

OEM Ref.

510.150 Crankcase



OEM Ref. 912 518 011 6

102.400 Valve Kit

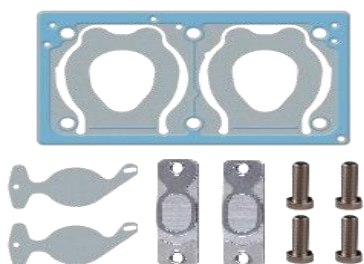

OEM Ref.

510.410 Valve Kit

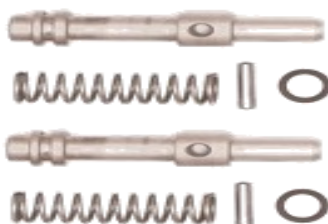

OEM Ref.

510.760 Adapter



OEM Ref. 911 902 013 4

101.500 Ø 85,00 mm Piston



OEM Ref.

101.550 Ø 85,00 mm Piston & Ring



OEM Ref. 0697442 / 1698686 / 1283781 / FBU2076
000 130 34 17 / 911 501 624 2 / 911 501 625 2

101.600 Ø 85,00 mm Ring



OEM Ref. 3094621
911 501 920 2

101.510 Ø 85,25 mm

101.560 Ø 85,25 mm

101.610 Ø 85,25 mm

101.520 Ø 85,50 mm

101.570 Ø 85,50 mm

101.620 Ø 85,50 mm

510.450 Connecting Rod



101.450 Connecting Rod



OEM Ref. 911 145 738 2

510.800 Crankshaft



OEM Ref.

510.820 Gear



OEM Ref. 1641625

ASEL CODE	511.100
OEM Reference	911 504 052 0 / 0762788
Kullanılan Araç Vehicle Application	ATI 3300 / 310CV / 350CV / F95 330 / 95XF



Technical Data	
Cylinder Bore	Ø 75.00 mm
Swept Volume	440 cc
Stroke	50 mm

511.200 Complete Cylinder Head



OEM Ref.

511.210 Cylinder Head



OEM Ref.

511.250 Plate



OEM Ref. 513823
911 504 500 2

511.300 Full Repair Kit



OEM Ref. 513826

511.320 Repair Kit



OEM Ref. 911 506 910 3

511.350 Repair Kit



OEM Ref.

508.150 **Crankcase**



OEM Ref.

511.400 **Valve Kit**



OEM Ref.

511.410 **Valve Kit**



OEM Ref.

507.450 **Connecting Rod**



OEM Ref. 1304884
411 144 735 2 / 411 144 731 2

507.800 **Crankshaft**



OEM Ref.

508.830 **Crankshaft Flange**



OEM Ref.

501.500 **Ø 75,00 mm** **Piston**

501.510 **Ø 75,25 mm**

501.520 **Ø 75,50 mm**



OEM Ref.

501.550 **Ø 75,00 mm** **Piston & Ring**

501.560 **Ø 75,25 mm**

501.570 **Ø 75,50 mm**



OEM Ref. 0513860 / 1242704 / 5000816053 / FBU7209
411 141 623 2 / 411 522 620 2

109.600 **Ø 75,00 mm** **Ring**

109.610 **Ø 75,25 mm**

109.620 **Ø 75,50 mm**



OEM Ref. 1391384 / 1391385
3090388 / I801770061

OEM Ref.

OEM Ref.

OEM Ref.

ASEL CODE

512.100

OEM Reference

912 518 005 0 / 1883118

**Kullanılan Araç
Vehicle Application**

XF105 / CF85 / TEMSA SAFIR / PACCAR ENGINE / EURO 6

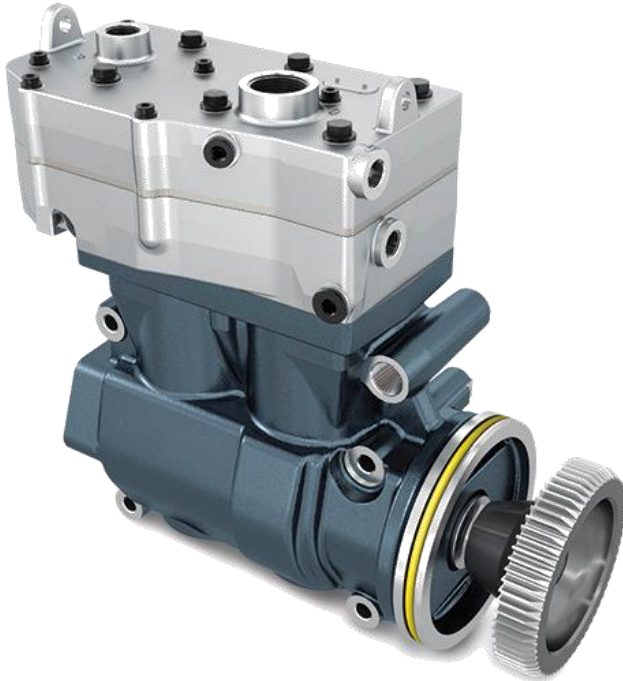

Technical Data

Cylinder Bore	Ø 85.00 mm
Swept Volume	352-119 cc
Stroke	62-21 mm

512.200

Complete Cylinder Head

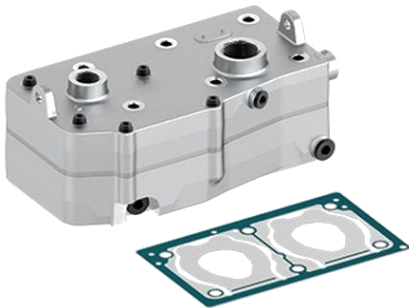

OEM Ref. 1941114
912 518 925 2

512.210

Cylinder Head



OEM Ref.

512.250

Plate

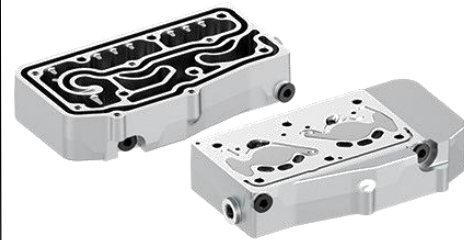

OEM Ref.

510.270

Cooling Plate



OEM Ref.

510.300

Full Repair Kit

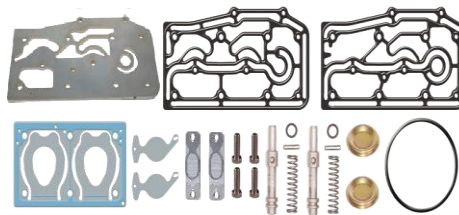

OEM Ref.

510.310

Repair Kit

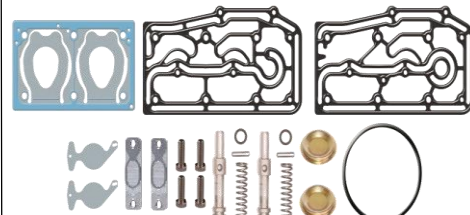

OEM Ref.

510.320 **Repair Kit**

OEM Ref.

510.350 **Gasket Kit**

OEM Ref.

512.150 **Crankcase**

OEM Ref.

102.400 **Valve Kit**

OEM Ref.

510.410 **Valve Kit**

OEM Ref.

510.760 **Adapter**

OEM Ref. 911 902 013 4

101.500 **Ø 85,00 mm** **Piston**

101.510 **Ø 85,25 mm**

101.520 **Ø 85,50 mm**

OEM Ref.

101.550 **Ø 85,00 mm** **Piston & Ring**

101.560 **Ø 85,25 mm**

101.570 **Ø 85,50 mm**

OEM Ref. 0697442 / 1698686 / 1283781 / FBU2076
000 130 34 17 / 911 501 624 2 / 911 501 625 2

101.600 **Ø 85,00 mm** **Ring**

101.610 **Ø 85,25 mm**

101.620 **Ø 85,50 mm**

OEM Ref. 3094621
911 501 920 2

510.450 **Connecting Rod**

101.450 **Connecting Rod**

OEM Ref. 911 145 738 2

510.800 **Crankshaft**

OEM Ref.

510.820 **Gear**

OEM Ref. 1641625

ASEL CODE

512.110

OEM Reference

912 518 006 0 / 1883120

**Kullanılan Araç
Vehicle Application**

XF106 / TEMSA SAFIR / PACCAR ENGINE / EURO 6

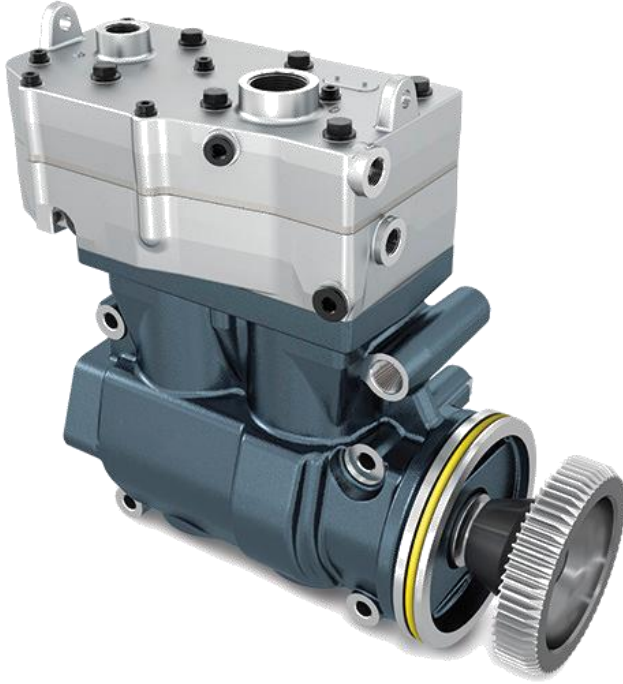

Technical Data

Cylinder Bore	Ø 85.00 mm
Swept Volume	352-119 cc
Stroke	62-21 mm

512.200

Complete Cylinder Head

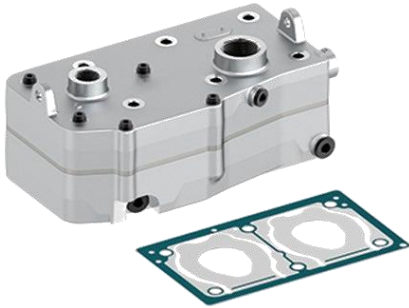

OEM Ref. 1941114
912 518 925 2

512.210

Cylinder Head



OEM Ref.

512.250

Plate

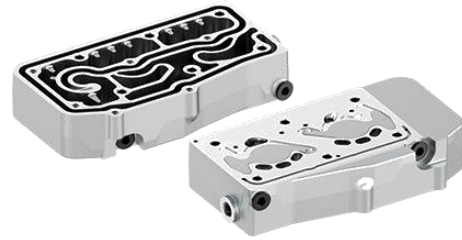

OEM Ref.

510.270

Cooling Plate



OEM Ref.

510.300

Full Repair Kit

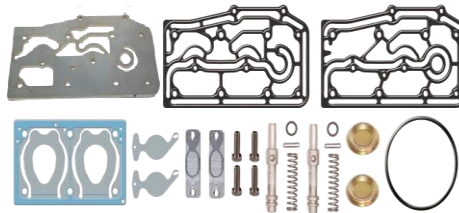

OEM Ref.

510.310

Repair Kit

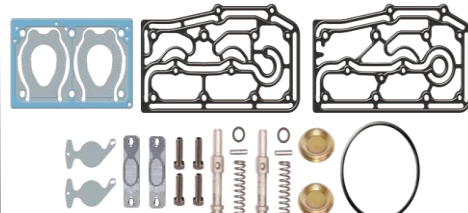

OEM Ref.

ASEL CODE**513.100****OEM Reference**

LK3839 / LK3879 / K008457000 / 1403939 / 9P920586

**Kullanılan Araç
Vehicle Application**

LF45 / LF55

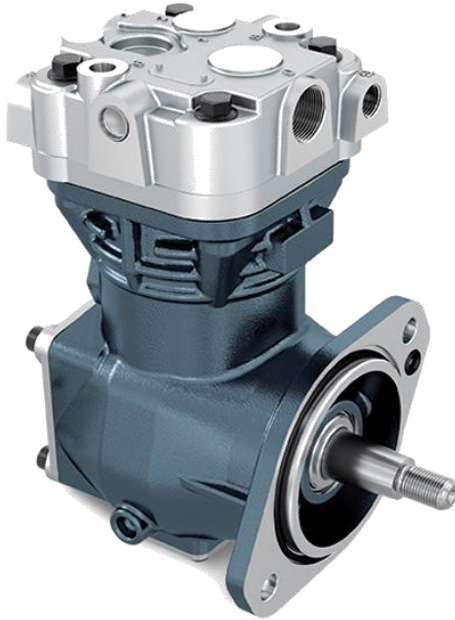
**Technical Data**

Cylinder Bore	Ø 80.00 mm
Swept Volume	225 cc
Stroke	45 mm

513.200**Complete Cylinder Head**

OEM Ref.

513.210**Cylinder Head**OEM Ref. 1439981
SEB01629004**358.250****Plate**

OEM Ref.

358.300**Full Repair Kit**

OEM Ref.

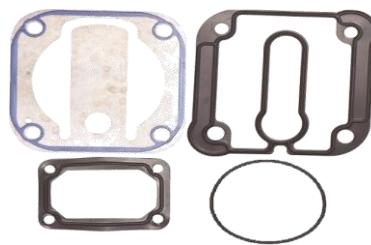
358.310**Gasket Kit**

OEM Ref. SEB018190052

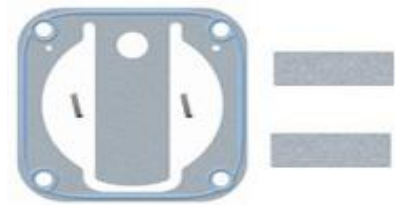
305.400**Valve Kit**

OEM Ref.



KOMPRESOR YEDEK PARÇALARI
COMPRESSOR SPARE PARTS

İÇİNDEKİLER / INDEX

Sayfa No / Page No

SCANIA

124 / 4 SERIES TRUCK / T TRUCK / 4 SERIES BUS / 340 SERIES	242-243
124 – 4 / 4 SERIES TRUCK / T TRUCK / 4 SERIES BUS	244-245
BUS 93 / 3 SERIES TRUCK / 4 SERIES TRUCK	246-247
3 SERIES TRUCK – BUS / 4 SERIES TRUCK – BUS	248
4 SERIES TRUCK	249
EURO 4 SERIES / EURO 5 / EURO 6 / G420 / G440 R SERIES / T TRUCK / BUS	250-251
3 SERIES – BUS	252-253
82 / 92 / 93 / 123 / 113 / 141	254-255
P – G – R / T TRUCK / F / K / N BUS	256-257
P – G – R / T TRUCK / F / K / N BUS	258
SCANIA P – G – R / T TRUCK / F / K / N BUS	259
4 SERIES BUS	260-261
4 SERIES BUS / F – K – N BUS / EURO 5 / EURO 6	262-263

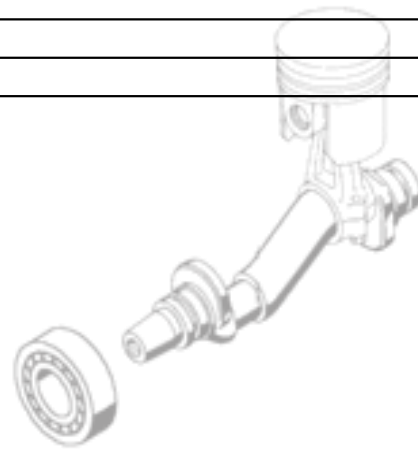
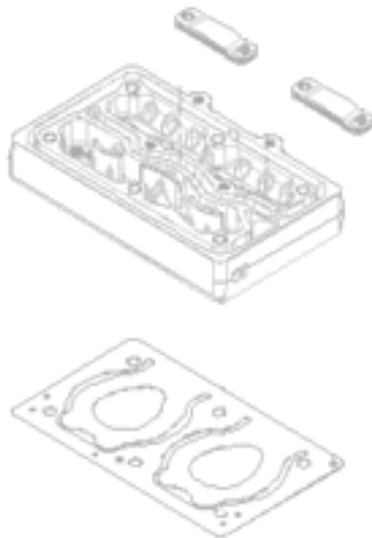

ASEL CODE

601.100

OEM Reference

LP4965 / II32688 / 1380457 / 1514064 / 1470304 / 571039 / 571287 / 1728435

**Kullanılan Araç
Vehicle Application**

124 / 4 SERIES TRUCK / T TRUCK / 4 SERIES BUS / 340 SERIES

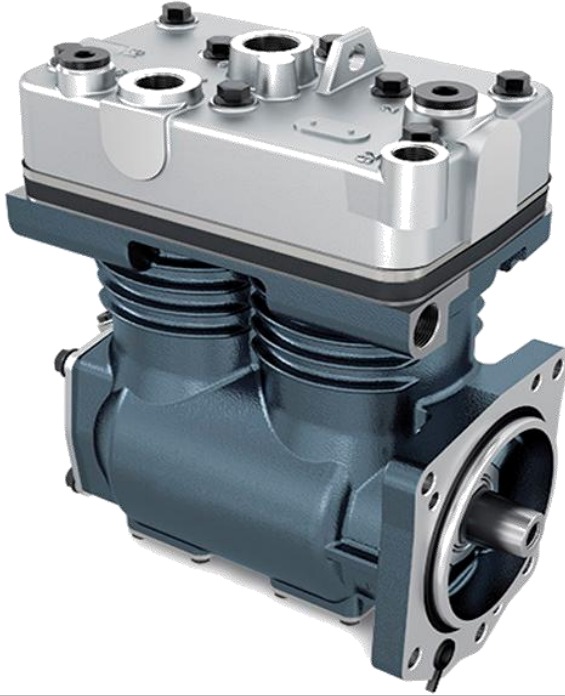

Technical Data

Cylinder Bore	Ø 88.00 mm
Swept Volume	608 cc
Stroke	50 mm

601.200

Complete Cylinder Head

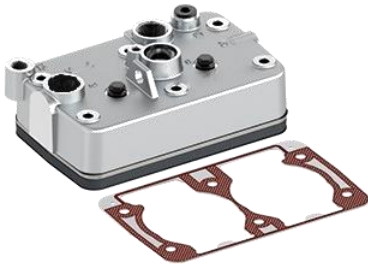

OEM Ref.

601.210

Cylinder Head



OEM Ref. 1424766
SEB01444004

405.250

Plate

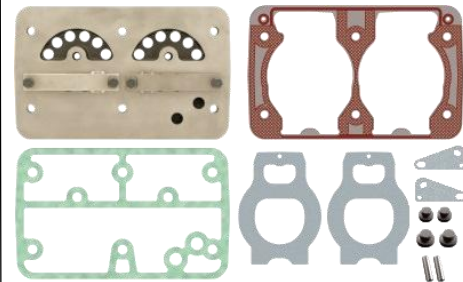

OEM Ref. 1376272
3097146 / SEB01033004

405.300

Full Repair Kit

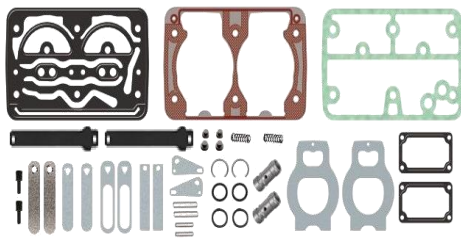

OEM Ref. 1376281 / 1376281
SEB22560

405.310

Repair Kit

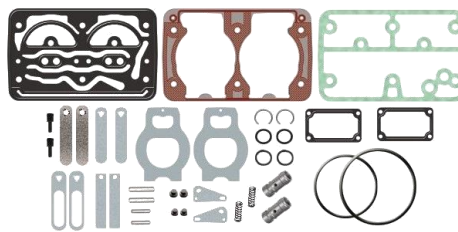

OEM Ref. SEB22596

405.320

Repair Kit

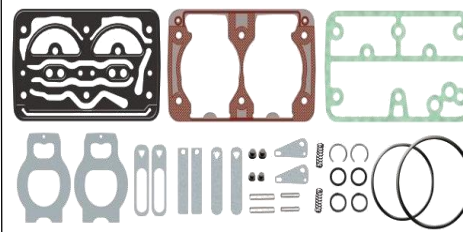

OEM Ref.

405.350 Gasket Kit

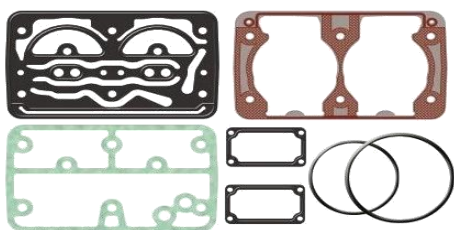

OEM Ref. 1376281 / 1542159
SEB22561

601.150 Crankcase



OEM Ref.

405.450 Connecting Rod



OEM Ref. SEB00967004

405.400 Valve Kit



OEM Ref. 3097145

405.410 Valve Kit



OEM Ref. 1376279
II159920063

214.750 Bushing



OEM Ref. 1315274

107.500 Ø 88,00 mm Piston

107.510 Ø 88,25 mm

107.520 Ø 88,50 mm



OEM Ref.

107.550 Ø 88,00 mm Piston & Ring

107.560 Ø 88,25 mm

107.570 Ø 88,50 mm



OEM Ref. 1698848 / 3095841 / 85101375
I81169004 / SEB22555

107.600 Ø 88,00 mm Ring

107.610 Ø 88,25 mm

107.620 Ø 88,50 mm



OEM Ref. II39526F0061 / I811690062

601.800 Crankshaft



OEM Ref.

601.820 Gear



OEM Ref. 1775248 / 1732078

601.830 Crankshaft Flange



OEM Ref. 1932013
K036087K50

ASEL CODE

601.110

OEM Reference

LP4964 / II32687 / K002046 / 1380455 / 1470303 / 1514063 / 571286

**Kullanılan Araç
Vehicle Application**

124-4 / 4 SERIES TRUCK / T TRUCK / 4 SERIES BUS

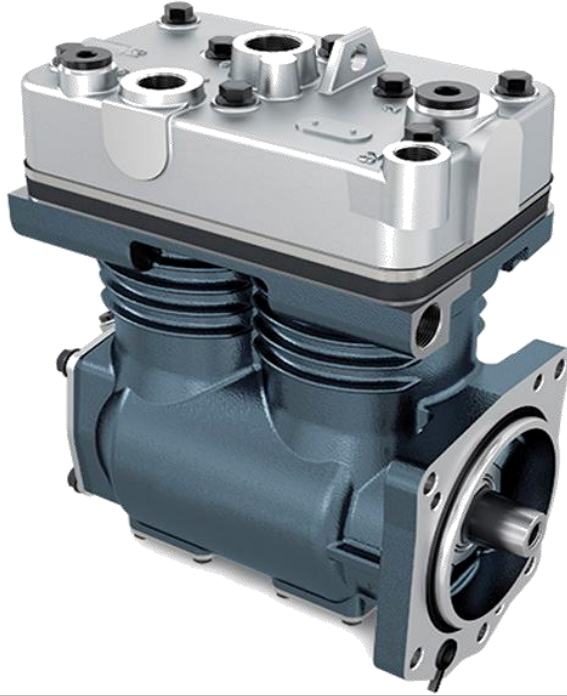

Technical Data

Cylinder Bore	Ø 88.00 mm
Swept Volume	608 cc
Stroke	50 mm

601.200

Complete Cylinder Head



OEM Ref.

601.210

Cylinder Head



OEM Ref. 1424766
SEB01444004

405.250

Plate

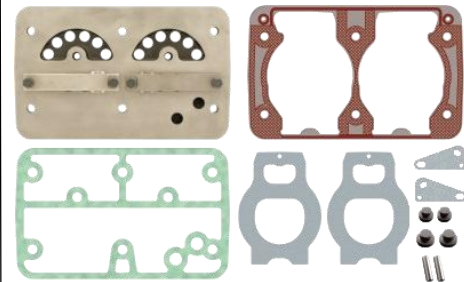

OEM Ref. 1376272
3097146 / SEB01033004

405.300

Full Repair Kit

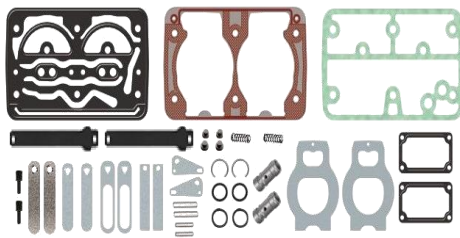

OEM Ref. 1376281 / 1376281
SEB22560

405.310

Repair Kit

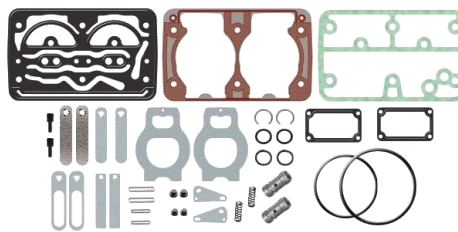

OEM Ref. SEB22596

405.320

Repair Kit

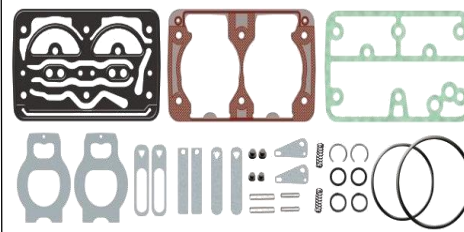

OEM Ref.

405.350 Gasket Kit

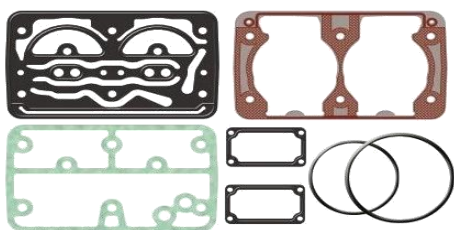

OEM Ref.1376281 / 1542159
SEB22561

601.155 Crankcase



OEM Ref.

405.450 Connecting Rod



OEM Ref. SEB00967004

405.400 Valve Kit



OEM Ref. 3097145

405.410 Valve Kit



OEM Ref. 1376279
II159920063

405.160 Cover



OEM Ref.

107.500 Ø 88,00 mm Piston

107.510 Ø 88,25 mm

107.520 Ø 88,50 mm



OEM Ref.

107.550 Ø 88,00 mm Piston & Ring

107.560 Ø 88,25 mm

107.570 Ø 88,50 mm



OEM Ref. 1698848 / 3095841 / 85101375
I81169004 / SEB22555

107.600 Ø 88,00 mm Ring

107.610 Ø 88,25 mm

107.620 Ø 88,50 mm



OEM Ref. II39526F0061 / I811690062

601.805 Crankshaft



OEM Ref.

601.820 Gear



OEM Ref. 1775248 / 1732078

405.830 Crankshaft Flange



OEM Ref. 1376275
SEB013090065

ASEL CODE

602.100

OEM Reference

LP4815 / I97493000 / 571184 / 1303227

**Kullanılan Araç
Vehicle Application**

BUS 93 / 3 SERIES TRUCK / 4 SERIES TRUCK



Technical Data

Cylinder Bore	Ø 75.00 mm
Swept Volume	440 cc
Stroke	50 mm

602.200

Complete Cylinder Head



OEM Ref.

602.210

Cylinder Head



OEM Ref. 1315299
SEB22587

415.250

Plate

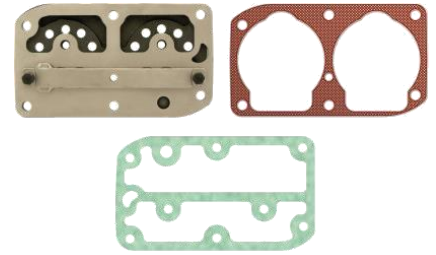

OEM Ref. 1697770 / 1697290
I81015004

415.300

Full Repair Kit

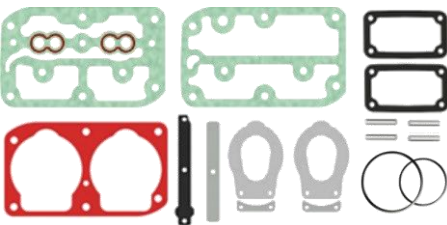

OEM Ref.

415.310

Repair Kit

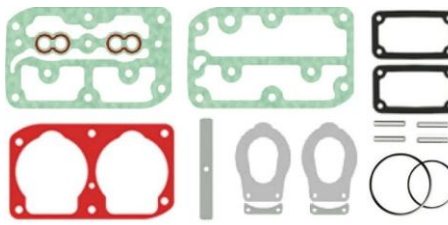

OEM Ref. SEB22541

415.320

Repair Kit

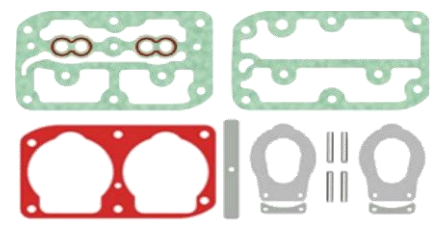

OEM Ref.

415.350 **Gasket Kit**

OEM Ref. SEB22542

415.270 **Cooling Plate**

OEM Ref.

415.150 **Crankcase**

OEM Ref.

415.400 **Valve Kit**

OEM Ref.

119.170 **Nut**

OEM Ref. 1698672 / 0698060 / 11712509
004 990 32 51 / 810 341 001 4

408.450 **Connecting Rod**

OEM Ref. 1315278 / 1697281 / 1698528 / 3090386
SEB00626004 / SEB00957004

109.500 **Ø 75,00 mm** **Piston**

109.510 **Ø 75,25 mm**

109.520 **Ø 75,50 mm**

OEM Ref.

109.550 **Ø 75,00 mm** **Piston & Ring**

109.560 **Ø 75,25 mm**

109.570 **Ø 75,50 mm**

OEM Ref. SEB22539 / SEB22540

109.600 **Ø 75,00 mm** **Ring**

109.610 **Ø 75,25 mm**

109.620 **Ø 75,50 mm**

OEM Ref. 3090388 / I801770061

405.750 **Bushing**

OEM Ref. 1315274

408.800 **Crankshaft Flange**

OEM Ref. 1697285
EB007622V

408.830 **Gear**

OEM Ref. 3090385 / 1697769
SEB00387004

ASEL CODE

602.110

OEM Reference

LP4814 / I97492 / 1303226 / 571183

**Kullanılan Araç
Vehicle Application**

3 SERIES TRUCK – BUS / 4 SERIES TRUCK - BUS



Technical Data

Cylinder Bore	Ø 75.00 mm
Swept Volume	440 cc
Stroke	50 mm

602.200

Complete Cylinder Head



OEM Ref.

602.210

Cylinder Head



OEM Ref. 1315299
SEB22587

415.250

Plate

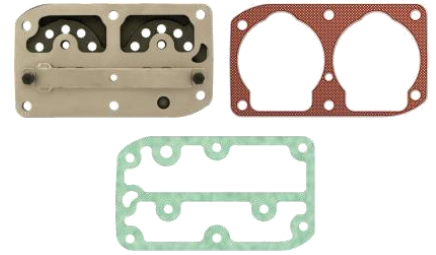

OEM Ref. 1697770 / 1697290
I81015004

415.270

Cooling Plate

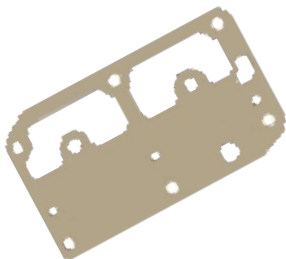

OEM Ref.

415.310

Repair Kit

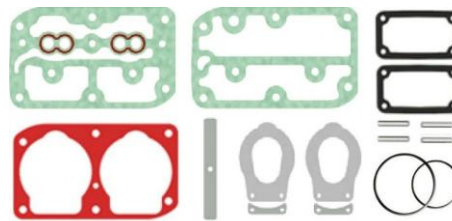

OEM Ref. SEB22541

415.170

Crankcase



OEM Ref.

ASEL CODE

603.100

OEM Reference

LK3972 / I134848 / 1390008

**Kullanılan Araç
Vehicle Application**

4 SERIES TRUCK

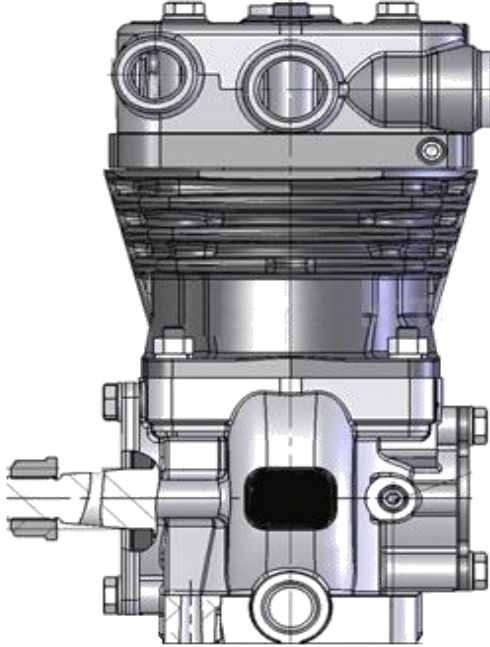

Technical Data

Cylinder Bore	Ø 88.00 mm
Swept Volume	300 cc
Stroke	50 mm

603.200

Complete Cylinder Head



OEM Ref. K021494K50 / I943140051
1698851

603.210

Cylinder Head



OEM Ref.

218.250

Plate

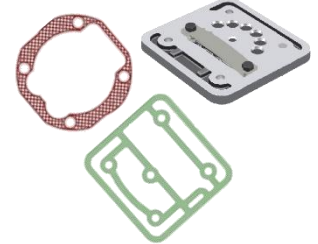

OEM Ref. I94056004

218.270

Full Repair Kit

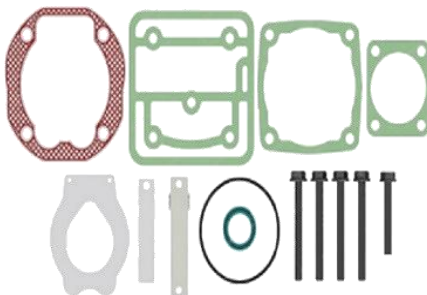

OEM Ref.

219.310

Cylinder Liner Set



OEM Ref. I808640061

107.550

Ø 88,00 mm Piston&Ring

107.560

Ø 88,25 mm

107.570

Ø 88,50 mm



OEM Ref. I81169004 / SEB22555

ASEL CODE

604.100

OEM Reference

LK4951 / K053740N05 / K053740N00 / 2024413 / 2792820 / 570972

**Kullanılan Araç
Vehicle Application**

EURO 4 SERIES / EURO 5 / EURO 6 / G420 / G440 / R SERIES / T TRUCK / BUS

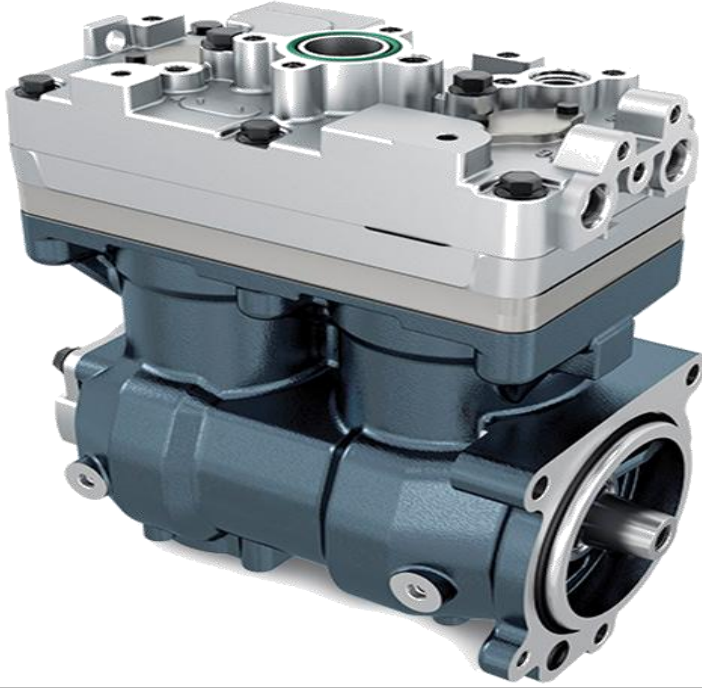

Technical Data

Cylinder Bore	Ø 86.00 mm
Swept Volume	720 cc
Stroke	62 mm

604.200

Complete Cylinder Head

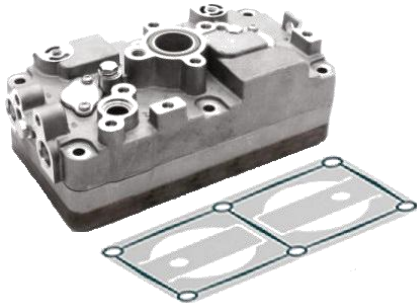

OEM Ref.

604.210

Cylinder Head

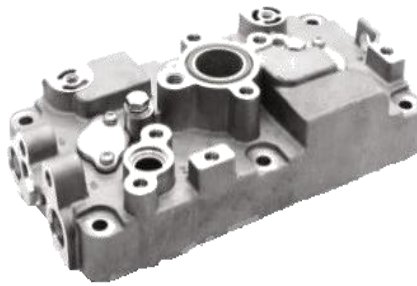

OEM Ref. K018810

604.250

Plate

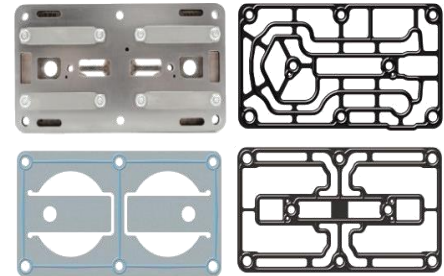

OEM Ref. K018806

604.270

Cooling Plate



OEM Ref.

604.300

Full Repair Kit

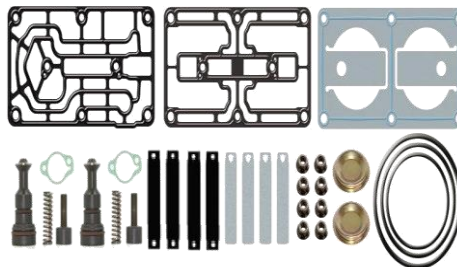

OEM Ref.

604.310

Repair Kit

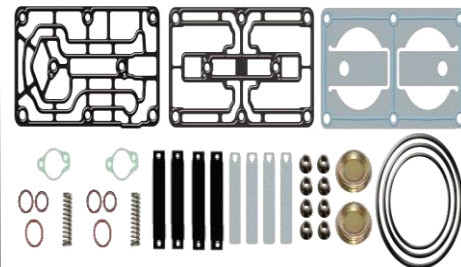

OEM Ref.

604.320 Repair Kit

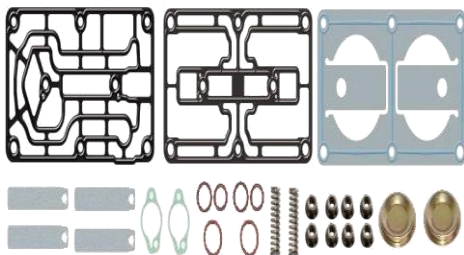

OEM Ref. 1864986 / K018809

604.330 Repair Kit

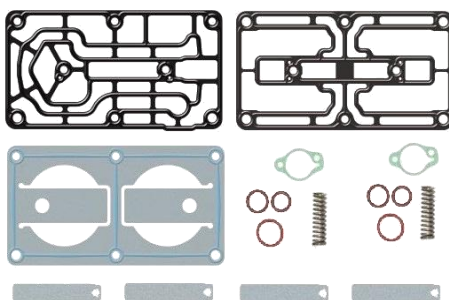

OEM Ref.

604.350 Gasket Kit

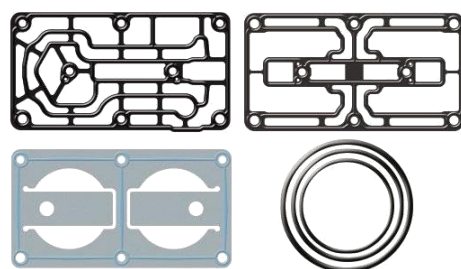

OEM Ref.

124.400 Valve Kit



OEM Ref.

124.410

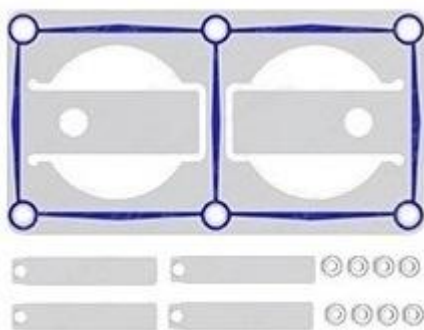

OEM Ref. 1919356
K034874K50

604.150 Crankcase



OEM Ref.

124.500 Ø 86,00 mm Piston



OEM Ref.

124.550 Ø 86,00 mm Piston & Ring



OEM Ref. 42549147
SEB22547 / SEB22548

124.600 Ø 86,00 mm Ring



OEM Ref. I139526F0061 / I811690062

124.510 Ø 86,25 mm

124.560 Ø 86,25 mm

124.610 Ø 86,25 mm

124.520 Ø 86,50 mm

124.570 Ø 86,50 mm

124.620 Ø 86,50 mm

604.450 Connecting Rod



OEM Ref.

604.800 Crankshaft



OEM Ref.

604.830 Crankshaft Flange



OEM Ref.

ASEL CODE

605.100

OEM Reference

KZ642 – 2RM / 1189106 / 1348919 / 300162 / 571185

**Kullanılan Araç
Vehicle Application**

3 SERIES TRUCK – BUS

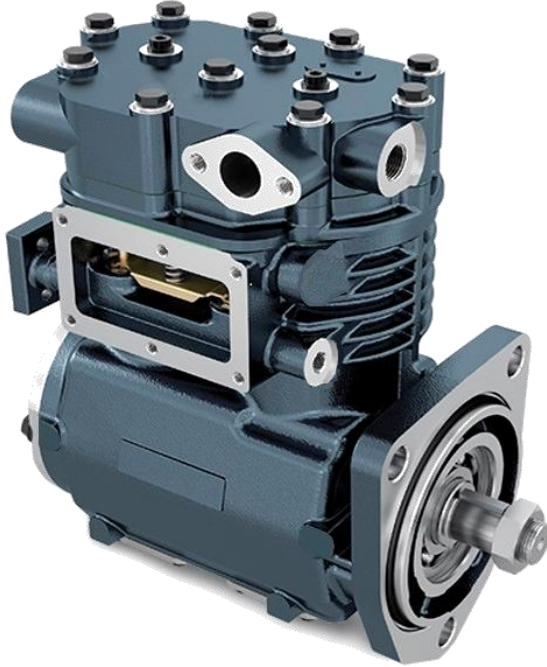

Technical Data

Cylinder Bore	Ø 75.00 mm
Swept Volume	440 cc
Stroke	50 mm

605.200

Complete Cylinder Head

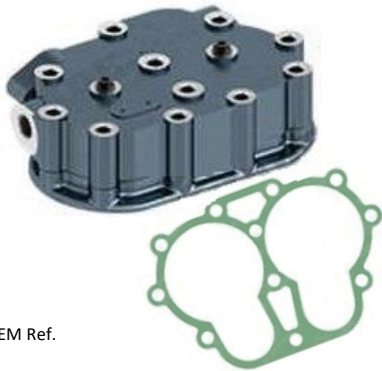

OEM Ref.

605.210

Cylinder Head

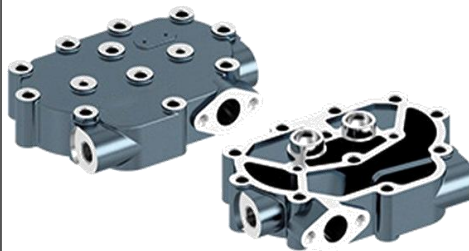

OEM Ref.

605.250

Plate



OEM Ref. 280694 / 1322813 / 3090473

407.300

Full Repair Kit

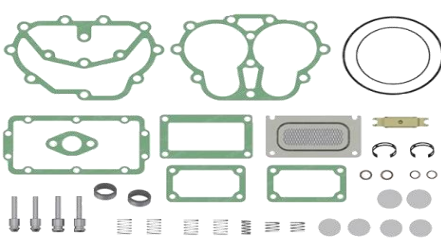

OEM Ref.

407.310

Repair Kit

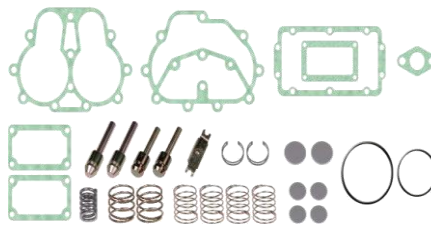

OEM Ref.

407.320

Repair Kit

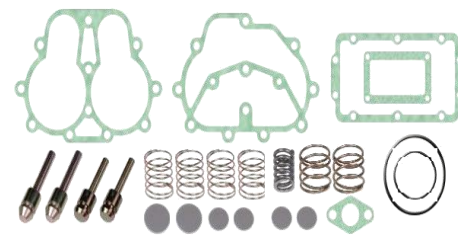

OEM Ref.

407.350 **Gasket Kit**

OEM Ref.

605.150 **Crankcase**

OEM Ref.

407.160 **Cover**

OEM Ref.

407.165 **Cover**

OEM Ref.

407.400 **Valve Kit**

OEM Ref.

407.450 **Connecting Rod**

OEM Ref. 3090257

407.500 **Ø 75,00 mm** **Piston**

407.510 **Ø 75,25 mm**

407.520 **Ø 75,50 mm**

OEM Ref. 1697706
1189256

407.550 **Ø 75,00 mm** **Piston & Ring**

407.560 **Ø 75,25 mm**

407.570 **Ø 75,50 mm**

OEM Ref. 1518358 / 3094151
1189082

407.600 **Ø 75,00 mm** **Ring**

407.610 **Ø 75,25 mm**

407.620 **Ø 75,50 mm**

OEM Ref. 3090257 / 3094155

407.800 **Crankcase**

OEM Ref.

407.830 **Crankshaft Flange**

OEM Ref. 3090239 / 1322816

407.820 **Gear**

OEM Ref. 423087

ASEL CODE

606.100

OEM Reference

KZ996 – 2RM / 1189107 / 1314107 / 1348920 / 301525 / 571186

**Kullanılan Araç
Vehicle Application**

82 / 92 / 93 / 123 / 113 / 141

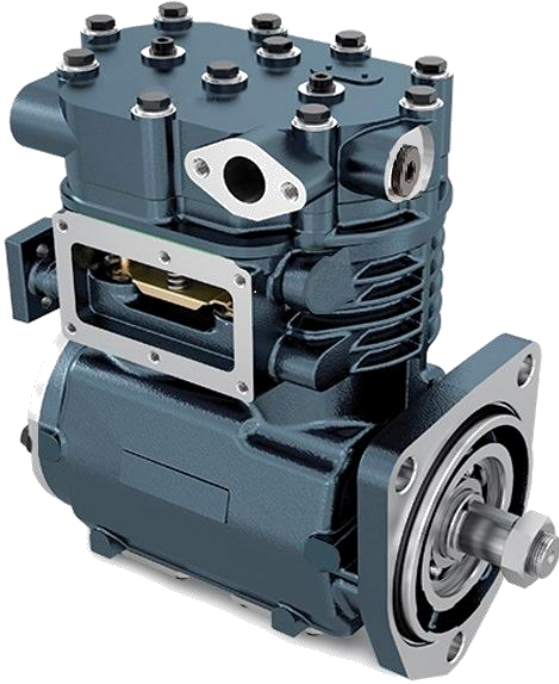

Technical Data

Cylinder Bore	Ø 75.00 mm
Swept Volume	440 cc
Stroke	50 mm

606.200

Complete Cylinder Head

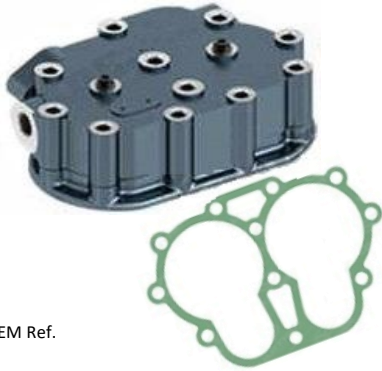

OEM Ref.

606.210

Cylinder Head

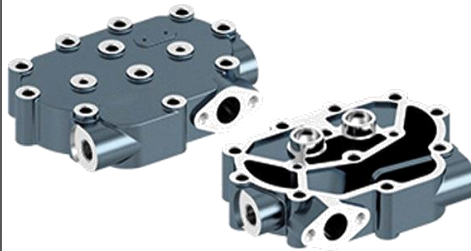

OEM Ref.

605.250

Plate



OEM Ref. 280694 / 1322813 / 3090473

407.300

Full Repair Kit

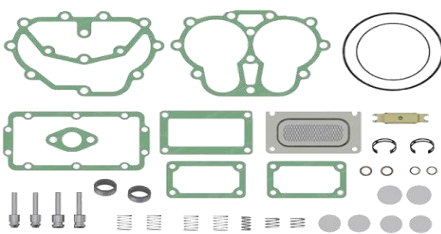

OEM Ref.

407.310

Repair Kit

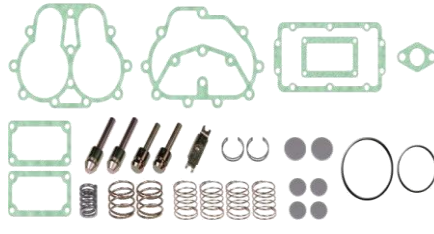

OEM Ref.

407.320

Repair Kit

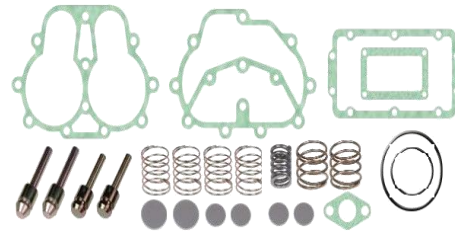

OEM Ref.

407.350 **Gasket Kit**

OEM Ref.

606.150 **Crankcase**

OEM Ref.

407.160 **Cover**

OEM Ref.

407.165 **Cover**

OEM Ref.

407.400 **Valve Kit**

OEM Ref.

407.450 **Connecting Rod**

OEM Ref. 3090257

407.500 **Ø 75,00 mm** **Piston**

407.510 **Ø 75,25 mm**

407.520 **Ø 75,50 mm**

OEM Ref. 1697706
1189256

407.550 **Ø 75,00 mm** **Piston & Ring**

407.560 **Ø 75,25 mm**

407.570 **Ø 75,50 mm**

OEM Ref. 1518358 / 3094151
1189082

407.600 **Ø 75,00 mm** **Ring**

407.610 **Ø 75,25 mm**

407.620 **Ø 75,50 mm**

OEM Ref. 3090257 / 3094155

407.800 **Crankcase**

OEM Ref.

407.830 **Crankshaft Flange**

OEM Ref. 3090239 / 1322816

407.820 **Gear**

OEM Ref. 423087

ASEL CODE

607.100

OEM Reference

LK4949 / K009580S / K009580000 / 2024410 / 1882222 / 1901246

**Kullanılan Araç
Vehicle Application**

P – G – R / T TRUCK – F / K / N BUS

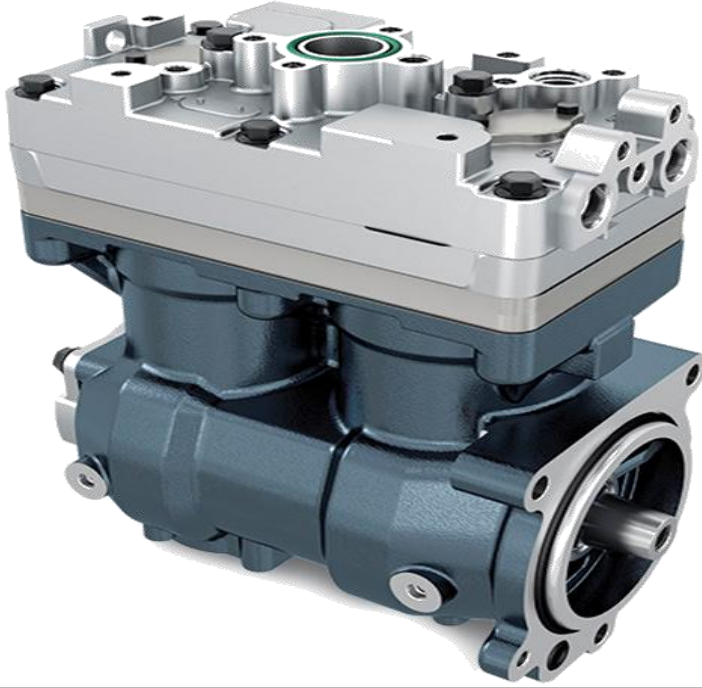

Technical Data

Cylinder Bore	Ø 86.00 mm
Swept Volume	720 cc
Stroke	62 mm

604.200

Complete Cylinder Head

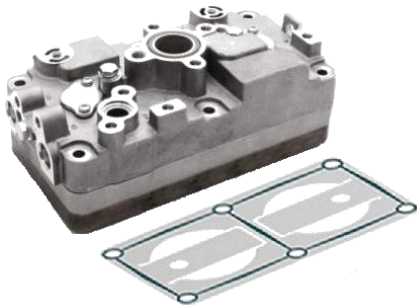

OEM Ref.

604.210

Cylinder Head

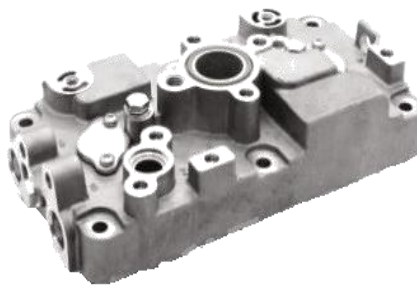

OEM Ref. K018810

604.250

Plate

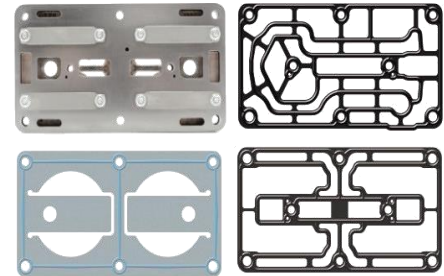

OEM Ref. K018806

604.270

Cooling Plate



OEM Ref.

604.300

Full Repair Kit

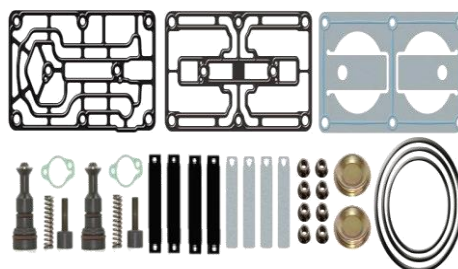

OEM Ref.

604.310

Repair Kit

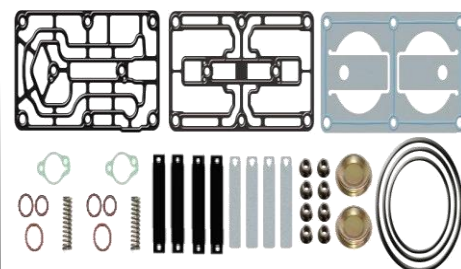

OEM Ref.

604.320 **Repair Kit**

OEM Ref. 1864986 / K018809

604.330 **Repair Kit**

OEM Ref.

604.350 **Gasket Kit**

OEM Ref.

124.400 **Valve Kit**

OEM Ref.

124.410

OEM Ref. 1919356
K034874K50

607.150 **Crankcase**

OEM Ref.

124.500 **Ø 86,00 mm** **Piston**

124.510 **Ø 86,25 mm**

124.520 **Ø 86,50 mm**

OEM Ref.

124.550 **Ø 86,00 mm** **Piston & Ring**

124.560 **Ø 86,25 mm**

124.570 **Ø 86,50 mm**

OEM Ref. 42549147
SEB22547 / SEB22548

124.600 **Ø 86,00 mm** **Ring**

124.610 **Ø 86,25 mm**

124.620 **Ø 86,50 mm**

OEM Ref. I139526F0061 / I811690062

604.450 **Connecting Rod**

OEM Ref.

607.800 **Crankshaft**

OEM Ref.

607.830 **Crankshaft Flange**

OEM Ref.

ASEL CODE**607.110****OEM Reference**

LK4961 / K018625000 / K009580000

**Kullanılan Araç
Vehicle Application**

P – G – R / T TRUCK – F / K / N BUS

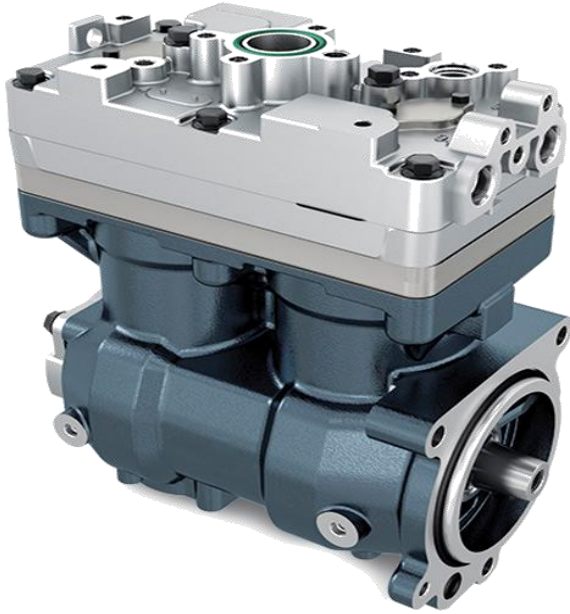
**Technical Data**

Cylinder Bore	Ø 86.00 mm
Swept Volume	720 cc
Stroke	62 mm

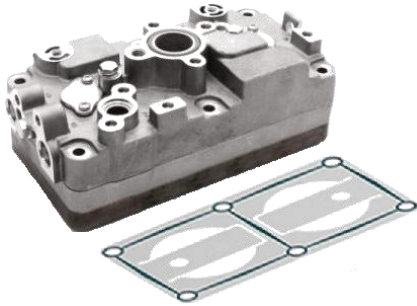
604.200**Complete Cylinder Head**

OEM Ref.

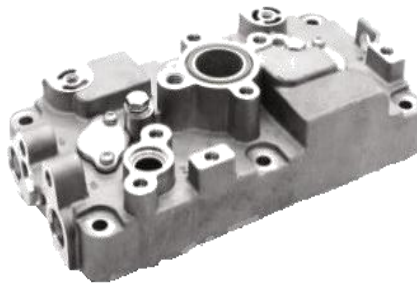
604.210**Cylinder Head**

OEM Ref. K018810

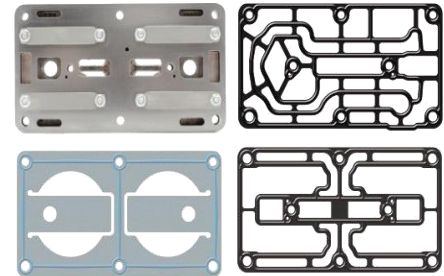
604.250**Plate**

OEM Ref. K018806

604.270**Cooling Plate**

OEM Ref.

607.825**Gear**

OEM Ref. 2022259

607.805**Crankshaft**

OEM Ref.

ASEL CODE**607.120****OEM Reference**

LK4970 / K038653N00 / K181219N00 / 1918307

**Kullanılan Araç
Vehicle Application**

SCANIA P – G – R / T TRUCK – F / K / N BUS

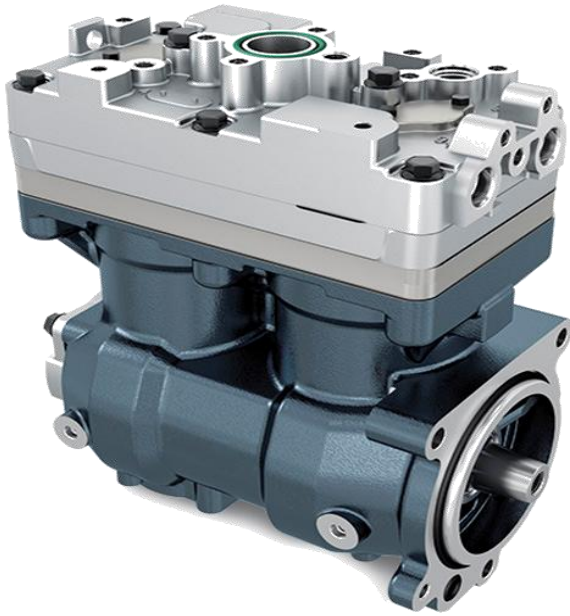
**Technical Data**

Cylinder Bore	Ø 86.00 mm
Swept Volume	720 cc
Stroke	62 mm

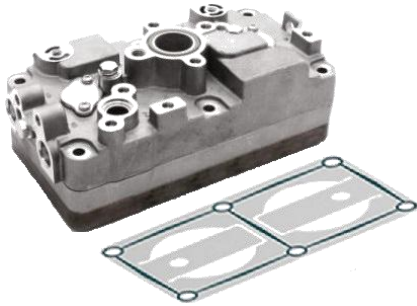
604.200**Complete Cylinder Head**

OEM Ref.

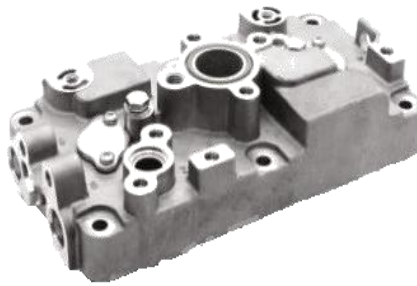
604.210**Cylinder Head**

OEM Ref. K018810

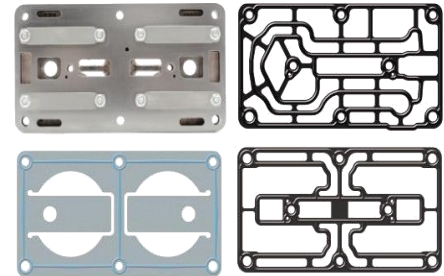
604.250**Plate**

OEM Ref. K018806

604.450**Connecting Rod**

OEM Ref.

607.805**Crankshaft**

OEM Ref.

607.830**Crankshaft Flange**

OEM Ref.

ASEL CODE

608.100

OEM Reference

LK4930 / 1537794 / 1745702 / 2032484 / 571197

**Kullanılan Araç
Vehicle Application**

4 SERIES BUS

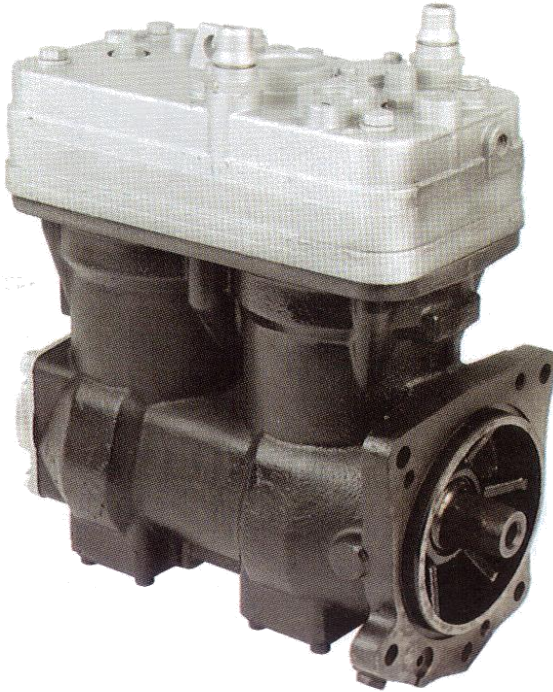

Technical Data

Cylinder Bore	Ø 92.00 mm
Swept Volume	720 cc
Stroke	62 mm

608.200

Complete Cylinder Head



OEM Ref.

608.210

Cylinder Head



OEM Ref. K017529

417.250

Plate

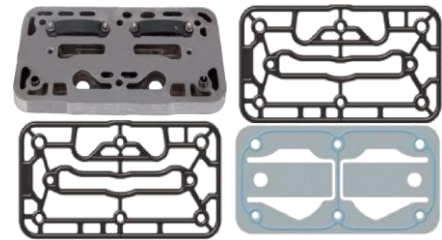

OEM Ref. 21136726 / K012074 / K099412K50

417.270

Cooling Plate



OEM Ref.

417.300

Full Repair Kit

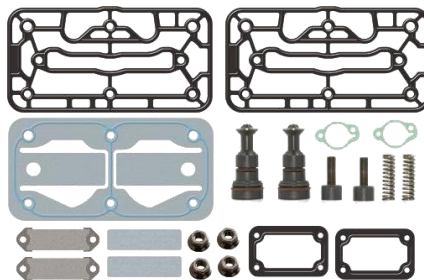

OEM Ref.

417.310

Repair Kit

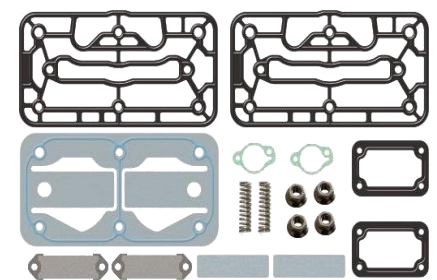

OEM Ref. K012086

417.320 **Repair Kit**

OEM Ref.

417.350 **Gasket Kit**

OEM Ref.

608.150 **Crankcase**

OEM Ref.

124.400 **Valve Kit**

OEM Ref.

417.400 **Valve Kit**

OEM Ref.

224.450 **Connecting Rod**

OEM Ref.

214.500 **Ø 92,00 mm** **Piston**

214.510 **Ø 92,25 mm**

214.520 **Ø 92,50 mm**

OEM Ref.

214.550 **Ø 92,00 mm** **Piston & Ring**

214.560 **Ø 92,25 mm**

214.570 **Ø 92,50 mm**

OEM Ref. K006026 /K012079 /K012079K56 /K012079K57
SEB22530 / 51.54119-6008 /51.54119-6009 /7421136690

214.600 **Ø 92,00 mm** **Ring**

214.610 **Ø 92,25 mm**

214.620 **Ø 92,50 mm**

OEM Ref.

405.750 **Bushing**

OEM Ref. 1315274

608.800 **Crankshaft**

OEM Ref.

608.830 **Crankshaft Flange**

OEM Ref.

ASEL CODE

609.100

OEM Reference

912 522 000 0 / 912 522 001 0 / 912 522 002 0 / 2573753 / 2039907 / 2039906

**Kullanılan Araç
Vehicle Application**

4 SERIES BUS / F – K – N BUS / EURO 5 / EURO 6



Technical Data

Cylinder Bore	Ø 85.00 mm
Swept Volume	636 cc
Stroke	56 mm

609.200

Complete Cylinder Head



OEM Ref.

609.210

Cylinder Head



OEM Ref.

609.250

Plate



OEM Ref.

609.270

Cooling Plate



OEM Ref.

609.300

Full Repair Kit

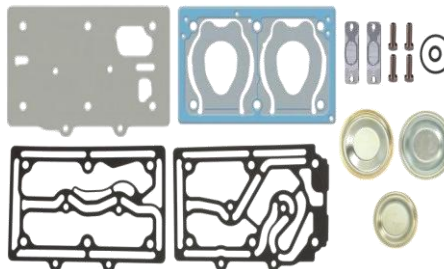

OEM Ref.

609.310

Repair Kit

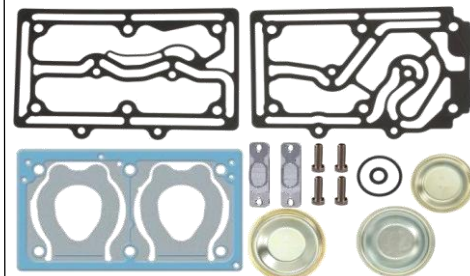

OEM Ref.

609.320 Repair Kit

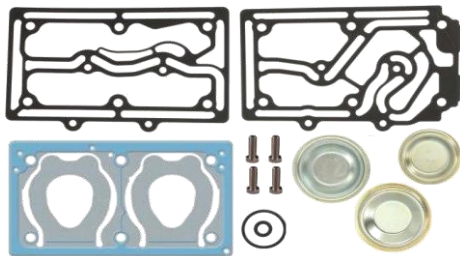

OEM Ref.

609.350 Gasket Kit

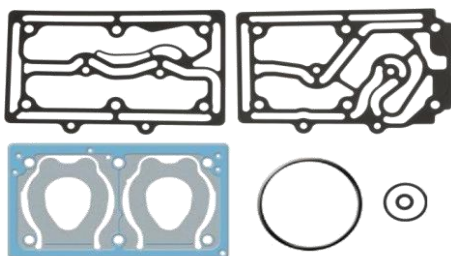

OEM Ref.

OEM Ref.

101.500 Ø 85,00 mm Piston

101.510 Ø 85,25 mm

101.520 Ø 85,50 mm



OEM Ref.

101.550 Ø 85,00 mm Piston & Ring

101.560 Ø 85,25 mm

101.570 Ø 85,50 mm



OEM Ref. 0697442 / 1698686 / 1283781 / FBU2076
000 130 34 17 / 911 501 624 2 / 911 501 625 2

101.600 Ø 85,00 mm Ring

101.610 Ø 85,25 mm

101.620 Ø 85,50 mm





RENAULT

KOMPRESOR YEDEK PARÇALARI
COMPRESSOR SPARE PARTS

www.aseltr.com

İÇİNDEKİLER / INDEX

Sayfa No / Page No

RENAULT

RVI / MAJOR / PREMIUM / KERAX / MAGNUM RVI / 270 / 380 / 400 / 420 / 440 / 460 SISU	264 - 265
G220 - 260 - 270 - 290 / R310 - 330 - 340 - 365	266 - 267
GF SERIES / JP SERIES / S SERIES	268
MAJOR / R SERIES	269
PREMIUM / KERAX / SISU / PUNCHER	270
PREMIUM 420 MAGNUM 390 / 430 / 470 / E-TECH 400 / 440 / 480 KERAX / SISU	271
MAGNUM DXI	272 - 273
MAGNUM DXI12 / DXI13 / 430 / 440 / PREMIUM 420 / 440 / 450	
KERAX 440 / 450 MAGNUM EUROTECH 440 / 420	274 - 275
RENAULT 480	276 - 277
FH16 / FM9 / FH16II	278 - 279
RENAULT 420 / PREMIUM TRACTEUR / KERAX / PREMIUM PR 4X2	280 - 281
C EURO 6 / D EURO 6	282 - 283
T EURO 6 / K EURO 6 / C EURO 6	284
RENAULT PREMIUM / TRACTEUR KERAX / PR 4X2 MAGNUM E-TECH 400 / 440 / 480	285

ASEL CODE**701.100****OEM Reference**

LP4845 / SEB01455000 / 5000694824 / 5001836982 / 5010295545 / 5010323738

**Kullanılan Araç
Vehicle Application**

RVI / MAJOR / PREMIUM / KERAX / MAGNUM RVI / 270 / 380 / 400 / 420 / 440 / 460 SISU

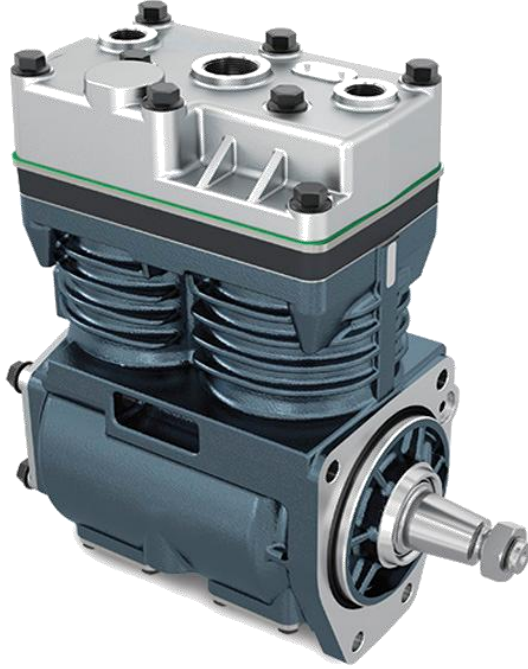
**Technical Data**

Cylinder Bore	Ø 78.00 mm
Swept Volume	500 cc
Stroke	52 mm

701.200**Complete Cylinder Head**

OEM Ref.

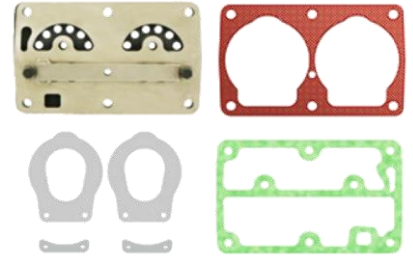
701.210**Cylinder Head**OEM Ref. SEB22583 / SEB22584 / SEB22585 / SEB22586
5001867712 / 5001867710**701.250****Plate**OEM Ref. SEB01511004 / SEB01495004
5001836883**701.270****Cooling Plate**

OEM Ref.

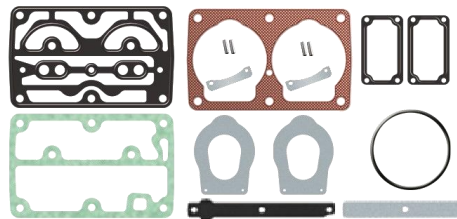
701.300**Full Repair Kit**

OEM Ref.

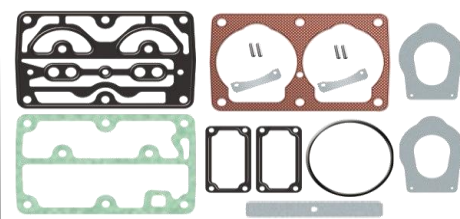
701.310**Repair Kit**OEM Ref. SEB22553
5001867708 / 5001867709 / 5001850968

701.320 Repair Kit

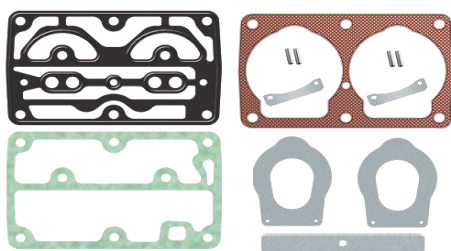

OEM Ref.

701.350 Gasket Kit

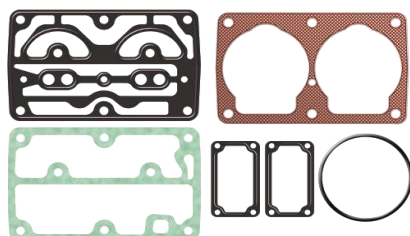

OEM Ref. SEB22554

701.150 Crankcase



OEM Ref.

415.400 Valve Kit



OEM Ref. II326840061

405.160 Cover



OEM Ref.

701.450 Connecting Rod



OEM Ref. SEB00859R
5001830854

701.500 Ø 78,00 mm Piston

701.510 Ø 78,25 mm

701.520 Ø 78,50 mm



OEM Ref.

701.550 Ø 78,00 mm Piston & Ring

701.560 Ø 78,25 mm

701.570 Ø 78,50 mm



OEM Ref. SEB22551 / SEB22552
5001830855 / 5001831273

701.600 Ø 78,00 mm Ring

701.610 Ø 78,25 mm

701.620 Ø 78,50 mm



OEM Ref.

701.800 Crankshaft



OEM Ref. EB014931R
5001834292

701.820 Gear



OEM Ref. 5000686842

701.830 Crankshaft Flange



OEM Ref. EB01490R
5001830851

ASEL CODE

702.100

OEM Reference

LP4943 / SEB01158000 / 5000694446 / 5000670603 / 7485000000

**Kullanılan Araç
Vehicle Application**

G220 - 260 - 270 - 290 / R310 - 330 - 340 - 365



Technical Data

Cylinder Bore	Ø 65.00 mm
Swept Volume	330 cc
Stroke	50 mm

702.200

Complete Cylinder Head



OEM Ref.

702.210

Cylinder Head



OEM Ref. SEB22591
5001867699

702.250

Plate

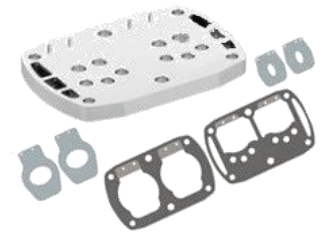

OEM Ref.

702.300

Full Repair Kit

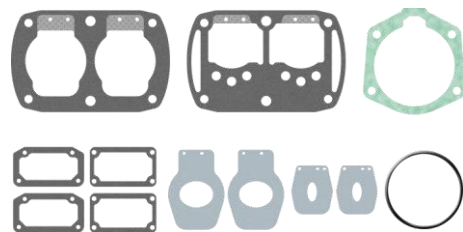

OEM Ref. SEB22526 / SEB22535
5001867696 / 5001867703

702.310

Repair Kit

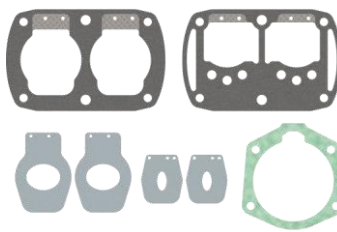

OEM Ref.

702.350

Gasket Kit

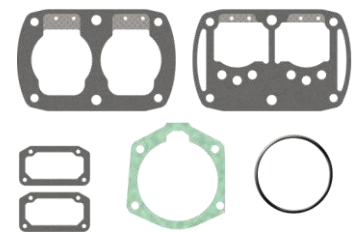

OEM Ref. SEB22536

702.150

Crankcase



OEM Ref.

702.160

Cover

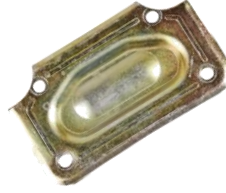

OEM Ref.

702.450

Valve Kit



OEM Ref.

702.450

Connecting Rod



OEM Ref.

702.800

Crankshaft



OEM Ref. 5001830846

702.830

Crankshaft Flange



OEM Ref. SEB00351
5000814152

702.500

Ø 65,00 mm

Piston

702.510

Ø 65,25 mm

702.520

Ø 65,50 mm



OEM Ref.

702.550

Ø 65,00 mm

Piston & Ring

702.560

Ø 65,25 mm

702.570

Ø 65,50 mm



OEM Ref. 5001823287 / 5001823288
76618501 / 76618601

702.600

Ø 65,00 mm

Ring

702.610

Ø 65,25 mm

702.620

Ø 65,50 mm



OEM Ref.

OEM Ref.

OEM Ref.

OEM Ref.

ASEL CODE	703.100
OEM Reference	LP1573 / I75543 / 5000612500
Kullanılan Araç Vehicle Application	GF SERIES / JP SERIES / S SERIES



Technical Data	
Cylinder Bore	Ø 75.00 mm
Swept Volume	155 cc
Stroke	35 mm

109.200 Complete Cylinder Head



OEM Ref. STW63841

109.210 Cylinder Head



OEM Ref. 5000559861 / I138602F004

109.250 Plate



OEM Ref. 5001000310 / I80408 - 004 / I138717F004

109.300 Full Repair Kit



OEM Ref. SEB22161 / 5000824091

109.320 Repair Kit



OEM Ref.

109.350 Gasket Kit



OEM Ref.

ASEL CODE**704.100****OEM Reference**

5000793615

**Kullanılan Araç
Vehicle Application**

MAJOR / R SERIES

**Technical Data**

Cylinder Bore	Ø 100.00 mm
Swept Volume	360 cc
Stroke	35 mm

704.300**Full Repair Kit**

OEM Ref.

704.400**Valve Kit**

OEM Ref.

704.700**Cylinder Liner Kit**

OEM Ref.

704.720**Cylinder Liner**

OEM Ref.

704.500**Ø 100,00 mm****Piston**

OEM Ref.

704.600**Ø 100,00 mm****Ring**

OEM Ref.

ASEL CODE**705.100****OEM Reference**

LP4855 / SEB01747000 / 5010450646 / 5010553129 / 7485003207

**Kullanılan Araç
Vehicle Application**

PREMIUM / KERAX / SISU / PUNCHER

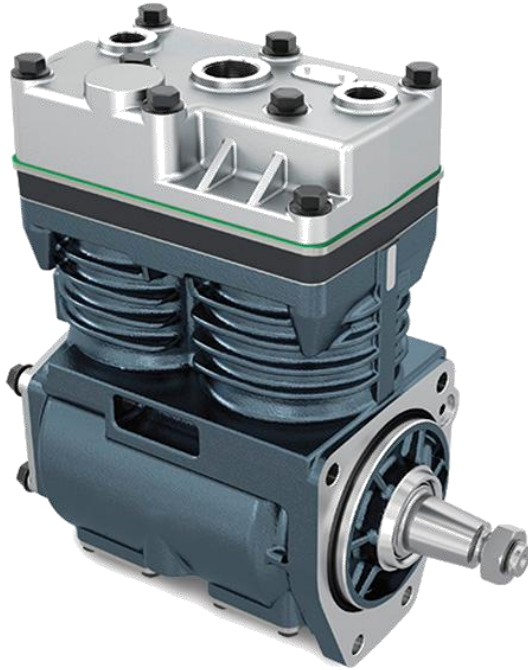
**Technical Data**

Cylinder Bore	Ø 78.00 mm
Swept Volume	500 cc
Stroke	52 mm

705.200**Complete Cylinder Head**

OEM Ref.

705.210**Cylinder Head**

OEM Ref. SEB22584

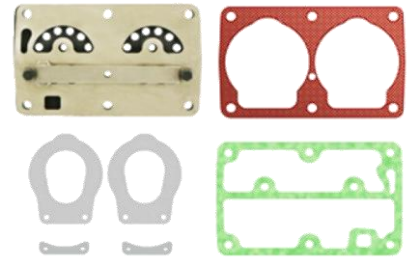
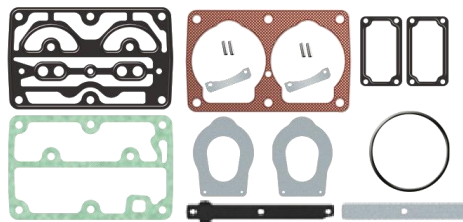
701.250**Plate**OEM Ref. SEB01511004 / SEB01495004
5001836883**701.300****Full Repair Kit**

OEM Ref.

701.450**Connecting Rod**OEM Ref. SEB00859R
5001830854**701.150****Crankcase**

OEM Ref.

ASEL CODE**706.100****OEM Reference**

LP4851 / SEB01545000 / 5010339859 / 7485003211

**Kullanılan Araç
Vehicle Application**

PREMIUM 420 MAGNUM 390 / 430 / 470 / E-TECH 400 / 440 / 480 KERAX / SISU

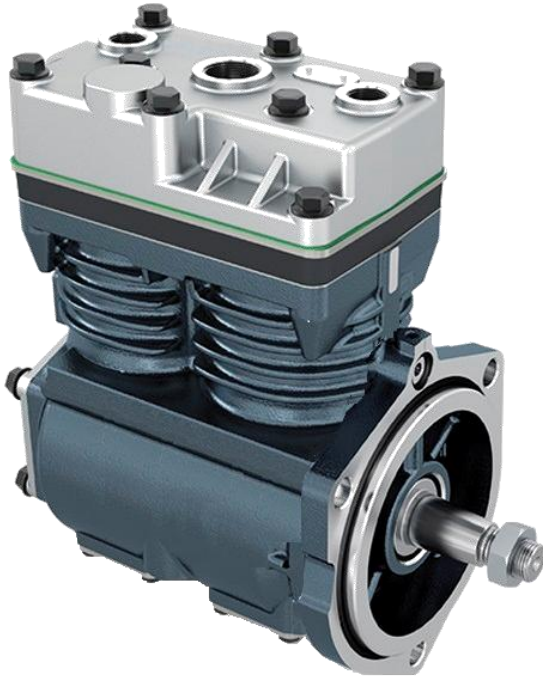
**Technical Data**

Cylinder Bore	Ø 78.00 mm
Swept Volume	500 cc
Stroke	52 mm

701.200**Complete Cylinder Head**

OEM Ref.

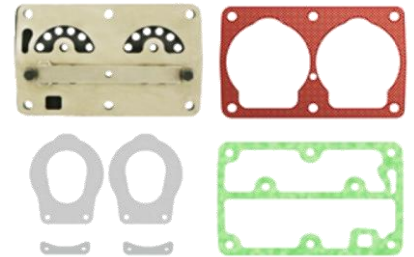
701.210**Cylinder Head**OEM Ref. SEB22583 / SEB22584 / SEB22585 / SEB22586
5001867712 / 5001867710**701.250****Plate**OEM Ref. SEB01511004 / SEB01495004
5001836883**706.150****Crankcase**

OEM Ref.

701.450**Connecting Rod**OEM Ref. SEB00859R
5001830854**701.830****Crankshaft Flange**OEM Ref. EB01490R
5001830851

ASEL CODE

403.100

OEM Reference

5021209007 / 7420569224 / 412 704 001 0 / 412 704 004 0 / 412 704 005 0

**Kullanılan Araç
Vehicle Application**

MAGNUM DXI

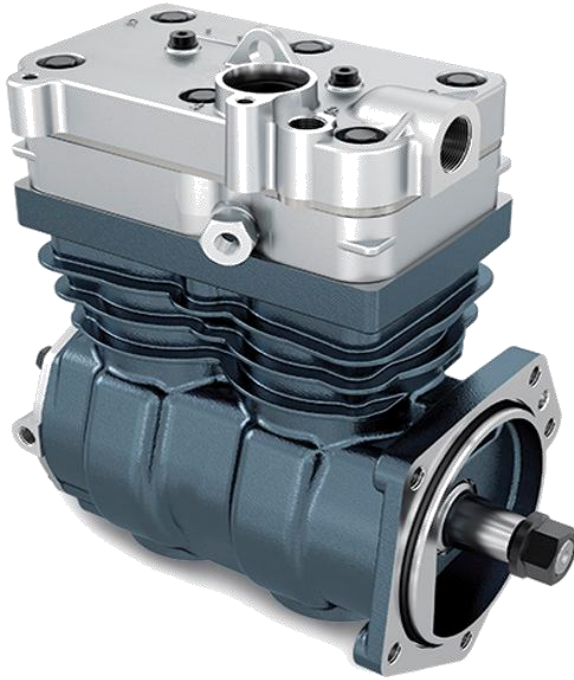

Technical Data

Cylinder Bore	Ø 85.00 mm
Swept Volume	704 cc
Stroke	62 mm

403.200

Complete Cylinder Head

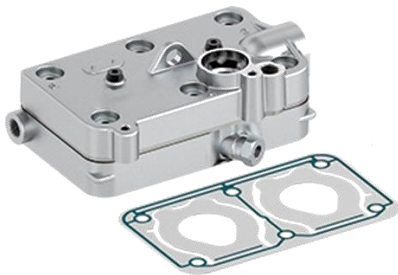

OEM Ref. 20701803 / 20701801 / 20569226
412 704 932 2 / 412 704 925 2 / 412 704 927 2

403.210

Cylinder Head



OEM Ref.

403.250

Plate



OEM Ref.

403.270

Cooling Plate



OEM Ref.

403.300

Full Repair Kit



OEM Ref.

403.310

Repair Kit

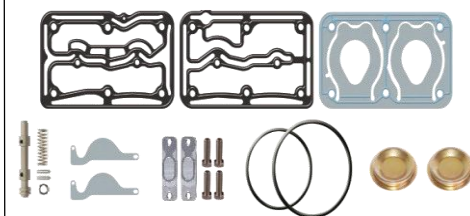

OEM Ref.

403.320 **Repair Kit**

OEM Ref.

403.350 **Gasket Kit**

OEM Ref.

403.150 **Crankcase**

OEM Ref.

403.340 **Repair Kit**

OEM Ref.

403.345 **Repair Kit**

OEM Ref.

403.355 **Gasket Kit**

OEM Ref.

101.500 **Ø 85,00 mm** **Piston**

101.510 **Ø 85,25 mm**

101.520 **Ø 85,50 mm**

OEM Ref.

101.550 **Ø 85,00 mm** **Piston & Ring**

101.560 **Ø 85,25 mm**

101.570 **Ø 85,50 mm**

OEM Ref. 0697442 / 1698686 / 128371
000 130 34 17 / 911 501 624 2 / 911 501 625 2

101.600 **Ø 85,00 mm** **Ring**

101.610 **Ø 85,25 mm**

101.620 **Ø 85,50 mm**

OEM Ref. 3094621
911 501 920 2

401.750 **Bushing**

OEM Ref.

403.800 **Crankshaft**

OEM Ref.

401.830 **Crankshaft Flange**

OEM Ref.

ASEL CODE

411.110

OEM Reference

912 514 000 0 / 912 514 001 0 / 7420774360

**Kullanılan Araç
Vehicle Application**

MAGNUM DXI12 / DXI13 / 430 / 440 / PREMIUM 420 / 440 / 450 / KERAX 440 / 450
MAGNUM EUROTECH 440 / 420

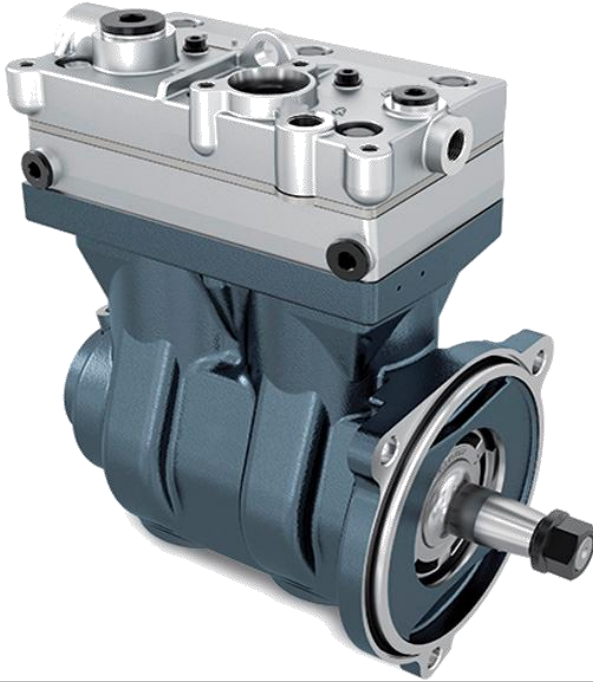

Technical Data

Cylinder Bore	Ø 85.00 mm
Swept Volume	636 cc
Stroke	56 mm

411.200

Complete Cylinder Head

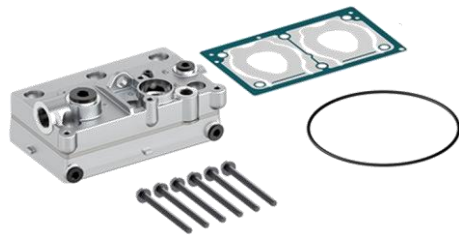

OEM Ref. 412 740 940 2 / 912 512 924 2 / 412 512 925 2
20774299 / 20889546 / 21418150 / 21707608

411.210

Cylinder Head



OEM Ref.

410.250

Plate



OEM Ref.

411.300

Full Repair Kit

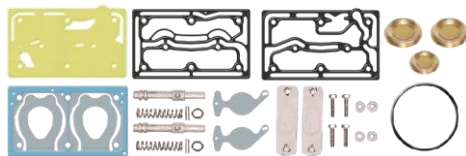

OEM Ref. 742 132 231 8
912 512 927 2

411.310

Repair Kit

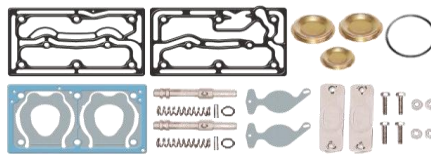

OEM Ref. 742 077 429 2 / 742 131 807 5
21322318

411.320

Repair Kit

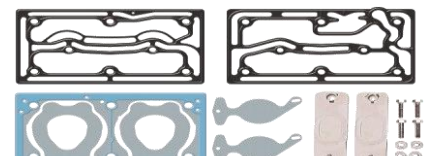

OEM Ref. 412 704 928 2

411.350 Gasket Kit

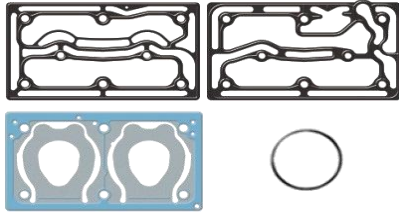

OEM Ref.

410.270 Cooling Plate



OEM Ref.

410.150 Crankcase



OEM Ref.

102.400 Valve Kit

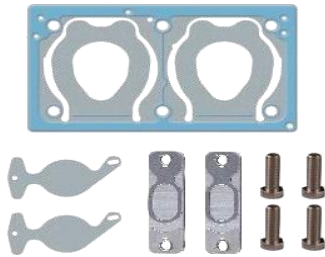

OEM Ref.

102.410 Valve Kit



OEM Ref.

118.450 Connecting Rod



OEM Ref. 3357219 / 2VF145041
000 131 24 17 / 911 145 737 2

101.500 Ø 85,00 mm Piston



OEM Ref.

101.550 Ø 85,00 mm Piston & Ring



OEM Ref. 0697442 / 1698686 / 1283781 / FBU2076
000 130 34 17 / 911 501 624 2 / 911 501 625 2

101.600 Ø 85,00 mm Ring



OEM Ref. 3094621
911 501 920 2

101.510 Ø 85,25 mm

101.560 Ø 85,25 mm

101.610 Ø 85,25 mm

101.520 Ø 85,50 mm

101.570 Ø 85,50 mm

101.620 Ø 85,50 mm

410.760 Adapter



OEM Ref. 912 003 340 4 / 912 003 340 6

410.800 Crankshaft



OEM Ref.

410.820 Gear



OEM Ref. 7403161258

ASEL CODE

411.130

OEM Reference

412 704 018 0 / 412 704 023 0

**Kullanılan Araç
Vehicle Application**

RENAULT 480

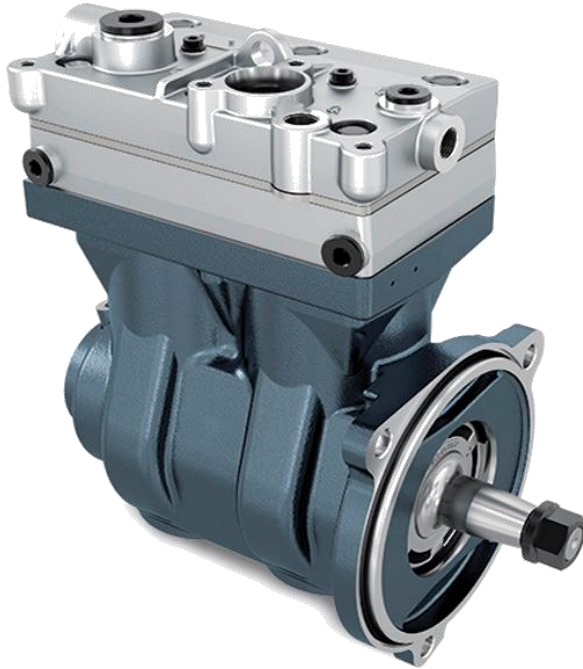

Technical Data

Cylinder Bore	Ø 85.00 mm
Swept Volume	704 cc
Stroke	62 mm

411.200

Complete Cylinder Head

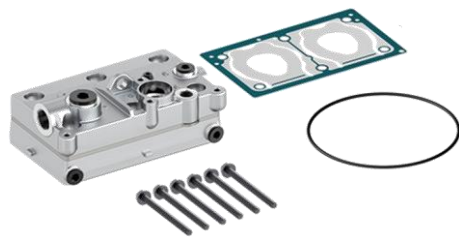

OEM Ref. 412 740 940 2 / 912 512 924 2 / 412 512 925 2
20774299 / 20889546 / 21418150 / 21707608

411.210

Cylinder Head



OEM Ref.

410.250

Plate



OEM Ref.

411.300

Full Repair Kit

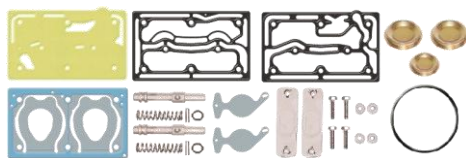

OEM Ref. 742 132 231 8
912 512 927 2

411.310

Repair Kit

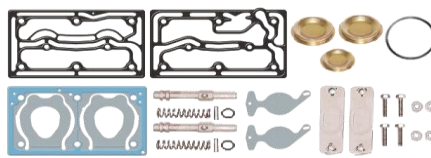

OEM Ref. 742 077 429 2 / 742 131 807 5
21322318

411.320

Repair Kit

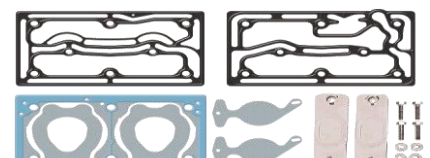

OEM Ref. 412 704 928 2

411.350 **Gasket Kit**

OEM Ref.

410.270 **Cooling Plate**

OEM Ref.

411.155 **Crankcase**

OEM Ref.

102.400 **Valve Kit**

OEM Ref.

102.410 **Valve Kit**

OEM Ref.

411.450 **Connecting Rod**

OEM Ref.

101.500 **Ø 85,00 mm** **Piston**

101.510 **Ø 85,25 mm**

101.520 **Ø 85,50 mm**

OEM Ref.

101.550 **Ø 85,00 mm** **Piston & Ring**

101.560 **Ø 85,25 mm**

101.570 **Ø 85,50 mm**

OEM Ref. 0697442 / 1698686 / 1283781 / FBU2076
000 130 34 17 / 911 501 624 2 / 911 501 625 2

101.600 **Ø 85,00 mm** **Ring**

101.610 **Ø 85,25 mm**

101.620 **Ø 85,50 mm**

OEM Ref. 3094621
911 501 920 2

410.760 **Adapter**

OEM Ref. 912 003 340 4 / 912 003 340 6

411.805 **Crankshaft**

OEM Ref.

410.820 **Gear**

OEM Ref. 7403161258

ASEL CODE	418.100
OEM Reference	912 514 009 0 / 22062019
Kullanılan Araç Vehicle Application	FH16 / FM9 / FH16II

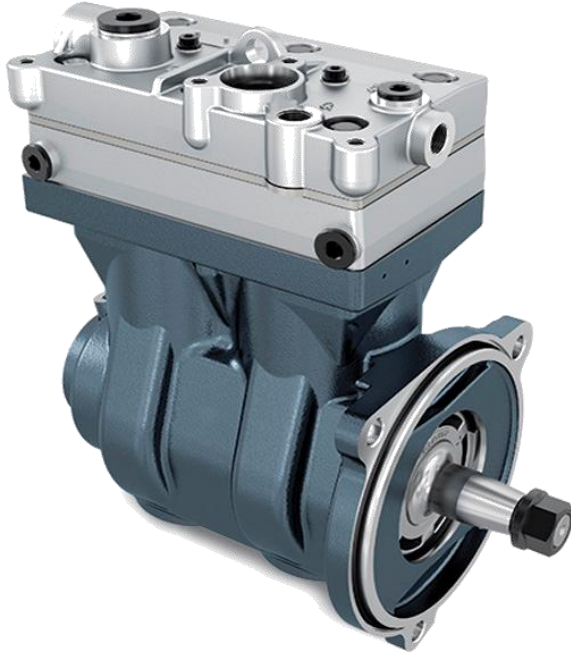

Technical Data	
Cylinder Bore	Ø 85.00 mm
Swept Volume	636 cc
Stroke	56 mm

418.200 Complete Cylinder Head

OEM Ref. 912 512 935 2

411.210 Cylinder Head

OEM Ref.

418.250 Plate

OEM Ref.

410.270 Cooling Plate

OEM Ref.

418.300 Full Repair Kit

OEM Ref.

418.310 Repair Kit

OEM Ref.

418.320 **Repair Kit**

OEM Ref.

418.330 **Repair Kit**

OEM Ref. 912 512 936 2

418.350 **Gasket Kit**

OEM Ref.

418.400 **Valve Kit**

OEM Ref.

418.410 **Valve Kit**

OEM Ref.

410.150 **Crankcase**

OEM Ref.

101.500 **Ø 85,00 mm** **Piston**

101.510 **Ø 85,25 mm**

101.520 **Ø 85,50 mm**

OEM Ref.

101.550 **Ø 85,00 mm** **Piston & Ring**

101.560 **Ø 85,25 mm**

101.570 **Ø 85,50 mm**

OEM Ref. 0697442 / 1698686 / 1283781 / FBU2076
000 130 34 17 / 911 501 624 2 / 911 501 625 2

101.600 **Ø 85,00 mm** **Ring**

101.610 **Ø 85,25 mm**

101.620 **Ø 85,50 mm**

OEM Ref. 3094621
911 501 920 2

118.450 **Connecting Rod**

OEM Ref. 3357219 / 2VF145041
000 131 24 17 / 911 145 737 2

410.800 **Crankshaft**

OEM Ref.

410.820 **Gear**

OEM Ref. 3161258

ASEL CODE

707.100

OEM Reference

412 442 000 0 / 5010550086 / 5600621115

**Kullanılan Araç
Vehicle Application**

RENAULT 420 / PREMIUM TRACTEUR / KERAX / PREMIUM PR 4X2



Technical Data

Cylinder Bore	Ø 75.00 mm
Swept Volume	442 cc
Stroke	50 mm

502.200

Complete Cylinder Head



OEM Ref. 5001859253
412 442 000 2

502.210

Cylinder Head



OEM Ref.

502.250

Plate



OEM Ref.

502.270

Cooling Plate



OEM Ref.

502.300

Full Repair Kit



OEM Ref.

502.310

Repair Kit

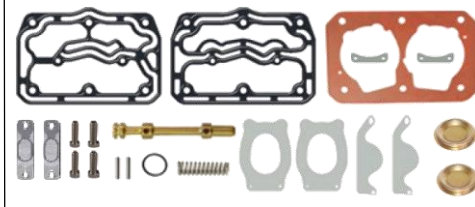

OEM Ref.

502.320 Repair Kit



OEM Ref.

502.350 Gasket Kit

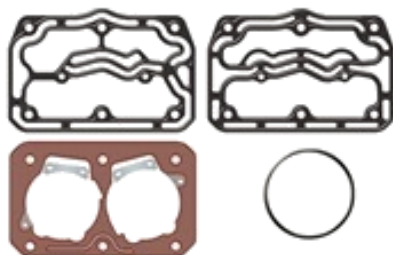

OEM Ref. 1331138 / 1743718 / 1743719
897 570 004 4 / 897 570 005 4 / 897 334 485 4

707.150 Crankcase



OEM Ref.

501.400 Valve Kit

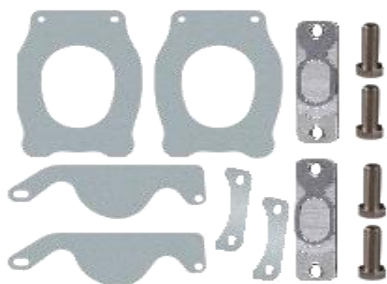

OEM Ref.

501.410 Valve Kit



OEM Ref.

501.450 Connecting Rod



OEM Ref. 1331136 / 93160591 / 41331136
911 145 735 2

501.500 Ø 75,00 mm Piston



OEM Ref.

501.550 Ø 75,00 mm Piston & Ring



OEM Ref. 0513860 / 1242704 / 5000816053 / FBU7209
411 141 623 2 / 411 522 620 2

501.510 Ø 75,25 mm

501.560 Ø 75,25 mm

501.520 Ø 75,50 mm

501.570 Ø 75,50 mm

109.600 Ø 75,00 mm Ring



OEM Ref. 1391384 / 1391385
3090388 / I801770061

109.610 Ø 75,25 mm

109.620 Ø 75,50 mm

707.835 Bearing Flange



OEM Ref.

707.800 Crankshaft



OEM Ref.

706.820 Gear



OEM Ref. 5010240933

ASEL CODE

708.100

OEM Reference

LK4979 / K088809N00 / K088809N06 / K088809N07 / 7422040616

**Kullanılan Araç
Vehicle Application**

C EURO 6 / D EURO 6

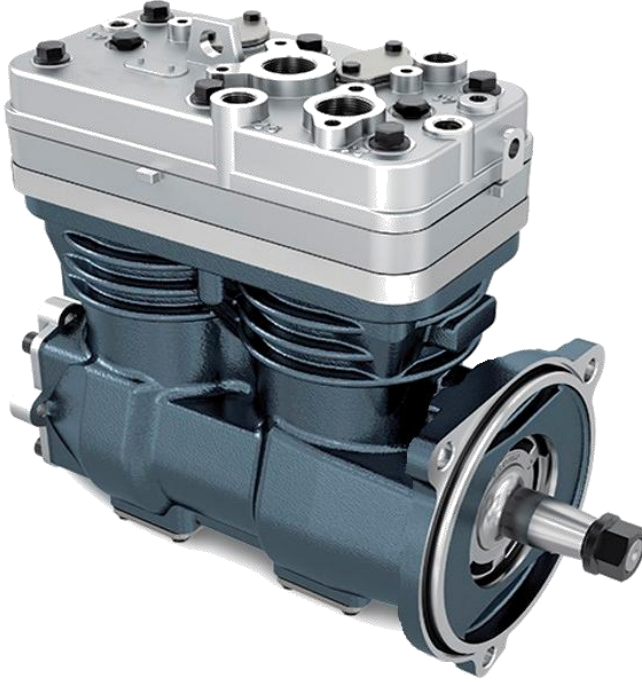

Technical Data

Cylinder Bore	Ø 92.00 mm
Swept Volume	720 cc
Stroke	54 mm

420.200

Complete Cylinder Head



OEM Ref.

420.210

Cylinder Head



OEM Ref.

417.250

Plate

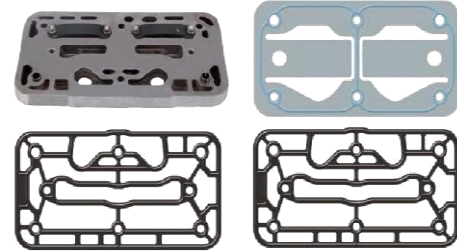

OEM Ref. 21136726 / K012074 / K099412K50

417.270

Cooling Plate



OEM Ref.

417.300

Full Repair Kit

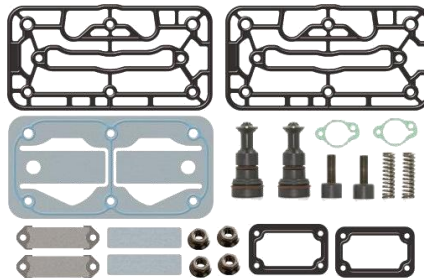

OEM Ref.

417.310

Repair Kit

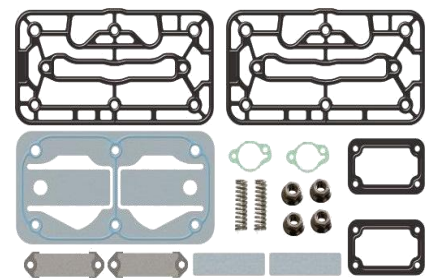

OEM Ref. K012086

417.320 Repair Kit

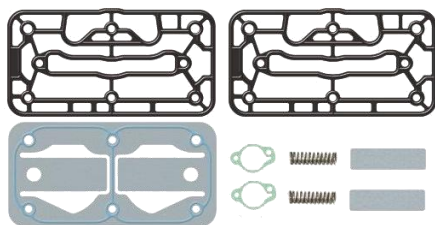

OEM Ref.

417.350 Gasket Kit

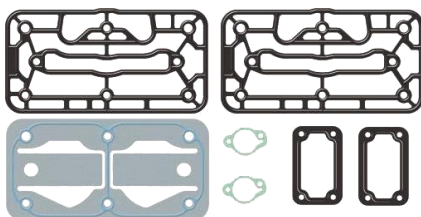

OEM Ref.

420.150 Crankcase



OEM Ref.

417.400 Valve Kit

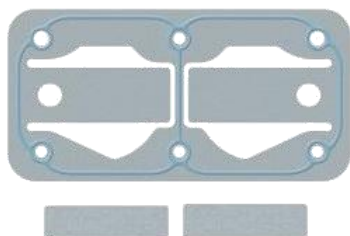

OEM Ref.

124.400 Valve Kit



OEM Ref. K03474K50 / K159064K50

302.160 Cover



OEM Ref.

214.500 Ø 92,00 mm Piston

214.510 Ø 92,25 mm

214.520 Ø 92,50 mm



OEM Ref.

214.550 Ø 92,00 mm Piston & Ring

214.560 Ø 92,25 mm

214.570 Ø 92,50 mm



OEM Ref. K006026 / K012079 / K012079K56 / K012079K57
SEB22530 / 51.54119-6008 / 51.54119-6009 / 7421136690

214.600 Ø 92,00 mm Ring

214.610 Ø 92,25 mm

214.620 Ø 92,50 mm



OEM Ref.

224.450 Connecting Rod



OEM Ref.

420.800 Crankshaft



OEM Ref.

420.830 Crankshaft Flange



OEM Ref.

ASEL CODE	419.100
OEM Reference	LK8907 / K093377N00 / K093377N06 / 7422083126
Kullanılan Araç Vehicle Application	T EURO 6 / K EURO 6 / C EURO 6



Technical Data	
Cylinder Bore	Ø 92.00 mm
Swept Volume	760 cc
Stroke	57 mm

419.250 **Plate**

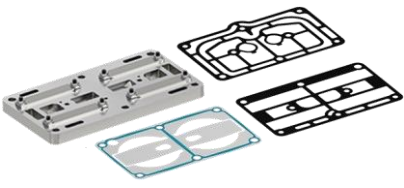

OEM Ref. 22008579
K060322K50

419.300 **Full Repair Kit**

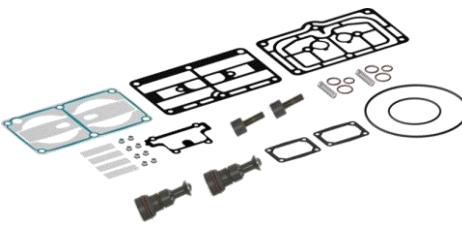

OEM Ref.

419.310 **Repair Kit**

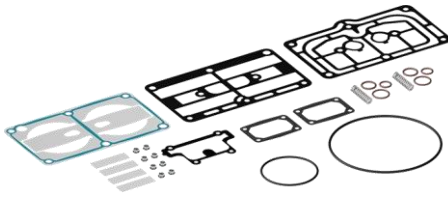

OEM Ref.

419.350 **Gasket Kit**



OEM Ref.

419.400 **Valve Kit**

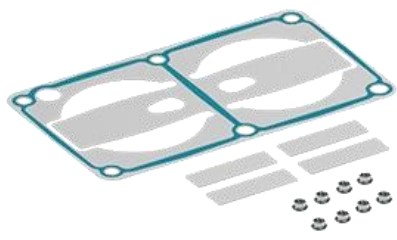

OEM Ref.

187.550 **Ø 92,00 mm** Piston & Ring

187.560 **Ø 92,25 mm**

187.570 **Ø 92,50 mm**



OEM Ref.

ASEL CODE

709.100

OEM Reference

412 442 001 0 / 5010437567

**Kullanılan Araç
Vehicle Application**

RENAULT PREMIUM / TRACTEUR KERAX / PR 4X2 MAGNUM E-TECH 400 / 440 / 480



Technical Data

Cylinder Bore	Ø 75.00 mm
Swept Volume	442 cc
Stroke	50 mm

502.200

Complete Cylinder Head



OEM Ref. 5001859253
412 442 000 2

502.210

Cylinder Head



OEM Ref.

502.250

Plate



OEM Ref.

502.300

Full Repair Kit

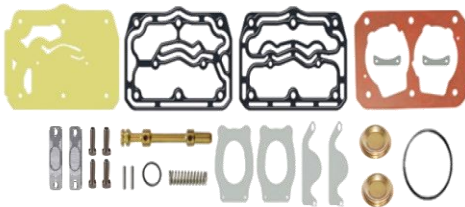

OEM Ref.

501.550

Ø 75,00 mm Piston & Ring

501.560

Ø 75,25 mm

501.570

Ø 75,50 mm



OEM Ref. 0513860 / 1242704 / 5000816053 / FBU7209
411 141 623 2 / 411 522 620 2

709.860

Adapter



OEM Ref.



IVECO

KOMPRESOR YEDEK PARÇALARI
COMPRESSOR SPARE PARTS

www.aseitr.com

İÇİNDEKİLER / INDEX

Sayfa No / Page No

IVECO

IVECO EUROSTAR 400 – 440 / EUROTECH 180 – 190	286 - 287
IVECO SPR1 HEAVY / IRISBUS EURORIDER – IRISBUS	288 - 289
STRAUS / TRAKKER / EUROTECH / EUROSTAR	290 - 291
IVECO 160.26 / 180.26 / 190.30 / 260.30 / NT 300 / 190 NC	292 - 293
EUROCARGO	294 – 295
IVECO CURSOR 13 ENGINE / STRALIS SERIES	296 - 297
IVECO CITYCLASS 491 / 591 IRIBUS CITELIS SERIES / LINE SERIES	298 - 299
CURSOR 13 ENGINE / STRALIS SERIES	300 - 301
CITYCLASS 491 / 591 / IRIBUS SERIES	302 - 303
TECTOR / EUROCARGO / EUROFIRE	304 - 305
EUROCARGO	306 - 307

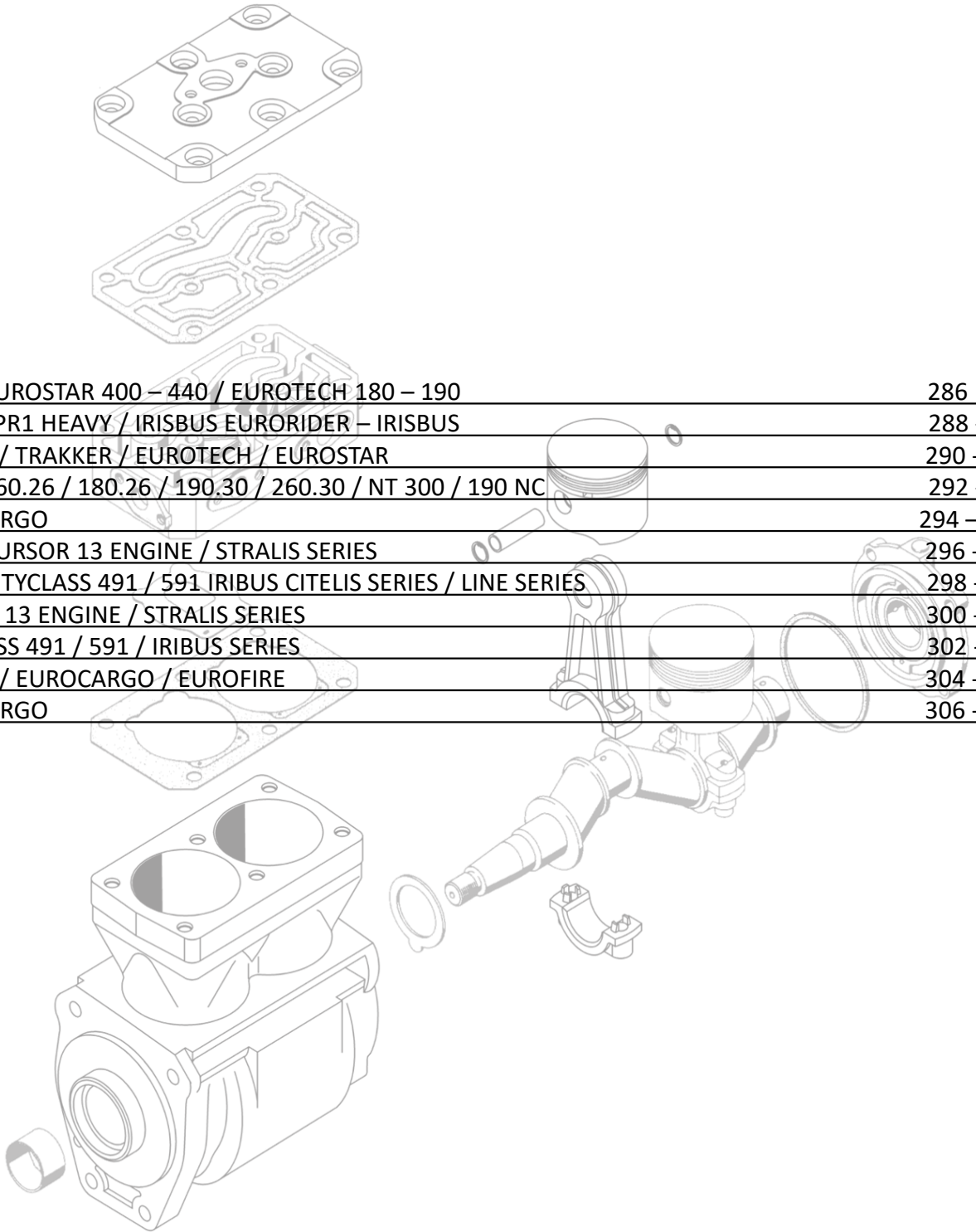

ASEL CODE	801.100
OEM Reference	ACX83D / 500310903
Kullanılan Araç Vehicle Application	IVECO EUROSTAR 400 – 440 / EUROTECH 180 - 190

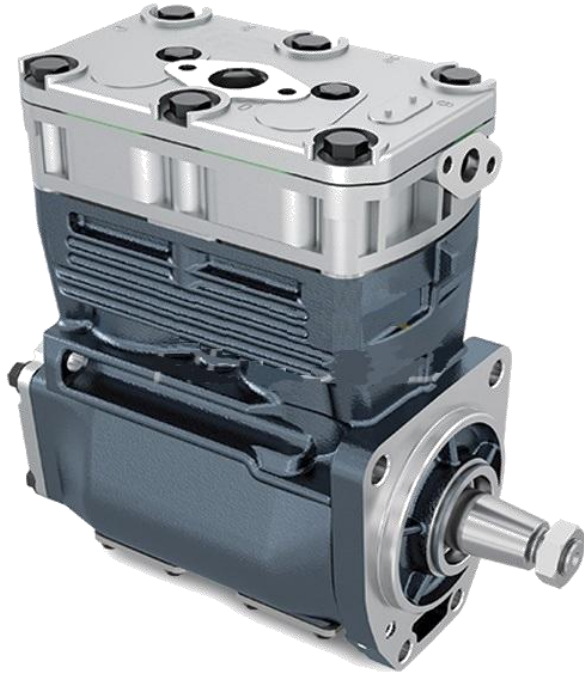

Technical Data	
Cylinder Bore	Ø 82.00 mm
Swept Volume	600 cc
Stroke	56 mm

801.200 Complete Cylinder Head



OEM Ref. K029208K50 / K029207K50
93161842 / 93162116

801.210 Cylinder Head



OEM Ref.

801.250 Plate



OEM Ref.

801.300 Full Repair Kit

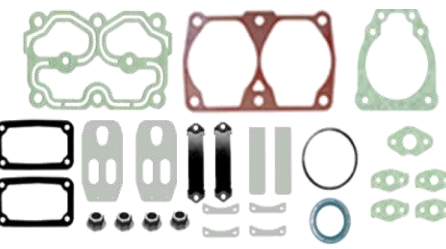

OEM Ref.

801.310 Repair Kit



OEM Ref.

801.320 Repair Kit



OEM Ref. 93161411 / 76628601

801.350 **Gasket Kit**

OEM Ref.

801.400 **Valve Kit**

OEM Ref.

801.150 **Crankcase**

OEM Ref.

407.160 **Cover**

407.165 **Cover**

OEM Ref.

702.450 **Connecting Rod**

OEM Ref.

702.750 **Bushing**

OEM Ref.

801.500 **Ø 82,00 mm** **Piston**

801.510 **Ø 82,25 mm**

801.520 **Ø 82,50 mm**

OEM Ref. 93161412

801.550 **Ø 82,00 mm** **Piston & Ring**

801.560 **Ø 82,25 mm**

801.570 **Ø 82,50 mm**

OEM Ref.

801.600 **Ø 82,00 mm** **Ring**

801.610 **Ø 82,25 mm**

801.620 **Ø 82,50 mm**

OEM Ref. 93161415

801.800 **Crankshaft**

OEM Ref.

801.820 **Gear**

OEM Ref.

801.830 **Crankshaft Flange**

OEM Ref. 93159347

ASEL CODE

801.110

OEM Reference

ACX83DX / K007304 / 500329513

**Kullanılan Araç
Vehicle Application**

IVECO SPR1 HEAVY / IRISBUS EURORIDER - IRISBUS

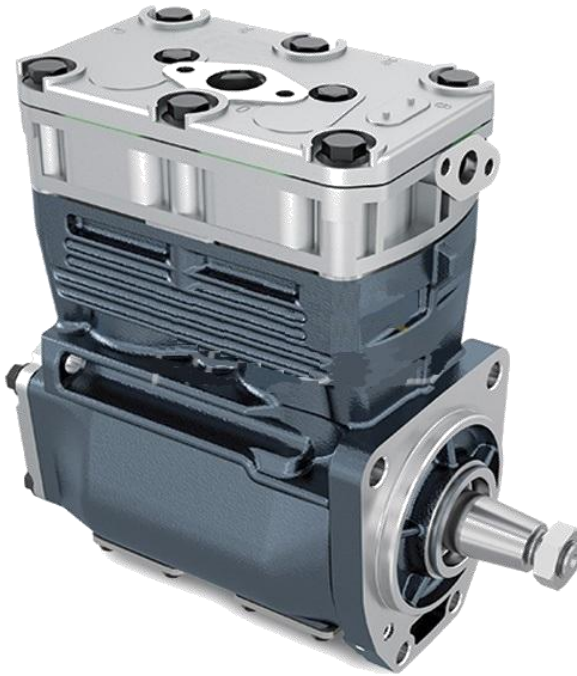

Technical Data

Cylinder Bore	Ø 82.00 mm
Swept Volume	600 cc
Stroke	56 mm

801.200

Complete Cylinder Head



OEM Ref. K029208K50 / K029207K50
93161842 / 93162116

801.210

Cylinder Head



OEM Ref.

801.250

Plate



OEM Ref.

801.300

Full Repair Kit

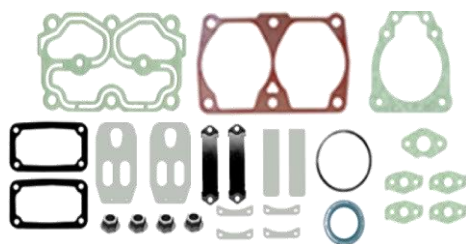

OEM Ref.

801.310

Repair Kit

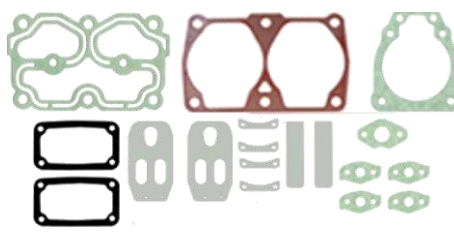

OEM Ref.

801.320

Repair Kit

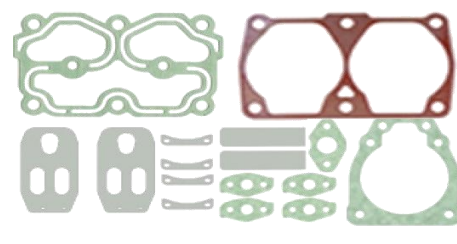

OEM Ref. 93161411 / 76628601

801.350 **Gasket Kit**

OEM Ref.

801.400 **Valve Kit**

OEM Ref.

801.150 **Crankcase**

OEM Ref.

407.160 **Cover**

407.165 **Cover**

702.450 **Connecting Rod**

OEM Ref.

702.750 **Bushing**

OEM Ref.

801.500 **Ø 82,00 mm** **Piston**

801.510 **Ø 82,25 mm**

801.520 **Ø 82,50 mm**

OEM Ref. 93161412

801.550 **Ø 82,00 mm** **Piston & Ring**

801.560 **Ø 82,25 mm**

801.570 **Ø 82,50 mm**

OEM Ref.

801.600 **Ø 82,00 mm** **Ring**

801.610 **Ø 82,25 mm**

801.620 **Ø 82,50 mm**

OEM Ref. 93161415

801.810 **Crankshaft**

OEM Ref.

801.820 **Gear**

OEM Ref.

801.835 **Crankshaft Flange**

OEM Ref. 93159347

ASEL CODE	802.100
OEM Reference	412 352 008 0 / 412 352 020 0 / 41211219 / 41211220 / 504308489
Kullanılan Araç Vehicle Application	STRAUS / TRAKKER / EUROTECH / EUROSTAR



Technical Data	
Cylinder Bore	Ø 85.00 mm
Swept Volume	352 cc
Stroke	62 mm

802.200 Complete Cylinder Head

OEM Ref.

802.210 Cylinder Head

OEM Ref.

802.250 Plate

OEM Ref.

802.300 Full Repair Kit

OEM Ref.

802.310 Repair Kit

OEM Ref.

802.320 Repair Kit

OEM Ref.

802.350 Gasket Kit

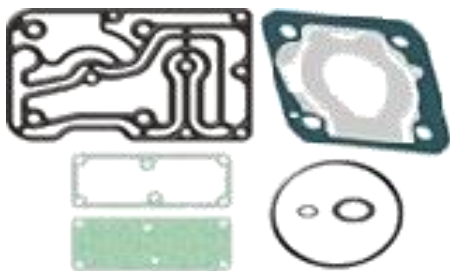

OEM Ref.

213.400 Valve Kit



OEM Ref.

101.410 Valve Kit

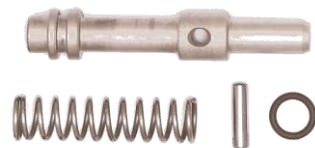

OEM Ref.

802.150 Crankcase



OEM Ref.

101.450 Connecting Rod



OEM Ref.

802.800 Crankshaft



OEM Ref.

801.500 Ø 82,00 mm Piston

801.510 Ø 82,25 mm

801.520 Ø 82,50 mm



OEM Ref. 93161412

801.550 Ø 82,00 mm Piston & Ring

801.560 Ø 82,25 mm

801.570 Ø 82,50 mm



OEM Ref.

801.600 Ø 82,00 mm Ring

801.610 Ø 82,25 mm

801.620 Ø 82,50 mm



OEM Ref. 93161415

802.810 Crankshaft



OEM Ref.

802.860 Adapter



OEM Ref.

501.750 Bushing



OEM Ref. 1315390 / 3291442r1 / 01306569 / 4285416
000 131 21 50 / 81.54121-005 / 411 522 340 4

ASEL CODE	803.100
OEM Reference	ACX67 / 4802598 / 99440235
Kullanılan Araç Vehicle Application	IVECO 160.26 / 180.26 / 190.30 / 260.30 / NT 300 / 190 NC

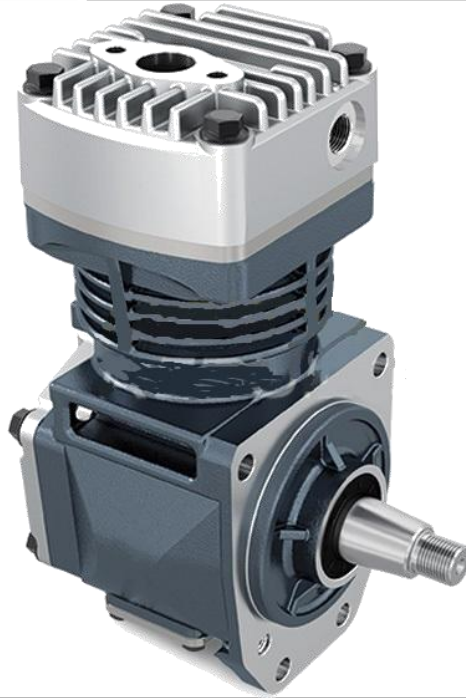

Technical Data	
Cylinder Bore	Ø 80.00 mm
Swept Volume	250 cc
Stroke	50 mm

803.200 Complete Cylinder Head

OEM Ref.

803.210 Cylinder Head

OEM Ref.

803.250 Plate

OEM Ref.

803.300 Full Repair Kit

OEM Ref.

803.320 Repair Kit

OEM Ref.

803.350 Gasket Kit

OEM Ref.

803.400 **Valve Kit**

OEM Ref.

803.150 **Crankcase**

OEM Ref.

803.450 **Connecting Rod**

OEM Ref.

803.750 **Bushing**

OEM Ref.

803.800 **Crankshaft**

OEM Ref.

803.830 **Crankshaft Flange**

OEM Ref.

803.500 **Ø 80,00 mm** **Piston**

803.510 **Ø 80,25 mm**

803.520 **Ø 80,50 mm**

OEM Ref.

803.550 **Ø 80,00 mm** **Piston & Ring**

803.560 **Ø 80,25 mm**

803.570 **Ø 80,50 mm**

OEM Ref.

803.600 **Ø 80,00 mm** **Ring**

803.610 **Ø 80,25 mm**

803.620 **Ø 80,50 mm**

OEM Ref.

OEM Ref.

OEM Ref.

OEM Ref.

ASEL CODE**804.100****OEM Reference**

ACX69D / 500310901 / 9846501

**Kullanılan Araç
Vehicle Application**

EUROCARGO

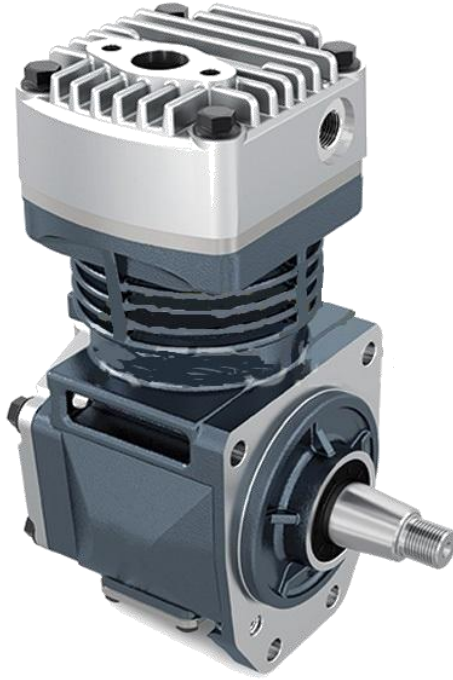
**Technical Data**

Cylinder Bore	Ø 80.00 mm
Swept Volume	250 cc
Stroke	50 mm

804.200**Complete Cylinder Head**

OEM Ref.

804.210**Cylinder Head**

OEM Ref.

804.250**Plate**

OEM Ref.

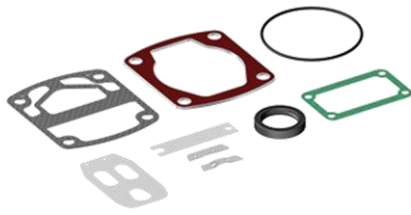
804.300**Full Repair Kit**

OEM Ref.

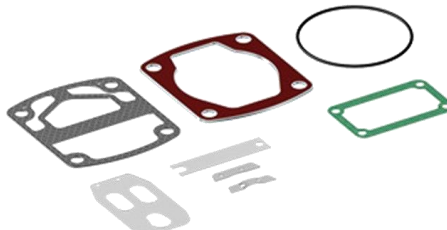
804.320**Repair Kit**

OEM Ref.

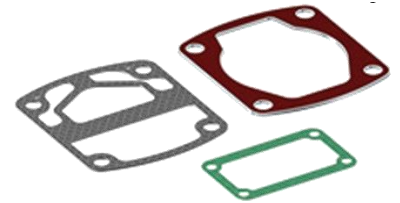
804.350**Gasket Kit**

OEM Ref.

804.400 **Valve Kit**



OEM Ref.

804.150 **Crankcase**



OEM Ref.

804.450 **Connecting Rod**



OEM Ref.

804.750 **Bushing**



OEM Ref.

804.800 **Crankshaft**



OEM Ref.

804.830 **Crankshaft Flange**



OEM Ref.

803.500 **Ø 80,00 mm** **Piston**

803.510 **Ø 80,25 mm**

803.520 **Ø 80,50 mm**



OEM Ref.

803.550 **Ø 80,00 mm** **Piston & Ring**

803.560 **Ø 80,25 mm**

803.570 **Ø 80,50 mm**



OEM Ref.

803.600 **Ø 80,00 mm** **Ring**

803.610 **Ø 80,25 mm**

803.620 **Ø 80,50 mm**



OEM Ref.

OEM Ref.

OEM Ref.

OEM Ref.

ASEL CODE

805.100

OEM Reference

LK4936 / LK4969 / K022263N00 / K031813N00 / 504293730 / 5801216167

**Kullanılan Araç
Vehicle Application**

IVECO CURSOR 13 ENGINE / STRALIS SERIES

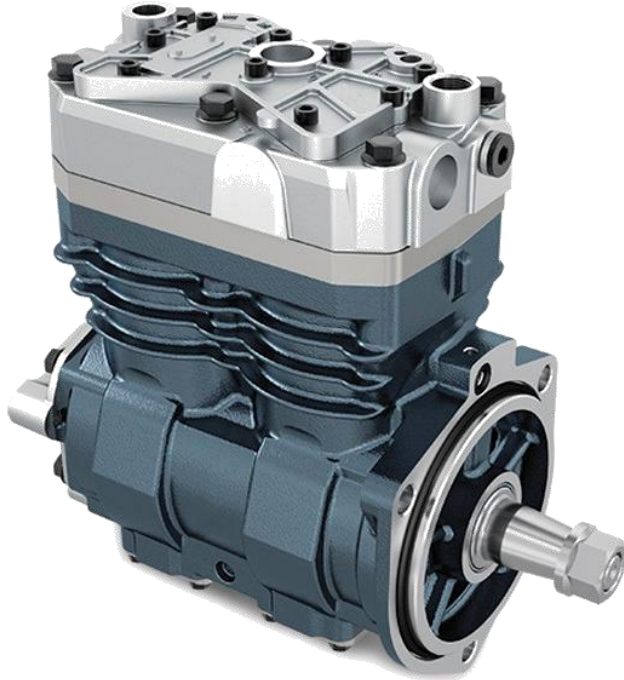

Technical Data

Cylinder Bore	Ø 86.00 mm
Swept Volume	630 cc
Stroke	54 mm

805.200

Complete Cylinder Head



OEM Ref.

805.210

Cylinder Head



OEM Ref. K041489K50 / K057166K50
42562098

306.250

Plate

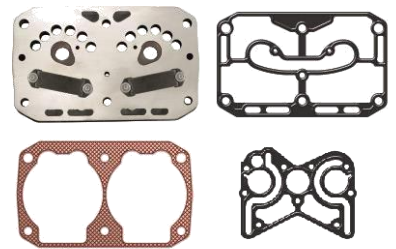

OEM Ref. 8C462B956AA / K041488K50

306.300

Full Repair Kit

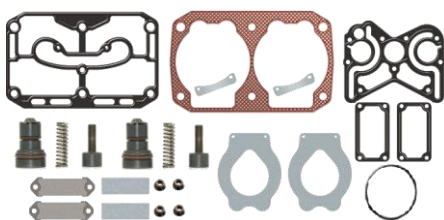

OEM Ref. SEB22549 / 42549150

306.310

Repair Kit

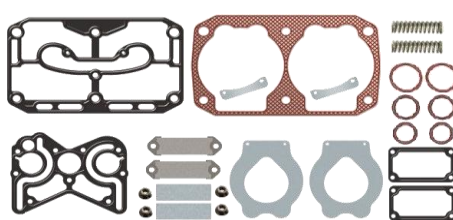

OEM Ref.

306.320

Repair Kit

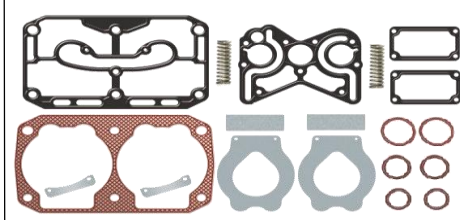

OEM Ref. K083735K50

306.350 **Gasket Kit**

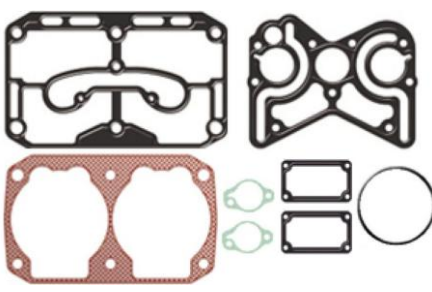

OEM Ref. SEB22550

305.400 **Valve Kit**



OEM Ref.

306.410 **Valve Kit**



OEM Ref.

305.150 **Crankcase**



OEM Ref.

305.160 **Cover**



OEM Ref.

214.450 **Connecting Rod**



OEM Ref. SEB22464 / EB02800

124.500 **Ø 86,00 mm** **Piston**

124.510 **Ø 86,25 mm**

124.520 **Ø 86,50 mm**



OEM Ref.

124.550 **Ø 86,00 mm** **Piston & Ring**

124.560 **Ø 86,25 mm**

124.570 **Ø 86,50 mm**



OEM Ref. SEB22547 / SEB22548 / 42549147

124.600 **Ø 86,00 mm** **Ring**

124.610 **Ø 86,25 mm**

124.620 **Ø 86,50 mm**



OEM Ref.

305.750 **Bushing**



OEM Ref.

305.800 **Crankshaft**



OEM Ref.

805.830 **Crankshaft Flange**



OEM Ref.

ASEL CODE

806.100

OEM Reference

LK4952 / K022264N00 / 504079460 / 504353252

**Kullanılan Araç
Vehicle Application**

IVECO CITYCLASS 491 / 591 IRIBUS CITELIS SERIES / LINE SERIES



Technical Data

Cylinder Bore	Ø 86.00 mm
Swept Volume	630 cc
Stroke	54 mm

806.200

Complete Cylinder Head

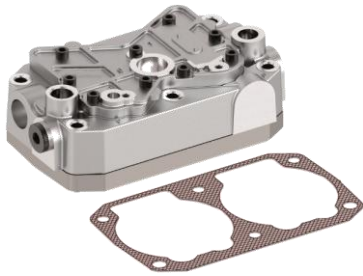

OEM Ref.

806.210

Cylinder Head



OEM Ref.

306.250

Plate

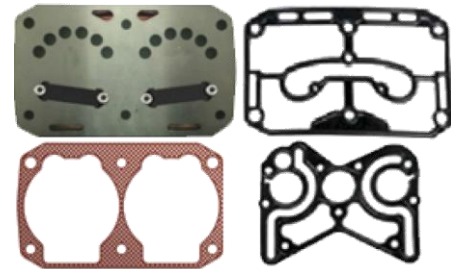

OEM Ref. K04410K50

359.300

Full Repair Kit



OEM Ref.

359.310

Repair Kit

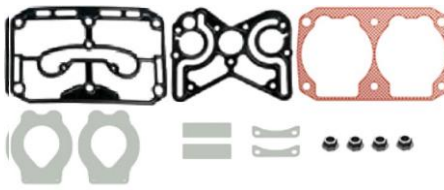

OEM Ref.

359.320

Repair Kit

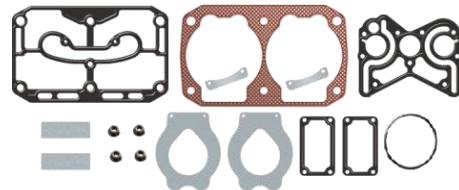

OEM Ref.

359.350 **Gasket Kit**

OEM Ref.

305.400 **Valve Kit**

OEM Ref.

305.150 **Crankcase**

OEM Ref.

305.160 **Cover**

OEM Ref.

359.165 **Cylinder Head Cover**

OEM Ref.

214.450 **Connecting Rod**

OEM Ref. SEB22464 / EB02800

124.500 **Ø 86,00 mm** **Piston**

124.510 **Ø 86,25 mm**

124.520 **Ø 86,50 mm**

OEM Ref.

124.550 **Ø 86,00 mm** **Piston & Ring**

124.560 **Ø 86,25 mm**

124.570 **Ø 86,50 mm**

OEM Ref. SEB22547 / SEB22548 / 42549147

124.600 **Ø 86,00 mm** **Ring**

124.610 **Ø 86,25 mm**

124.620 **Ø 86,50 mm**

OEM Ref.

305.750 **Bushing**

OEM Ref.

806.800 **Crankshaft**

OEM Ref.

805.830 **Crankshaft Flange**

OEM Ref.

ASEL CODE	807.100
OEM Reference	LK4936 / K001126 / K001126000 / 41211340 / 41211122 / 99471919
Kullanılan Araç Vehicle Application	CURSOR 13 ENGINE / STRALIS SERIES

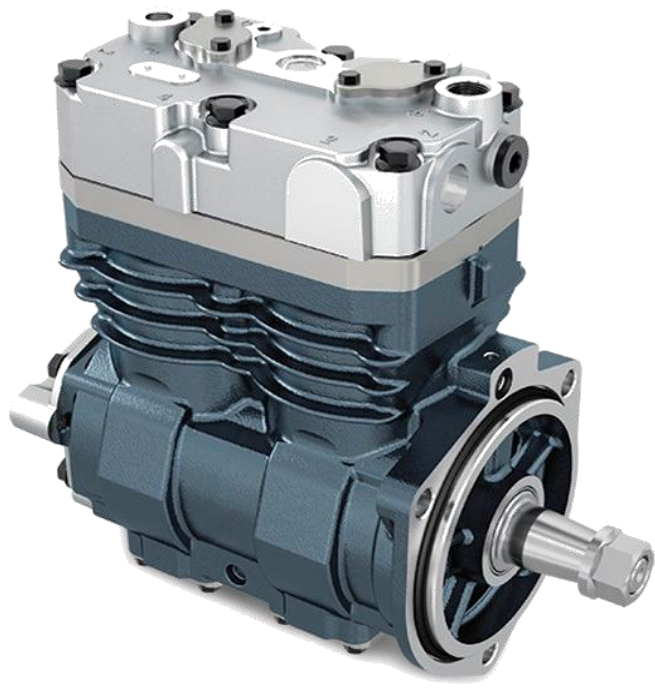

Technical Data	
Cylinder Bore	Ø 86.00 mm
Swept Volume	630 cc
Stroke	54 mm

807.200 Complete Cylinder Head



OEM Ref.

807.210 Cylinder Head



OEM Ref. SEB01851004 / 42549152

807.250 Plate



OEM Ref. 42549149

305.300 Full Repair Kit



OEM Ref. SEB22549 / 42549150

305.310 Repair Kit



OEM Ref.

305.320 Repair Kit

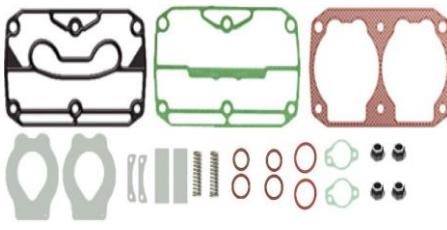

OEM Ref.

305.350 Gasket Kit

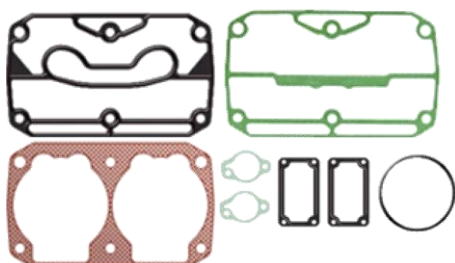

OEM Ref. 42549151

305.400 Valve Kit



OEM Ref.

305.410 Valve Kit



OEM Ref.

305.150 Crankcase



OEM Ref.

305.160 Cover



OEM Ref.

214.450 Connecting Rod



OEM Ref. SEB22464 / EB02800

124.500 Ø 86,00 mm Piston



OEM Ref.

124.550 Ø 86,00 mm Piston & Ring



OEM Ref. SEB22547 / SEB22548 / 42549147

124.600 Ø 86,00 mm Ring



OEM Ref.

124.510 Ø 86,25 mm

124.560 Ø 86,25 mm

124.610 Ø 86,25 mm

124.520 Ø 86,50 mm

124.570 Ø 86,50 mm

124.620 Ø 86,50 mm

305.750 Bushing



OEM Ref.

305.800 Crankshaft



OEM Ref.

805.830 Crankshaft Flange



OEM Ref.

ASEL CODE	808.100
OEM Reference	LK4952 / 504033988
Kullanılan Araç Vehicle Application	CITYCLASS 491 / 591 / IRIBUS SERIES

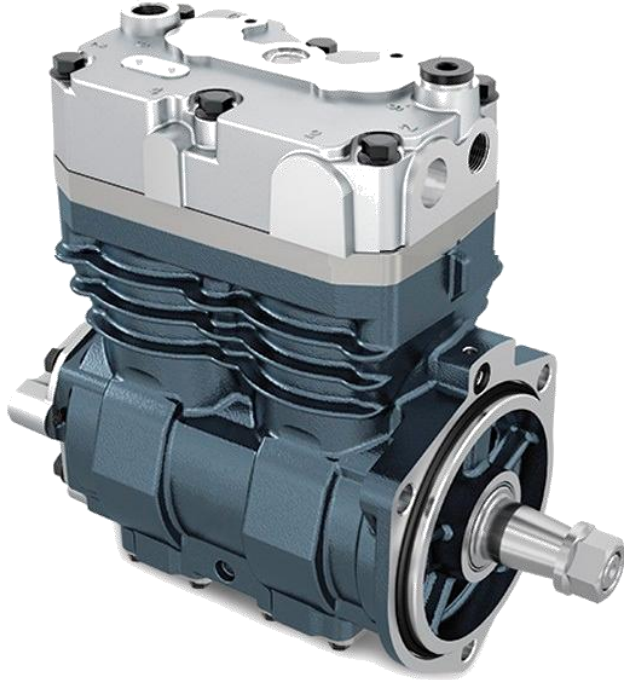

Technical Data	
Cylinder Bore	Ø 86.00 mm
Swept Volume	630 cc
Stroke	54 mm

808.200 Complete Cylinder Head

OEM Ref.

808.210 Cylinder Head

OEM Ref.

808.250 Plate

OEM Ref. 42549149

357.300 Full Repair Kit

OEM Ref.

357.320 Repair Kit

OEM Ref.

357.350 Repair Kit

OEM Ref.

305.150

Crankcase



OEM Ref.

305.400

Valve Kit



OEM Ref.

214.450

Connecting Rod



OEM Ref. SEB22464 / EB02800

305.750

Bushing



OEM Ref.

306.800

Crankshaft



OEM Ref.

805.830

Crankshaft Flange



OEM Ref. SEB22464 / EB02800

124.500

Ø 86,00 mm

Piston

124.510

Ø 86,25 mm

124.520

Ø 86,50 mm



OEM Ref.

124.550

Ø 86,00 mm

Piston & Ring

124.560

Ø 86,25 mm

124.570

Ø 86,50 mm



OEM Ref. SEB22547 / SEB22548 / 42549147

124.600

Ø 86,00 mm

Ring

124.610

Ø 86,25 mm

124.620

Ø 86,50 mm



OEM Ref.

OEM Ref.

OEM Ref.

OEM Ref.

ASEL CODE**809.100****OEM Reference**

LK3840 / 504016815 / 4897300

**Kullanılan Araç
Vehicle Application**

TECTOR / EUROCARGO / EUROFIRE

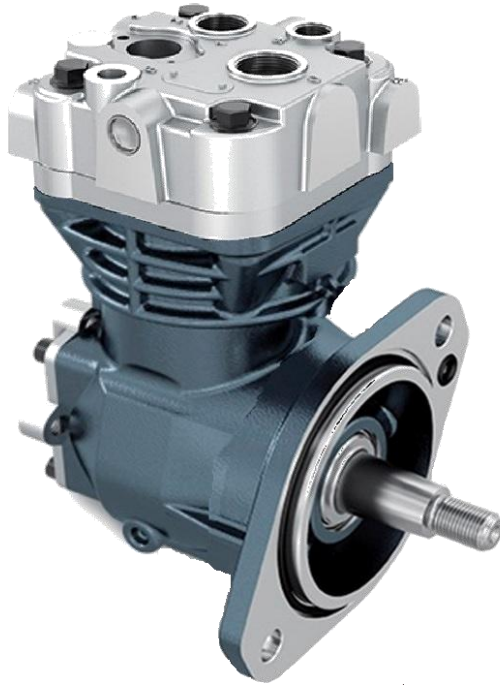
**Technical Data**

Cylinder Bore	Ø 80.00 mm
Swept Volume	225 cc
Stroke	45 mm

809.200**Complete Cylinder Head**

OEM Ref.

809.250**Cylinder Head**

OEM Ref.

358.250**Plate**

OEM Ref.

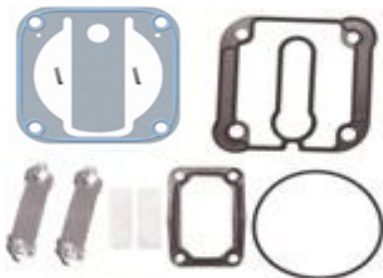
358.300**Full Repair Kit**

OEM Ref.

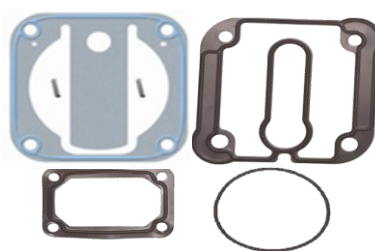
358.350**Gasket Kit**

OEM Ref.

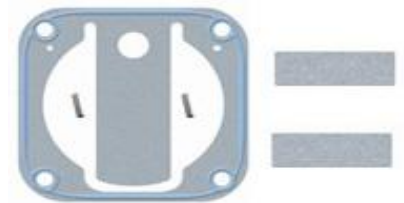
305.400**Valve Kit**

OEM Ref.

809.150 **Crankcase**



OEM Ref.

305.160 **Cover**



OEM Ref.

214.450 **Connecting Rod**



OEM Ref. SEB22464 / EB02800

302.750 **Bushing**



OEM Ref.

302.800 **Crankshaft**



OEM Ref.

809.830 **Crankshaft Flange**



OEM Ref.

302.500 **Ø 80,00 mm** **Piston**

302.510 **Ø 85,25 mm**

302.520 **Ø 85,50 mm**



OEM Ref.

302.550 **Ø 80,00 mm** **Piston & Ring**

302.560 **Ø 80,25 mm**

302.570 **Ø 80,50 mm**



OEM Ref.

302.600 **Ø 80,00 mm** **Ring**

302.610 **Ø 80,25 mm**

302.620 **Ø 80,50 mm**



OEM Ref. SEB22517

OEM Ref.

OEM Ref.

OEM Ref.

ASEL CODE	810.100
OEM Reference	LP3974 / K017428 / 7C46 2875 BA
Kullanılan Araç Vehicle Application	EUROCARGO



Technical Data	
Cylinder Bore	Ø 92.00 mm
Swept Volume	360 cc
Stroke	54 mm

810.200 Complete Cylinder Head



OEM Ref.

810.210 Cylinder Head



OEM Ref.

214.270 Coolin Plate



OEM Ref.

810.250 Plate



OEM Ref. 42471271
SEB01694004

810.300 Full Repair Kit



OEM Ref.

810.320 Repair Kit



OEM Ref. SEB22532
42547020

810.350 Gasket Kit

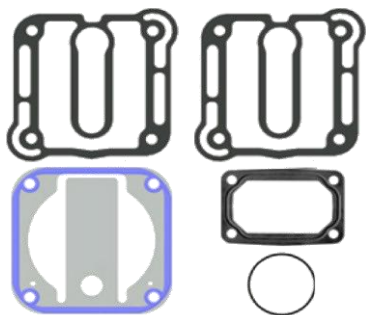

OEM Ref.

303.400 Valve Kit

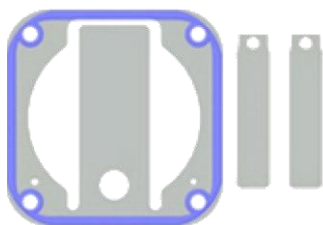

OEM Ref.

810.150 Crankcase



OEM Ref.

302.160 Cover



OEM Ref.

214.450 Connecting Rod



OEM Ref. SEB22464 / EB02800

405.750 Bushing



OEM Ref.

214.500 Ø 92,00 mm Piston

214.510 Ø 92,25 mm

214.520 Ø 92,50 mm



OEM Ref.

214.550 Ø 92,00 mm Piston & Ring

214.560 Ø 92,25 mm

214.570 Ø 92,50 mm



OEM Ref. 51.54119-6008 / 51.54119-6009
K006026 / K012079 / K012079K56 / SEB22530

214.600 Ø 92,00 mm Ring

214.610 Ø 92,25 mm

214.620 Ø 92,50 mm



OEM Ref.

303.800 Crankshaft



OEM Ref.

809.830 Crankshaft Flange



OEM Ref.

OEM Ref.

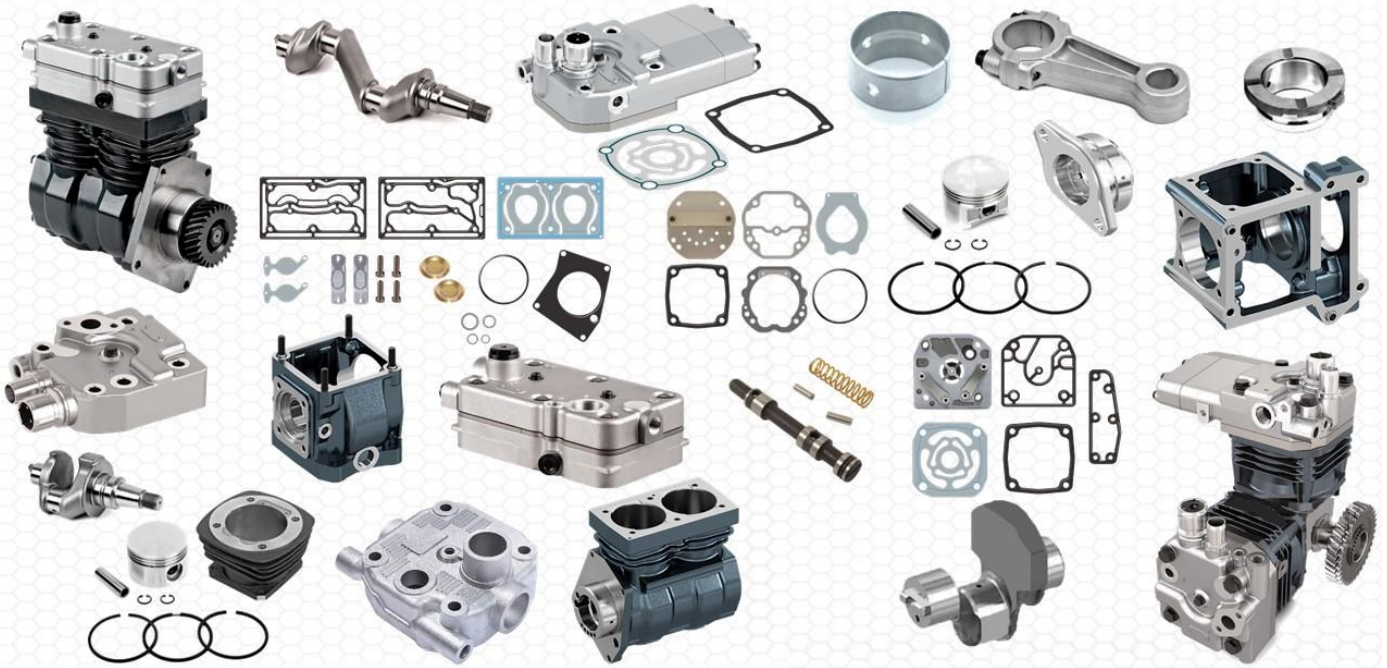

Web : www.aseltr.com

Air Brake Compressor
E-mail : info@aseltr.com

Gücünüze güç, işinize değer katar..

Adds power your strength, adds value to your business...

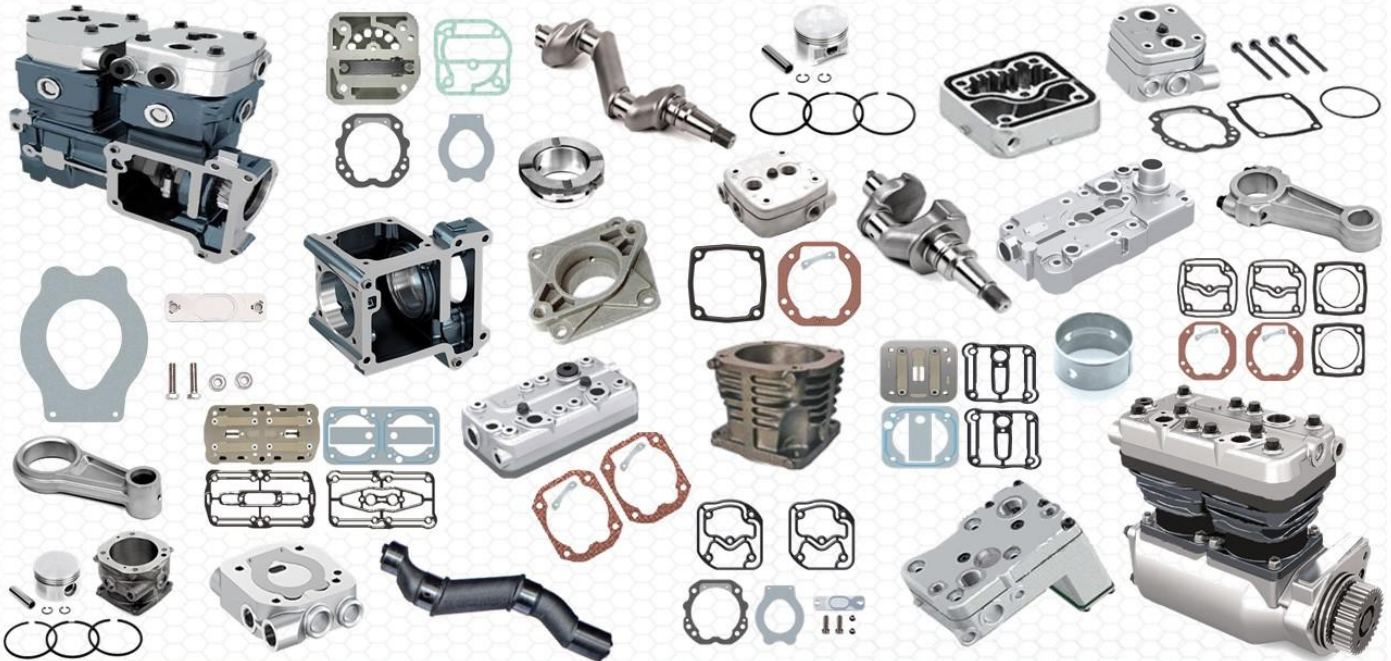

Web : www.aseltr.com

Air Brake Compressor
E-mail : info@aseltr.com

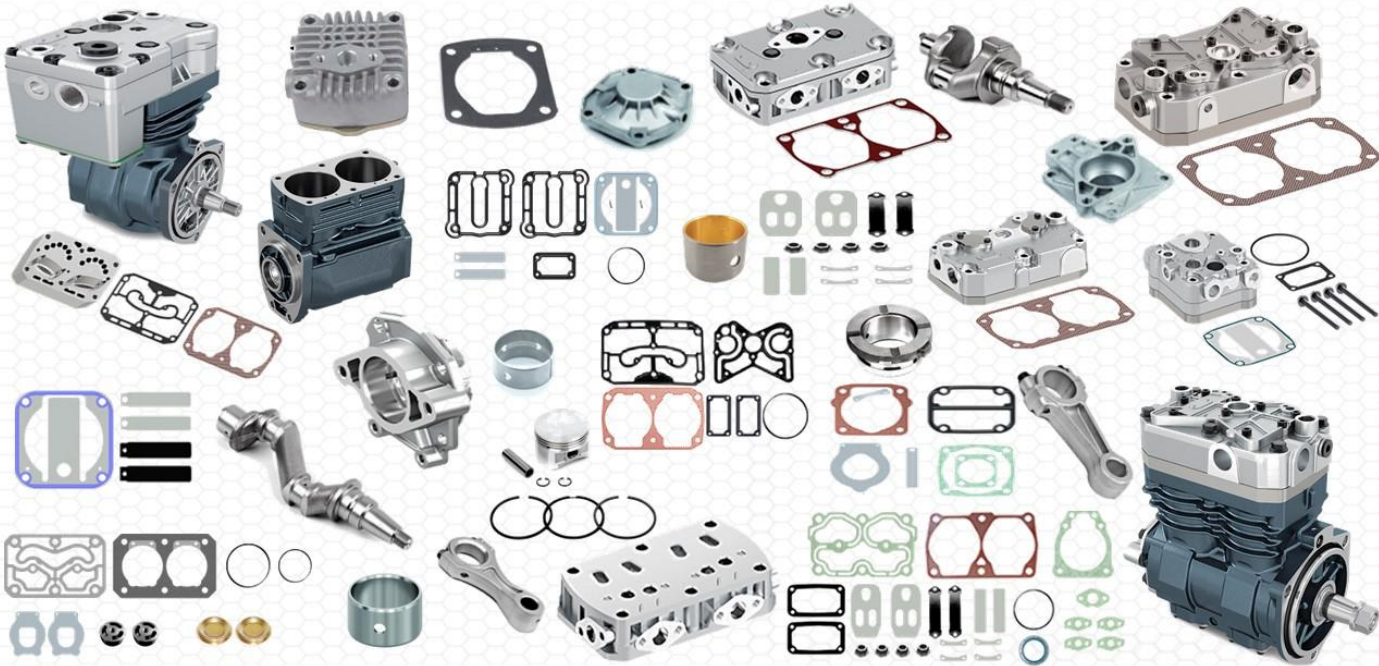

Web : www.aseltr.com

Air Brake Compressor
E-mail : info@aseltr.com

Gücünüze güç, işinize değer katar..

Adds power your strength, adds value to your business...

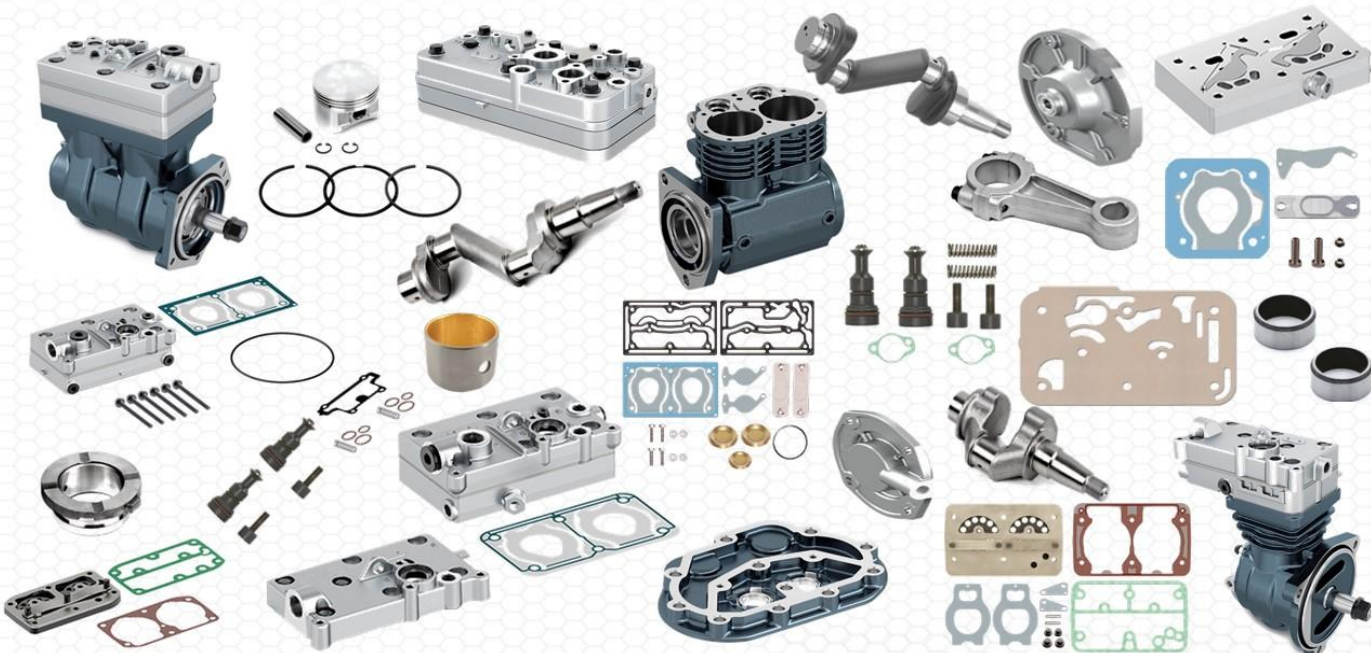

Web : www.aseltr.com

Air Brake Compressor
E-mail : info@aseltr.com



Web: www.aseeltr.com

Air Brake Compressor
E-mail: info@aseeltr.com

Gücünüze güç, işinize değer katar..

Adds power your strength, adds value to your business...



Web: www.aseeltr.com

Air Brake Compressor
E-mail: info@aseeltr.com



Web : www.aseeltr.com

Gasket Components
E-mail : info@aseeltr.com

Gücünüze güç, işinize değer katar..

Adds power your strength, adds value to your business...



Web : www.aseeltr.com

Air Disc Brake Caliper
E-mail : info@aseeltr.com



Power in Your Brakes

İletişim Bilgileri

ASEL TAŞKAN OTOMOTİV SANAYİ ve TİC. LTD. ŞTİ

Dudullu Organize Sanayi Bölgesi

3.Cadde No : 5 / 78 Ümraniye / İSTANBUL

+90 216 313 83 23

info@aseltr.com

+90 532 440 59 23

www.aseltr.com

[aselairbrakesystems](https://www.instagram.com/aselairbrakesystems)

[facebook.com/asel](https://www.facebook.com/asel)